

INSPIRIA™

6 736 00/01/02/03/10/11/12/13/20/21/22/23/30/31/32/33/40/41/42/43/50/51/52/53
 6 736 60/61/62/63/70/71/72/73/80/81/82/83/90/91/92/93

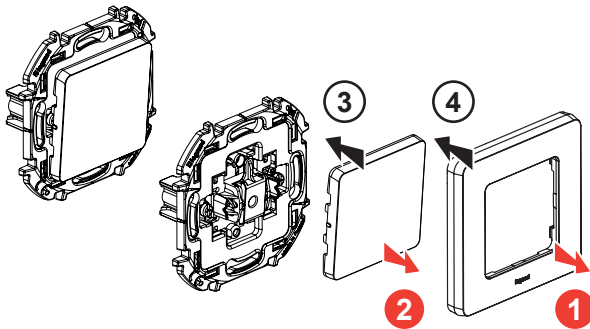

6 736 00/01/02/03



1 OFF

10 AX, 250 B~

≤ 2,5 mm²

13 mm

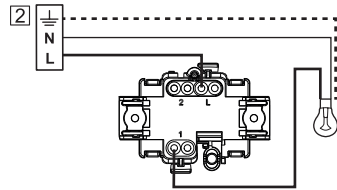

6 736 10/11/12/13

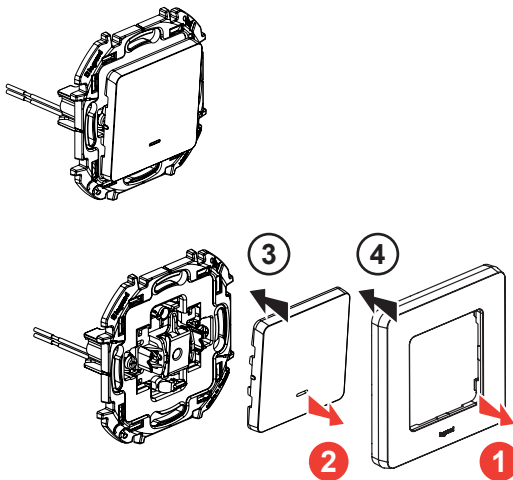

1 OFF

10 AX, 250 B~

≤ 2,5 mm²

13 mm

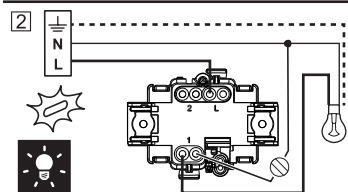
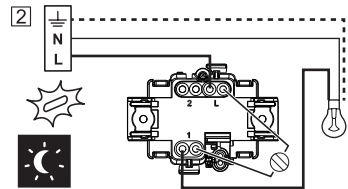

6 736 20/21/22/23

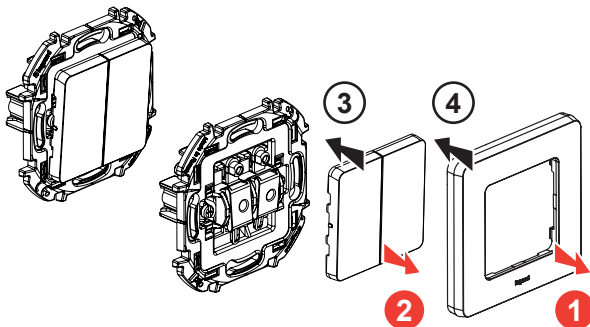

1 OFF

10 AX, 250 B~

≤ 2,5 mm²

13 mm

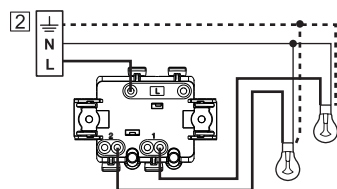

6 736 30/31/32/33

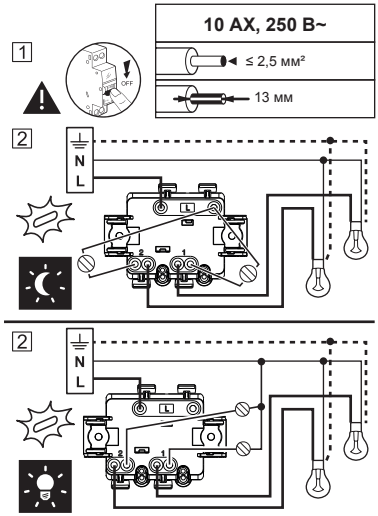
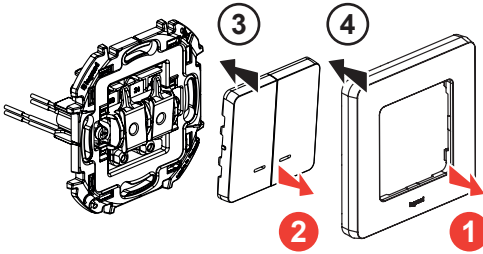
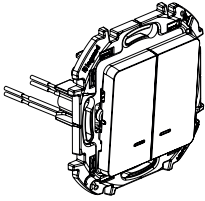

6 736 40/41/42/43

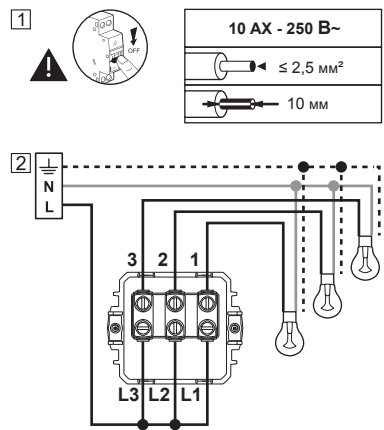
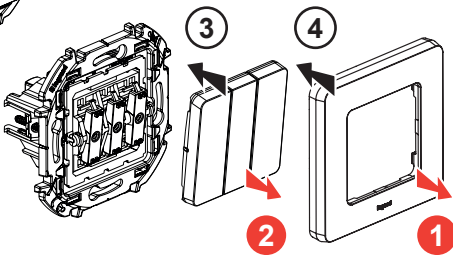
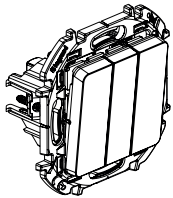

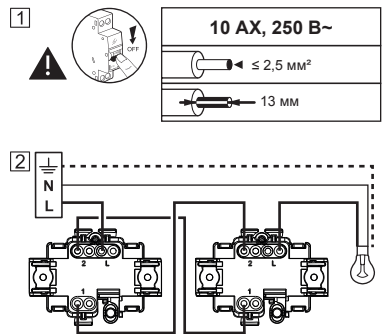
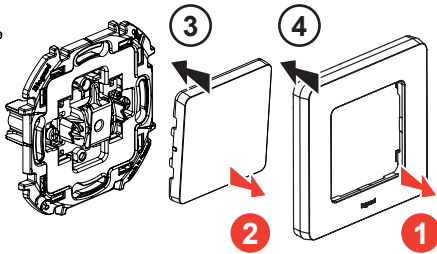
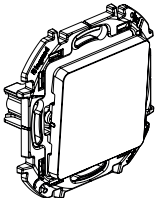

6 736 50/51/52/53

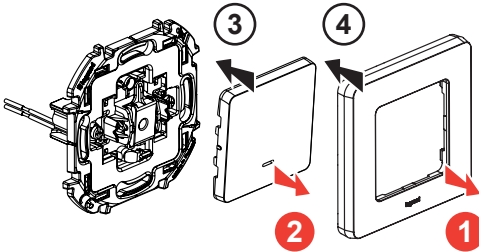
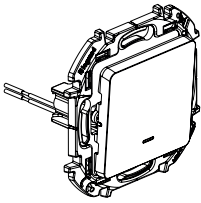

6 736 60/61/62/63

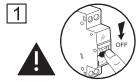



1  **10 AX, 250 B~**

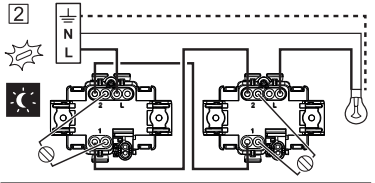

 ≤ 2,5 mm ²
 13 mm

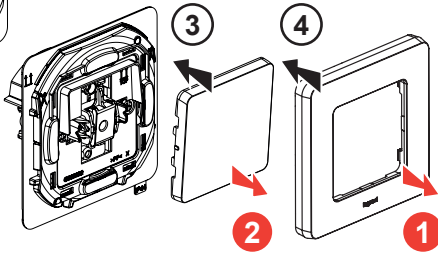
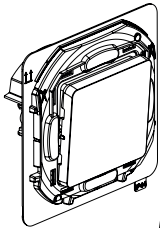

6 736 70/71/72/73



1  **10 AX, 250 B~, IP44**

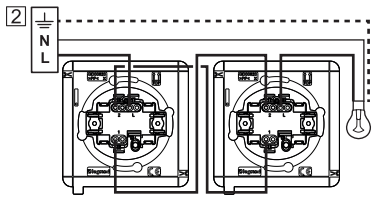

 ≤ 2,5 mm ²
 13 mm

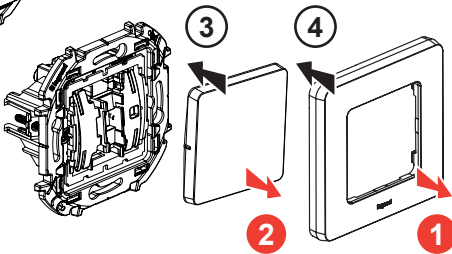
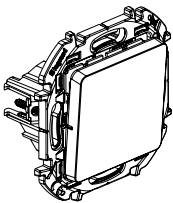

6 736 80/81/82/83

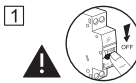

1  **10 AX, 250 B~**

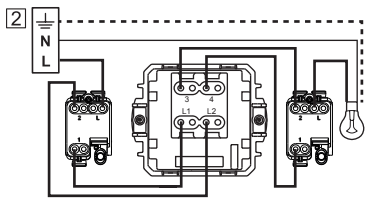

 ≤ 2,5 mm ²
 10 mm



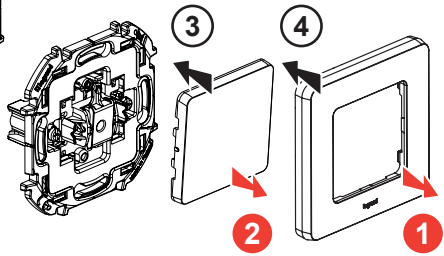
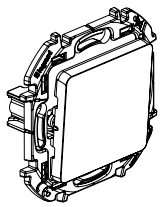

6 736 90/91/92/93



1



6 A, 250 B~
 $\leq 2,5 \text{ mm}^2$
 13 mm

