



FCC Information and Copyright

This equipment has been tested and found to comply with the limits of a Class B digital device, pursuant to Part 15 of the FCC Rules. These limits are designed to provide reasonable protection against harmful interference in a residential installation. This equipment generates, uses, and can radiate radio frequency energy and, if not installed and used in accordance with the instructions, may cause harmful interference to radio communications. There is no guarantee that interference will not occur in a particular installation.

The vendor makes no representations or warranties with respect to the contents here and specially disclaims any implied warranties of merchantability or fitness for any purpose. Further the vendor reserves the right to revise this publication and to make changes to the contents here without obligation to notify any party beforehand.

Duplication of this publication, in part or in whole, is not allowed without first obtaining the vendor's approval in writing.

The content of this user's manual is subject to be changed without notice and we will not be responsible for any mistakes found in this user's manual. All the brand and product names are trademarks of their respective companies.



Dichiarazione di conformità sintetica
Ai sensi dell'art. 2 comma 3 del D.M. 275 del
30/10/2002
Si dichiara che questo prodotto è conforme
alle normative vigenti e soddisfa i requisiti
essenziali richiesti dalle direttive
2004/108/CE, 2006/95/CE e 1999/05/CE
quando ad esso applicabili

Short Declaration of conformity
We declare this product is complying with the
laws in force and meeting all the essential
requirements as specified by the directives
2004/108/CE, 2006/95/CE and 1999/05/CE
whenever these laws may be applied

Table Of Contents

FCC Information and Copyright	1
Chapter 1: Introduction.....	3
1.1 Before You Start	3
1.2 Package Checklist.....	3
1.3 Specifications.....	4
1.4 Rear Panel Connectors.....	5
1.5 Motherboard Layout	6
Chapter 2: Hardware installation.....	7
2.1 Connect Cooling Fans	7
2.2 Install System Memory	7
2.3 Expansion Slots.....	9
2.4 Jumper & Switch Setting.....	10
2.5 Headers & Connectors.....	11
Chapter 3: UEFI BIOS & Software.....	15
3.1 UEFI BIOS Setup	15
3.2 BIOS Update.....	15
3.3 Software.....	19
Chapter 4: Useful help.....	20
4.1 Driver Installation	20
4.2 AMI BIOS Beep Code.....	21
4.3 Troubleshooting.....	21
APPENDIX I: Specifications in Other Languages	23
Arabic.....	23
German.....	24
Russian.....	25
Spanish	26
Thai.....	27

Chapter 1: Introduction

1.1 Before You Start

Thank you for choosing our product. Before you start installing the motherboard, please make sure you follow the instructions below:

- Prepare a dry and stable working environment with sufficient lighting.
- Always disconnect the computer from power outlet before operation.
- Before you take the motherboard out from anti-static bag, ground yourself properly by touching any safely grounded appliance, or use grounded wrist strap to remove the static charge.
- Avoid touching the components on motherboard or the rear side of the board unless necessary. Hold the board on the edge, do not try to bend or flex the board.
- Do not leave any unfastened small parts inside the case after installation. Loose parts will cause short circuits which may damage the equipment.
- Keep the computer from dangerous area, such as heat source, humid air and water.
- The operating temperatures of the computer should be 0 to 45 degrees Celsius.
- To avoid injury, be careful of:
 - Sharp pins on headers and connectors
 - Rough edges and sharp corners on the chassis
 - Damage to wires that could cause a short circuit

1.2 Package Checklist

- Serial ATA Cable x2
- Rear I/O Panel for ATX Case x1
- Quick Installation x1
- Fully Setup Driver DVD x1

Note

- » *The package contents may be different due to the sales region or models in which it was sold. For more information about the standard package in your region, please contact your dealer or sales representative.*
-

1.3 Specifications

Specifications	
CPU	Intel® Celeron® J1800 processor
Memory	Supports Dual Channel DDR3L-1333 (1.35V/1.5V) 2x DDR3L SO-DIMM Memory Slot, Max. Supports up to 16 GB Memory Each DIMM supports non-ECC 512MB/ 1/ 2/ 4/ 8 GB DDR3L module * Please refer to www.biostar.com.tw for Memory support list.
Storage	2x SATA 3Gb/s Connector Supports Native IDE, AHCI Mode
LAN	Realtek RTL8111G 10/ 100/ 1000 Mb/s auto negotiation, Half / Full duplex capability
Audio Codec	ALC662 5.1 Channels, High Definition Audio
USB	6x USB 2.0 port (4 on rear I/Os and 2 via internal header) 1x USB 3.2(Gen1) port (1 on rear I/Os)
Expansion Slots	1x PCIe x1 Slot
Rear I/Os	1x PS/2 Mouse 1x PS/2 Keyboard 1x VGA Port 1x HDMI Port 1x USB 3.2(Gen1) Port 4x USB 2.0 Port 1x LAN port 3x Audio Jack
Internal I/Os	2x SATA 3Gb/s Connector 2x USB 2.0 Header (each header supports 2 USB 2.0 ports) 1x 4-Pin Power Connector 1x 24-Pin Power Connector 2x System Fan Connector 1x Front Panel Header 1x Front Audio Header 1x Clear CMOS Header 1x Printer Port Header 1x Serial Port Header
Form Factor	Mini-ITX Form Factor, 170 mm x 170 mm
OS Support	Windows 7/ 8/ 8.1/ 10(32bit/64bit) Biostar reserves the right to add or remove support for any OS with or without notice.

1.4 Rear Panel Connectors

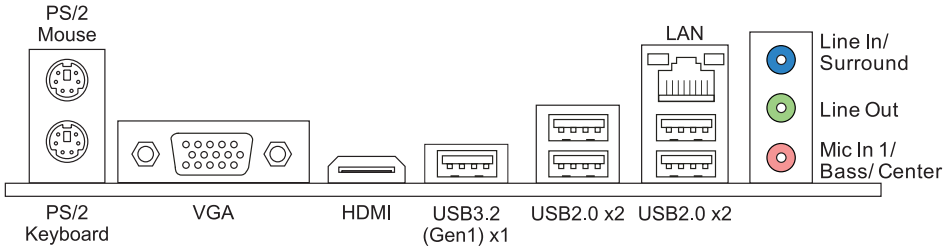

Note

- » HDMI & VGA ports only work with an Intel® integrated Graphics Processor.
- » Maximum resolution
 - HDMI: 1920 x 1200 @60Hz
 - VGA: 2560 x 1600 @60Hz
- » Since the audio chip supports High Definition Audio Specification, the function of each audio jack can be defined by software. The input / output function of each audio jack listed above represents the default setting. However, when connecting external microphone to the audio port, please use the Line In (Blue) and Mic In (Pink) audio jack.

The 2/ 4/ 5.1/ 7.1-channel configuration

Audio Port	2-channel	4-channel	5.1 channel	7.1 channel
Blue (Rear Panel)	Line In	Line In	Line In	Side Speaker Out
Green (Rear Panel)	Line Out	Front Speaker Out	Front Speaker Out	Front Speaker Out
Pink (Rear Panel)	Mic In	Mic In	Center/Subwoofer Out	Center/Subwoofer Out
Green (Front Panel)	Headphone	Rear Speaker Out	Rear Speaker Out	Rear Speaker Out

1.5 Motherboard Layout

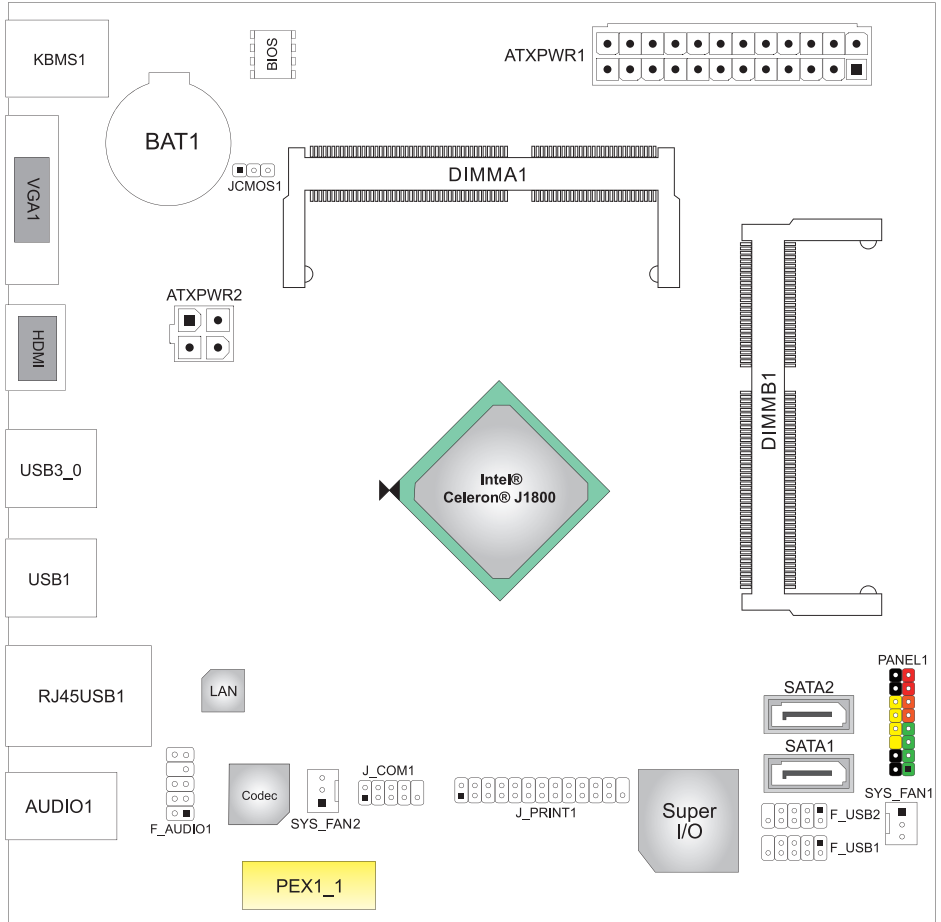

Note

» ■ represents the 1st pin.

Chapter 2: Hardware installation

2.1 Connect Cooling Fans

These fan headers support cooling-fans built in the computer. The fan cable and connector may be different according to the fan manufacturer. Connect the fan cable to the connector while matching the black wire to pin#1.

SYS_FAN1/SYS_FAN2: System Fan Header

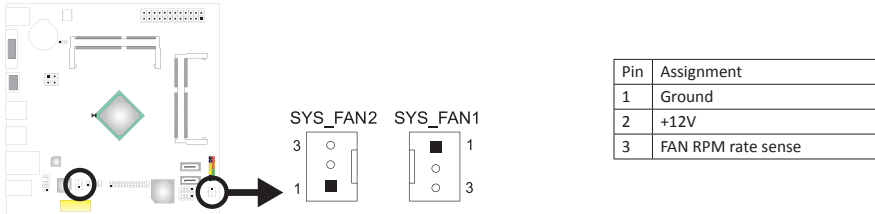

Note

» When connecting with wires onto connectors, please note that the red wire is the positive and should be connected to pin#2, and the black wire is Ground and should be connected to GND.

2.2 Install System Memory

A. DDR3L SO-DIMM Module (1.35V/1.5V)

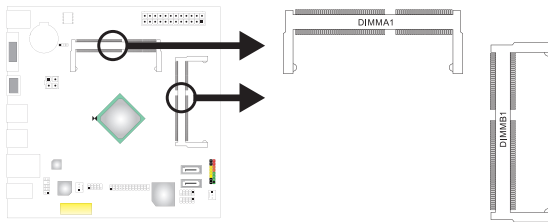

Step 1: Align a DIMM on the slot such that the notch on the DIMM matches the break on the Slot.

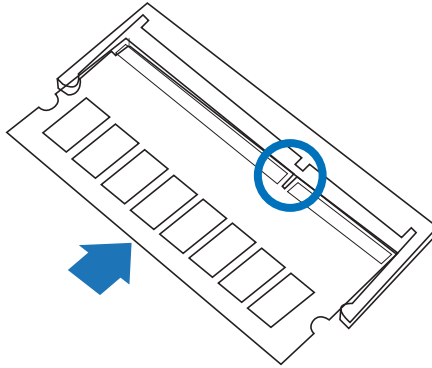

Step 2: Insert the DIMM firmly into the slot until the retaining chip snap back in place and the DIMM is properly seated.

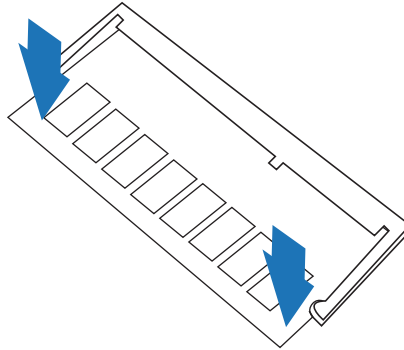

Note

» If the DIMM does not go in smoothly, do not force it. Pull it all the way out and try again.

Memory Capacity

DIMM Socket Location	DDR3L Module	Total Memory Size
DIMMA1	512MB/1GB/2GB/4GB/8GB	Max is 16GB.
DIMMB1	512MB/1GB/2GB/4GB/8GB	

Dual Channel Memory Installation

Please refer to the following requirements to activate Dual Channel function:
Install memory module of the same density in pairs, shown in the table.

Dual Channel Status	DIMMA1	DIMMB1
Disabled	O	X
Enabled	O	O

(O means memory installed, X means memory not installed.)

Note

» When installing more than one memory module, we recommend to use the same brand and capacity memory on this motherboard.

2.3 Expansion Slots

PEX1_1: PCI-Express Gen2 x1 Slot

- PCI-Express 2.0 compliant.
- Data transfer bandwidth up to 500MB/s per direction; 1GB/s in total.

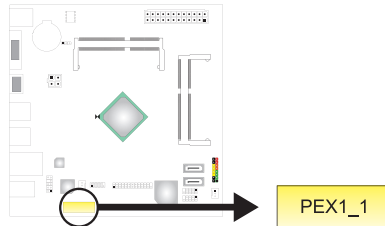

Install an Expansion Card

You can install your expansion card by following steps:

- Read the related expansion card's instruction document before install the expansion card into the computer.
- Remove your computer's chassis cover, screws and slot bracket from the computer.
- Place a card in the expansion slot and press down on the card until it is completely seated in the slot.
- Secure the card's metal bracket to the chassis back panel with a screw.
- Replace your computer's chassis cover.
- Power on the computer, if necessary, change BIOS settings for the expansion card.
- Install related driver for the expansion card.

2.4 Jumper & Switch Setting

The illustration shows how to set up jumpers. When the jumper cap is placed on pins, the jumper is “close”, if not, that means the jumper is “open”.

Pin opened



Pin closed



Pin 1-2 closed



JCMOS1: Clear CMOS Jumper

The jumper allows users to restore the BIOS safe setting and the CMOS data. Please carefully follow the procedures to avoid damaging the motherboard.

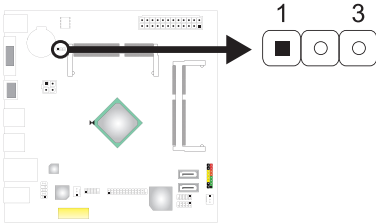

Pin 1-2 Open: Normal Operation (Default)



Pin 1-2 Close: Clear CMOS data

Clear CMOS Procedures:

1. Remove AC power line.
2. Set the jumper to “Pin 2-3 close”.
3. Wait for five seconds.
4. Set the jumper to “Pin 1-2 close”.
5. Power on the AC.
6. Load Optimal Defaults and save settings in CMOS.

2.5 Headers & Connectors

ATXPWR1: ATX Power Source Connector

For better compatibility, we recommend to use a standard ATX 24-pin power supply for this connector. Make sure to find the correct orientation before plugging the connector.

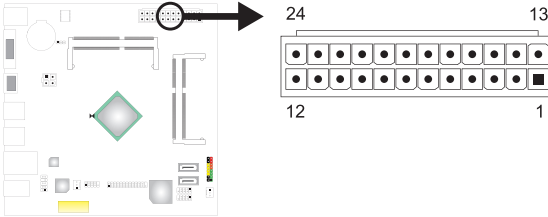

Pin	Assignment	Pin	Assignment
13	+3.3V	1	+3.3V
14	-12V	2	+3.3V
15	Ground	3	Ground
16	PS_ON	4	+5V
17	Ground	5	Ground
18	Ground	6	+5V
19	Ground	7	Ground
20	NC	8	PW_OK
21	+5V	9	Standby Voltage+5V
22	+5V	10	+12V
23	+5V	11	+12V
24	Ground	12	+3.3V

ATXPWR2: ATX Power Source Connector

The connector provides +12V to the CPU power circuit.

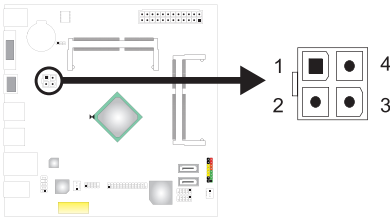

Pin	Assignment
1	+12V
2	+12V
3	Ground
4	Ground

Note

- » Before you power on the system, please make sure that both ATXPWR1 and ATXPWR2 connectors have been plugged-in.
- » Insufficient power supplied to the system may result in instability or the peripherals not functioning properly. Use of a PSU with a higher power output is recommended when configuring a system with more power-consuming devices.

PANEL1: Front Panel Header

This 16-pin header includes Power-on, Reset, HDD LED, Power LED, and speaker connection.

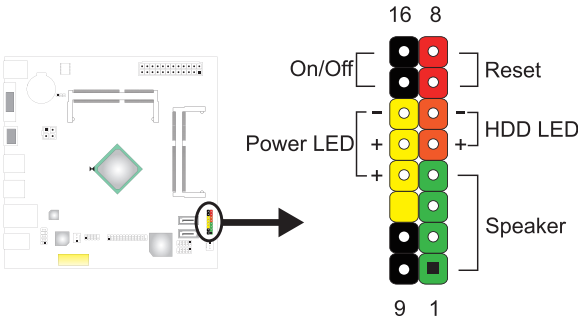

Pin	Assignment	Function	Pin	Assignment	Function
1	+5V	Speaker Connector	9	N/A	N/A
2	N/A		10	N/A	
3	N/A		11	N/A	
4	Speaker	12	Power LED (+)	Power LED	
5	HDD LED (+)	13	Power LED (+)		
6	HDD LED (-)	14	Power LED (-)		
7	Ground	Reset button	15	Power button	Power-on button
8	Reset control		16	Ground	

SATA1/2: Serial ATA 6.0 Gb/s Connectors

These connectors connect to SATA hard disk drives via SATA cables.

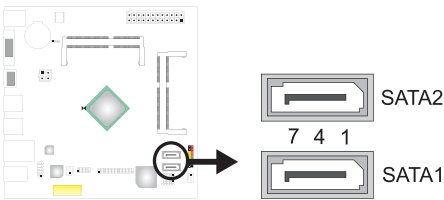

Pin	Assignment
1	Ground
2	TX+
3	TX-
4	Ground
5	RX-
6	RX+
7	Ground

F_USB1/2: Header for USB 2.0 Ports at Front Panel

This header allows user to add additional USB ports on the PC front panel, and also can be connected with a wide range of external peripherals.

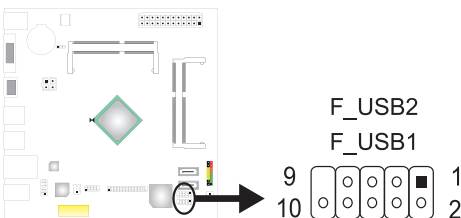

Pin	Assignment
1	+5V (fused)
2	+5V (fused)
3	USB-
4	USB-
5	USB+
6	USB+
7	Ground
8	Ground
9	Key
10	NC

F_AUDIO1: Front Panel Audio Header

This header allows user to connect the chassis-mount front panel audio I/O which supports HD and AC'97 audio standards.

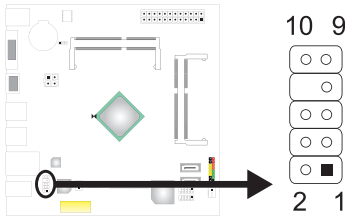

HD Audio		AC'97	
Pin	Assignment	Pin	Assignment
1	Mic Left in	1	Mic In
2	Ground	2	Ground
3	Mic Right in	3	Mic Power
4	GPIO	4	Audio Power
5	Right line in	5	RT Line Out
6	Jack Sense	6	RT Line Out
7	Front Sense	7	Reserved
8	Key	8	Key
9	Left line in	9	LFT Line Out
10	Jack Sense	10	LFT Line Out

Note

- » It is recommended that you connect a high-definition front panel audio module to this connector to avail of the motherboard's high definition audio capability.
- » Please try to disable the "Front Panel Jack Detection" if you want to use an AC'97 front audio output cable. The function can be found via O.S. Audio Utility.

J_PRINT1: Printer Port Connector

This header allows you to connector printer on the PC.

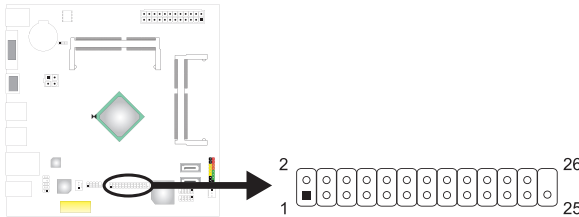

Pin	Assignment	Pin	Assignment
1	-Strobe	14	Ground
2	-ALF	15	Data 6
3	Data 0	16	Ground
4	-Error	17	Data 7
5	Data 1	18	Ground
6	-Init	19	-ACK
7	Data 2	20	Ground
8	-Scltin	21	Busy
9	Data 3	22	Ground
10	Ground	23	PE
11	Data 4	24	Ground
12	Ground	25	SCLT
13	Data 5	26	Key

J_COM1: Serial Port Header

The motherboard has a serial port header for connecting RS-232 Port.

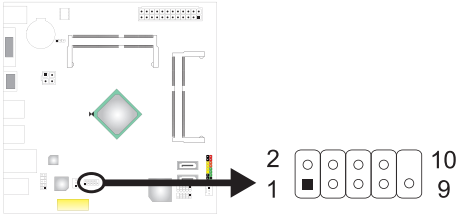

Pin	Assignment
1	Carrier detect
2	Received data
3	Transmitted data
4	Data terminal ready
5	Signal ground
6	Data set ready
7	Request to send
8	Clear to send
9	Ring indicator
10	Key

Chapter 3: UEFI BIOS & Software

3.1 UEFI BIOS Setup

- The BIOS Setup program can be used to view and change the BIOS settings for the computer. The BIOS Setup program is accessed by pressing the key after the Power-On Self-Test (POST) memory test begins and before the operating system boot begins.
- For further information of setting up the UEFI BIOS, please refer to the UEFI BIOS Manual on our website.

3.2 BIOS Update

The BIOS can be updated using either of the following utilities:

- **BIOSTAR BIO-Flasher:** Using this utility, the BIOS can be updated from a file on a hard disk, a USB drive (a flash drive or a USB hard drive), or a CD-ROM.
- **BIOSTAR BIOS Update Utility:** It enables automated updating while in the Windows environment. Using this utility, the BIOS can be updated from a file on a hard disk, a USB drive (a flash drive or a USB hard drive), or a CD-ROM, or from the file location on the Web.

BIOSTAR BIO-Flasher

Note

- » This utility only allows storage device with FAT32/16 format and single partition.
- » Shutting down or resetting the system while updating the BIOS will lead to system boot failure.

Updating BIOS with BIOSTAR BIO-Flasher

1. Go to the website to download the latest BIOS file for the motherboard.
2. Then, copy and save the BIOS file into a USB flash (pen) drive. (Only supported FAT/FAT32 format)
3. Insert the USB pen drive that contains the BIOS file to the USB port.
4. Power on or reset the computer and then press <F12> during the POST process.

5. After entering the POST screen, the BIO-FLASHER utility pops out. Choose <fs0> to search for the BIOS file.

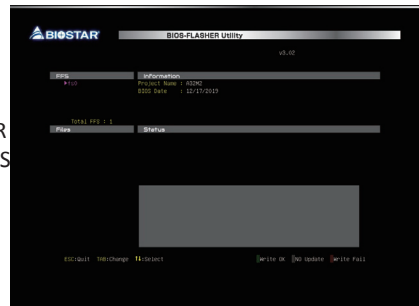

6. Select the proper BIOS file, and a message asking if you are sure to flash the BIOS file. Click “Yes” to start updating BIOS.



7. A dialog pops out after BIOS flash is completed, asking you to restart the system. Press the <Y> key to restart system.

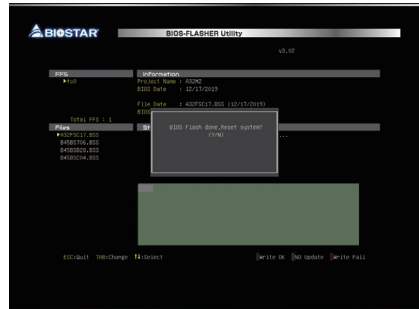

8. While the system boots up and the full screen logo shows up, press key to enter BIOS setup.

After entering the BIOS setup, please go to the <Save & Exit>, using the <Restore Defaults> function to load Optimized Defaults, and select <Save Changes and Reset> to restart the computer. Then the BIOS Update is completed.

BIOS Update Utility (through the Internet)

1. Installing BIOS Update Utility from the DVD Driver.
2. Please make sure the system is connected to the internet before using this function.

3. Launch BIOS Update Utility and click the “Online Update” button on the main screen.



4. An open dialog will show up to request your agreement to start the BIOS update. Click “Yes” to start the online update procedure.

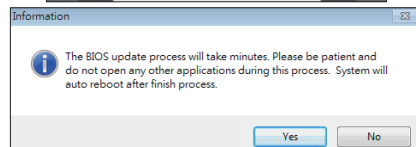

5. If there is a new BIOS version, the utility will ask you to download it. Click “Yes” to proceed.

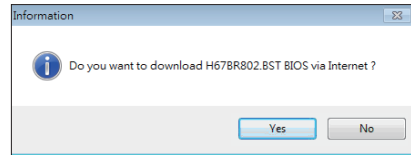

6. After the download is completed, you will be asked to program (update) the BIOS or not. Click “Yes” to proceed.

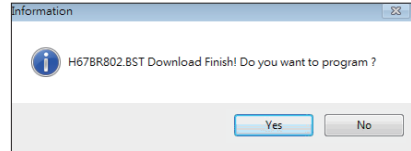

7. After the updating process is finished, you will be asked you to reboot the system. Click “OK” to reboot.

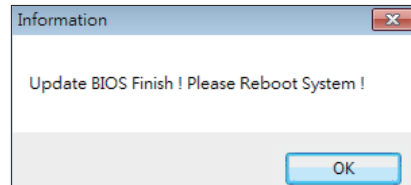

8. While the system boots up and the full screen logo shows up, press key to enter BIOS setup.

After entering the BIOS setup, please go to the <Save & Exit>, using the <Restore Defaults> function to load Optimized Defaults, and select <Save Changes> and <Reset> to restart the computer. Then, the BIOS Update is completed.

BIOS Update Utility (through a BIOS file)

1. Installing BIOS Update Utility from the DVD Driver.
2. Download the proper BIOS from <http://www.biostar.com.tw/>

3. Launch BIOS Update Utility and click the “Update BIOS” button on the main screen.



4. A warning message will show up to request your agreement to start the BIOS update. Click “OK” to start the update procedure.

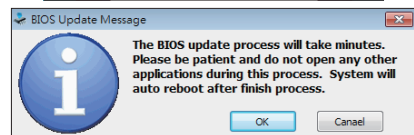

5. Choose the location for your BIOS file in the system. Please select the proper BIOS file, and then click on “Open”. It will take several minutes, please be patient.

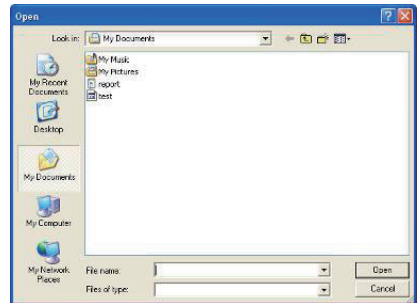

6. After the BIOS Update process is finished, click on “OK” to reboot the system.

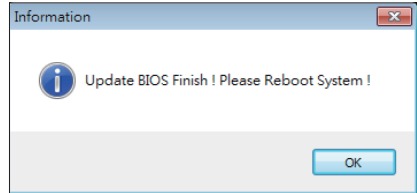

7. While the system boots up and the full screen logo shows up, press key to enter BIOS setup. After entering the BIOS setup, please go to the <Save & Exit>, using the <Restore Defaults> function to load Optimized Defaults, and select <Save Changes and Reset> to restart the computer. Then, the BIOS Update is completed.

Backup BIOS

Click the Backup BIOS button on the main screen for the backup of BIOS, and select a proper location for your backup BIOS file in the system, and click “Save”.

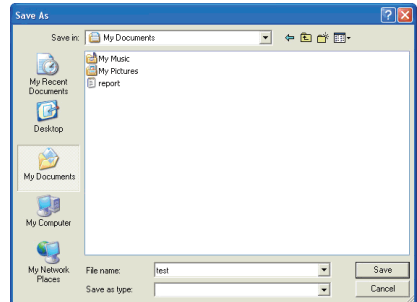

3.3 Software

Installing Software

1. Insert the Setup DVD to the optical drive. The driver installation program would appear if the Auto-run function has been enabled.
2. Select Software Installation, and then click on the respective software title.
3. Follow the on-screen instructions to complete the installation.

Launching Software

After the installation process is completed, you will see the software icon showing on the desktop. Double-click the icon to launch it.

Note

- » All the information and content about following software are subject to be changed without notice. For better performance, the software is being continuously updated.
- » The information and pictures described below are for your reference only. The actual information and settings on board may be slightly different from this manual.

BIOScreen Utility

This utility allows you to personalize your boot logo easily. You can choose BMP as your boot logo so as to customize your computer.



Please follow the step-by-step instructions below to update boot logo:

- Load Image: Choose the picture as the boot logo.
- Transform: Transform the picture for BIOS and preview the result.
- Update Bios: Write the picture to BIOS Memory to complete the update.

Chapter 4: Useful help

4.1 Driver Installation

After you installed your operating system, please insert the Fully Setup Driver DVD into your optical drive and install the driver for better system performance.

You will see the following window after you insert the DVD

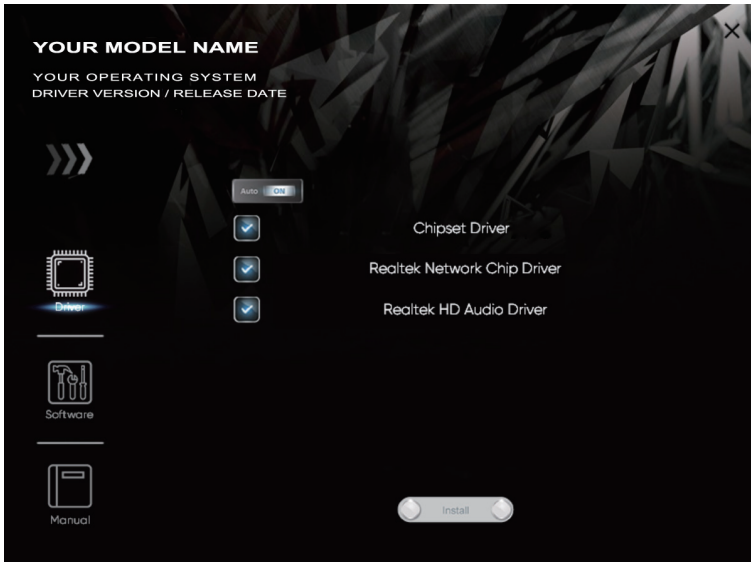

The setup guide will auto detect your motherboard and operating system.

A. Driver Installation

To install the driver, please click on the Driver icon. The setup guide will list the compatible driver for your motherboard and operating system. Click on each device driver to launch the installation program.

B. Software Installation

To install the software, please click on the Software icon. The setup guide will list the software available for your system, click on each software title to launch the installation program.

C. Manual

Aside from the paperback manual, we also provide manual in the Driver DVD. Click on the Manual icon to browse for available manual.

Note

- » *If this window didn't show up after you insert the Driver DVD, please use file browser to locate and execute the file SETUP.EXE under your optical drive.*
- » *You will need Acrobat Reader to open the manual file. Please download the latest version of Acrobat Reader software from <http://get.adobe.com/reader/>*
- » *Intel(R) Trusted Execution Engine Interface Driver is only supported with Windows 8/8.1 & Windows 7. For Windows 7 user, please install Microsoft Kernel-Mode Driver Framework (KMDF) version 1.1. Otherwise, you found a yellow bang appears as "Intel Trusted Execution Engine Interface" under system device manager. Also, you can follow the Microsoft instructions from the link: KB2685811. <http://support.microsoft.com/kb/2685811>*

4.2 AMI BIOS Beep Code

Boot Block Beep Codes

Number of Beeps	Description
Continuing	Memory sizing error or Memory module not found

POST BIOS Beep Codes

Number of Beeps	Description
1	Success booting.
8	Display memory error (system video adapter)

4.3 Troubleshooting

Probable	Solution
1. There is no power in the system. Power LED does not shine; the fan of the power supply does not work. 2. Indicator light on keyboard does not shine.	1. Make sure power cable is securely plugged in. 2. Replace cable. 3. Contact technical support.
System is inoperative. Keyboard lights are on, power indicator lights are lit, and hard drives are running.	Using even pressure on both ends of the DIMM, press down firmly until the module snaps into place.
System does not boot from a hard disk drive, but can be booted from optical drive.	1. Check cable running from disk to disk controller board. Make sure both ends are securely plugged in; check the drive type in the standard CMOS setup. 2. Backing up the hard drive is extremely important. All hard disks are capable of breaking down at any time.
System only boots from an optical drive. Hard disks can be read, applications can be used, but system fails to boot from a hard disk.	1. Back up data and applications files. 2. Reformat the hard drive. Re-install applications and data using backup disks.
Screen message shows "Invalid Configuration" or "CMOS Failure."	Review system's equipment. Make sure correct information is in setup.
System cannot boot after user installs a second hard drive.	1. Set master/slave jumpers correctly. 2. Run SETUP program and select correct drive types. Call the drive manufacturers for compatibility with other drives.

CPU Overheated

If the system shutdown automatically after power on system for seconds, that means the CPU protection function has been activated.

When the CPU is over heated, the motherboard will shutdown automatically to avoid a damage of the CPU, and the system may not power on again.

In this case, please double check:

1. The CPU cooler surface is placed evenly with the CPU surface.
2. CPU fan is rotated normally.
3. CPU fan speed is fulfilling with the CPU speed.

After confirmed, please follow steps below to relief the CPU protection function.

1. Remove the power cord from power supply for seconds.
2. Wait for seconds.
3. Plug in the power cord and boot up the system.

Or you can:

1. Clear the CMOS data. (See “Close CMOS Header: JCMOS1” section)
2. Wait for seconds.
3. Power on the system again.

APPENDIX I: Specifications in Other Languages

Arabic

المواصفات	
Intel® Celeron® J1800 processor	قاعدة وحدة المعالجة المركزية
واحدة قنساء يدعم. DDR3L 1333(1.35V/1.5V) فتحات الذاكرة المزودة SO-DIMM، تتحمل كحد أقصى 16 جيجابايت ذاكرة x2 دي. دي. ار. DDR3L فتحة مزدوجة DIMM تتحمل دون 512 ECC ميجا بايت 8/4/2/1/1 جيجابايت دي. دي. ار. DDR3L * يرجى الرجوع إلى الموقع www.biostar.com.tw لقائمة دعم الذاكرة.	الذاكرة
وصلة x2 ساتا SATA 3 جيجا بايت / الثانية تتحمل رايد الأم AHCI/ IDE	التخزين
Realtek RTL8111G 1000 / 100 / 10 ميجابايت / الثانية ، تحديد تلقائي ، النصف / القدرة القصوى المزودة	شبكة محلية LAN
ALC662 5.1 قنوات عالية النقة	الترميز الصوتي
منافذ x 6 ناقل متسلسل عام USB 2.0 (4 في المداخل والمخارج الخلفية و 2 من خلال الموزع الداخلي) منافذ x 1 ناقل متسلسل عام USB 3.2 (Gen1) (1 في المداخل والمخارج الخلفية)	ناقل متسلسل عام USB
x 1 فتحة منفذ الملحقات الإضافية PCIe 1 x	فتحات التوسع
1 x PS/2 الفأرة 1 x PS/2 لوحة المفاتيح للكمبيوتر فتحة توصيل عدد 1 x منظومة العرض المرئي VGA فتحة توصيل عدد 1 x HDMI وسيط متعدد العالوي الوضوح فتحة توصيل عدد 1 x ناقل متسلسل عام USB 3.2 (Gen1) فتحة توصيل عدد 4 x ناقل متسلسل عام USB 2.0 فتحة لتوصيل عدد 1 x الشبكة المحلية LAN فتحة توصيل عدد 3 x جاك للصوت	المداخل والمخارج الخلفية
وصلة x 2 SATA 3 جيجابايت / الثانية موزع x 2 ناقل متسلسل عام USB 2.0 (كل موزع يتحمل فتحتين ناقل متسلسل عام USB 2.0) وصلة للطاقة 1 x 4 دبابيس وصلة للطاقة 1 x 24 دبوس وصلة x 2 مراوح تبريد المنظومة موزع x 1 اللوحة الأمامية موزع x 1 الصوت الأمامي موزع x 1 سمبوس مباشر موزع x 1 فتحة للطابعة موزع x 1 فتحة تسلسلية	المداخل والمخارج الداخلية
موزع x 2 ناقل متسلسل عام USB 2.0 (كل موزع يتحمل فتحتين ناقل متسلسل عام USB 2.0)	عامل الشكل
عامل شكل مدد التكنولوجيا المتقدمة Mini-ITX، 170 x 170 مم	عامل الشكل
ويندوز إكس ب (Windows 7 / 8 / 8.1 / 10(32bit/64bit) * بيوستار BIOSTAR تحتفظ بحق إضافة أو إزالة الدعم لأي نظام تشغيل مع أو بدون أنظار.	أنظمة التشغيل المدعومة

German

Specifications	
Zentralprozessor	Intel® Celeron® Prozessor J1800
Festplattenspeicher	Unterstützt zweikanaliges DDR3L 1333 (1.35V/1.5V) 2 x DDR3L SO-DIMM-SpeicherSlot, Max. Unterstützung bis zu 16GB-Speicher Jedes DIMM unterstützt nicht-ECC 512MB/ 1/ 2/ 4/ 8 GB DDR3L-Module * Bitte konsultieren Sie www.biostar.com.tw für Speicherunterstützung Liste.
Arbeitsspeicher	2x SATA 3Gb-Verbindung Unterstützt Ureinwohner IDE & AHCI Modus
LAN	Realtek RTL8111G 10/ 100/ 1000 Mb Auto-Negotiation, Halb- / Voll-Duplex-fähig
Audio Codec	ALC662 5.1 Kanäle, HD-Audio
USB	6x USB 2.0-Port (4 hintere I/Os und 2 via interne Header) 1x USB 3.2(Gen1)-Port (1 hintere I/O)
Erweiterungsanschlüsse	1x PCIe x1-Slot
Hintere I/Os	1x PS/2-Maus 1x PS/2-Keyboard 1x VGA-Port 1x HDMI-Port 1x LAN-Port 1x USB 3.2(Gen1)-Port 4x USB 2.0-Port 3x Audio Jack
Interne I/Os	2x SATA 3.0Gb/s-Verbindung 2x USB 2.0-Header (jeder Header unterstützt 2 USB 2.0-Ports) 1x 4-Pin-Stromverbindung 1x 24-Pin-Stromverbindung 2x System-Ventilatorverbindung 1x Header für Frontpanel 1x Header für Frontaudio 1x Header für klares CMOS 1x Header für Druckerport 1x Serieller Port-Header
Formfaktor	Mini-ITX Formfaktor, 170 mm x 170 mm
OS-Unterstützung	Windows 7/ 8/ 8.1/ 10(32bit/64bit) Biostar reserves the right to add or remove support for any OS with or without notice.

Russian

Спецификации	
ЦПУ	Процессор Intel® Celeron® J1800
Память	Поддерживает двухканальный DDR3L 1333 (1.35V/1.5V) 2 гнезда платы памяти DDR3L SO-DIMM, максимальная память до 16 Гб Каждый модуль DIMM поддерживает модуль не-ECC 512 Мб/ 1/ 2/ 4/ 8 Гб DDR3L * Перечень поддержки памяти смотрите на www.biostar.com.tw .
Накопитель	Соединитель 2x SATA 3 Гб/с, Поддерживает родной IDE & AHCI режим
Локальная сеть	Realtek RTL8111G Автогласование 10/ 100/ 1000 Мб/с, работает в полно/полудуплексном режиме
Аудиокодек	ALC662 Каналы 5.1, высококачественное аудио
USB	6 порта USB 2.0 (4 сзади ввода-вывода и 2 через внутренние контакты) 1 порта USB 3.2(Gen1) (1 сзади ввода-вывода)
Гнезда расшир.	1x PCIe x1 гнездо
Задняя плата ввода-вывода	1 мышь PS/2 1 клавиатура PS/2 1 порт VGA 1 порт HDMI 1 порта USB 3.2(Gen1) 4 порта USB 2.0 1 порт локальной сети 3 гнезд для подключения наушников
Внутр. Плата ввода-вывода	Соединитель 2x SATA 3 Гб/с 2 контакта USB 2.0 (каждый контакт поддерживает 2 порта USB 2.0) 1 4-выводный разъем питания 1 24-выводный разъем питания 2 разъема вентилятора системы 1 контакт передней панели 1 контакт передней аудиопанели 1 контакт микросхемы Clear CMOS 1 контакт порта принтера 1 контакт последовательного порта
Конструктив	Форм-фактор Mini-ITX, 170мм x 170 мм
Поддержка ОС	Windows 7/ 8/ 8.1/ 10(32bit/64bit) Biostar оставляет за собой право добавлять или удалять поддержку любой ОС, с уведомлением или без.

Spanish

Especificaciones	
UPC	procesador Intel® Celeron® J1800
Memoria	Soporta DDR3L 1333 Doble Canal (1.35V/1.5V) 2x DDR3L SO-DIMM Ranura de memoria Soporta hasta 16 GB Memoria Cada DIMM soporta un modulo non-ECC 512MB/ 1/ 2/ 4/ 8 GB DDR3L *Por favor consultar con www.biostar.com.tw para la lista de compatibilidad con el memoria.
Almacenamiento de información	Conector 2x SATA 3Gb/s Soporta nativo IDE & AHCI modo
LAN	Realtek RTL 8111G 10/ 100/ 1000 Mb/s auto negociación, capacidad dúplex Mitad/Completo
Códec Audio	ALC662 Canales Audio de Alta Definición 5.1
USB	Ranura 6x USB 2.0 (4 en las entradas/salidas posteriores y 2 por los distribuidores internos) Ranura 1x USB 3.2(Gen1) (1 en las entradas/salidas posteriores)
Ranuras de Extinción	Ranura 1x PCIe x1
Panel trasero de E/S	Ratón 1x PS/2 Teclado 1x PS/2 Ranura 1x VGA Ranura 1x HDMI Ranura 1x USB 3.2(Gen1) Ranura 4x USB 2.0 Ranura 1x LAN Socket audio 3x
Conectores en placa	Conector 2x SATA 3Gb's Distribuidor 2x USB 2.0 (cada distribuidor soporta 2 ranuras USB 2.0) Conector con 4 patillas x1 Conector con 24 patillas x1 Conector Ventilador Sistema x2 Distribuidor Panel Frontal x1 Distribuidor Audio Frontal x1 Distribuidor CMOS Directo x1 Distribuidor Ranura Impresora x1 Distribuidor Ranura Serie x1
Factor de Forma	Factor de Forma Mini-ITX, 170 mm x 170 mm
Soporte OS	Windows 7/ 8/ 8.1/ 10(32bit/64bit) Biostar reserva su derecho de añadir o retirar el soporte para cada OS con o sin notificación.

Thai

คุณสมบัติ	
ซีพียู	โปรเซสเซอร์Intel®Celeron® J1800
หน่วยความจำ	สนับสนุน Dual Channel DDR3L 1333 (1.35V/1.5V) รองรับหน่วยความจำ 2 สล็อต DDR3L SO-DIMM สูงสุดถึง 16 GB ทุก DIMM สนับสนุนโมดูล non-ECC 512MB/ 1/ 2/ 4/ 8 GB DDR3L * เข้าชมได้ที่ www.biostar.com.tw สำหรับรายการหน่วยความจำที่สนับสนุน
สตอเรจ	2x SATA 3Gb/s พอร์ตเชื่อมต่อ สนับสนุน Native IDE, AHCI โหมด
แลน	Realtek RTL 8111G 10/ 100/ 1000 Mb/s การเจรจาอัตโนมัติ, ความสามารถในการพลิกซ์ Half / Full
ออดิโอ โคเดค	ALC662 5.1 Channels, High Definition Audio
ยูเอสบี	6x USB 2.0 พอร์ต (4 พอร์ตด้านหลัง I/O และ 2 พอร์ต ผ่านพอร์ตเชื่อมต่อด้านหลัง) 1x USB 3.2(Gen1) พอร์ต (1 พอร์ตด้านหลัง I/O)
สล็อตขยายเพิ่มเติม	1x PCIe x1 สล็อต
พอร์ต I/O ด้านหลัง	1x PS/2 เมาส์ 1x PS/2 คีย์บอร์ด 1x VGA พอร์ต 1x HDMI พอร์ต 1x USB 3.2(Gen1) พอร์ต 4x USB 2.0 พอร์ต 1x LAN พอร์ต 3x Audio Jack
พอร์ต I/O ด้านใน	2x SATA 3Gb/s พอร์ตเชื่อมต่อ 2x USB 2.0 พอร์ตเชื่อมต่อ (หัวเชื่อมต่อทุกตัวรองรับ 2 พอร์ต USB 2.0) 1x 4-Pin Power พอร์ตเชื่อมต่อ 1x 24-Pin Power พอร์ตเชื่อมต่อ 2x พอร์ตเชื่อมต่อระบบ Fan 1x พอร์ตเชื่อมต่อแผงด้านหน้า 1x พอร์ตเชื่อมต่อออดิโอด้านหน้า 1x พอร์ต Clear CMOS 1x พอร์ตเชื่อมต่อพรีนเตอร์ 1x พอร์ตเชื่อมต่อ Serial Port
รูปแบบจากโรงงาน	Mini-ITX จากโรงงาน, 170 มม. x 170 มม
สนับสนุน OS	Windows 7/ 8/ 8.1/ 10(32bit/64bit) Biostar ขอสงวนสิทธิ์ในการเพิ่มหรือลดการสนับสนุนสำหรับระบบปฏิบัติการ OS ต่างๆ โดยไม่ต้องแจ้งให้ทราบล่วงหน้า

this page intentionally left blank