

# Optimo 19L

FR

NL

DE

EN

ES

IT

PT

RU

KK

UK



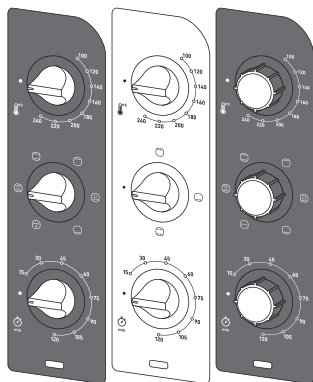
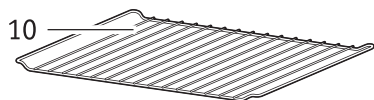
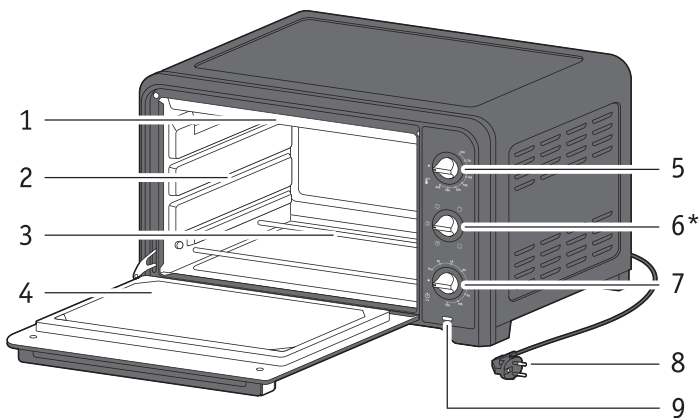

\* selon modèle - afhankelijk van het model - je nach Modell - depending on the model - según el modelo - in base al modello -  
 consoante o modelo - В зависимости от модели - улігіе байланысты - залежно від моделі

## DESCRIPTION

- 1 Résistance supérieure
- 2 Parois en acier à revêtement aluminium
- 3 Résistance inférieure
- 4 Porte double parois
- 5 Bouton de réglage température
- 6 Bouton des fonctions\*
- 7 Bouton de minuterie
- 8 Cordon d'alimentation
- 9 Voyant de fonctionnement
- 10 Grille réversible
- 11 Plat lèche-frite\*

## BESCHRIJVING

- 1 Bovenste verwarmingselement
- 2 Stalen wanden met aluminiumcoating
- 3 Onderste verwarmingselement
- 4 Dubbelwandige deur
- 5 Regelbare thermostaatknop
- 6 Functieknop\*
- 7 Timerknop
- 8 Snoer
- 9 Aan/uit-controlelampje
- 10 Omkeerbaar grillrooster
- 11 Ovenschaal\*

## BESCHREIBUNG

- 1 Oberes Heizelement
- 2 Aluminiumbeschichtete Stahlwände
- 3 Unteres Heizelement
- 4 Doppelwandige Tür
- 5 Temperaturregler
- 6 Funktionsknopf\*
- 7 Timer-Knopf
- 8 Netzkabel
- 9 Betriebskontrollleuchte
- 10 Umkehrbarer Grillrost
- 11 Backblech\*

## DESCRIPTION

- 1 Top heating element
- 2 Aluminium coated steel walls
- 3 Bottom heating element
- 4 Double-wall door
- 5 Temperature control button
- 6 Functions button\*
- 7 Timer button
- 8 Power cord
- 9 Power indicator light
- 10 Reversible grill rack
- 11 Food tray\*

## DESCRIPCIÓN

- 1 Resistencia superior
- 2 Paredes de acero inoxidable con recubrimiento de aluminio
- 3 Resistencia inferior
- 4 Puerta de doble cristal
- 5 Botón de ajuste de temperatura
- 6 Botón de funciones\*
- 7 Botón de temporizador
- 8 Cable de alimentación
- 9 Indicador de funcionamiento
- 10 Parrilla de grill reversible
- 11 Bandeja de comida\*

\* selon modèle - afhankelijk van het model - je nach Modell - depending on the model - según el modelo - in base al modello - consoante o modelo - В зависимости от модели - үлгіге байланысты - залежно від моделі

## DESCRIZIONE

- 1 Elemento riscaldante superiore
- 2 Pareti in acciaio con rivestimento in alluminio
- 3 Elemento riscaldante inferiore
- 4 Porta a doppia parete
- 5 Pulsante di regolazione della temperatura
- 6 Pulsante funzioni\*
- 7 Pulsante timer
- 8 Cavo di alimentazione
- 9 Spia di alimentazione
- 10 Griglia di cottura reversibile
- 11 Vassoio degli alimenti\*

## DESCRIÇÃO

- 1 Resistência superior
- 2 Paredes de aço revestidas a alumínio
- 3 Resistência inferior
- 4 Porta de parede dupla
- 5 Botão de regulação da temperatura
- 6 Botão das funções\*
- 7 Botão temporizador
- 8 Cabo de alimentação
- 9 Luz piloto de funcionamento
- 10 Grelha reversível
- 11 Tabuleiro\*

## ОПИСАНИЕ

- 1 Верхний нагревательный элемент
- 2 Стальные стенки с алюминиевым покрытием
- 3 Нижний нагревательный элемент
- 4 Двухслойная дверца
- 5 Кнопка контроля температуры
- 6 Кнопка выбора функций\*
- 7 Кнопка таймера
- 8 Кабель питания
- 9 Индикатор питания
- 10 Двухсторонняя решетка для гриля
- 11 Противень\*

## СИПАТТАМА

- 1 Жоғарғы қыздыру элементі
- 2 Алюминиймен қапталған болат қабырғалар
- 3 Төменгі қыздыру элементі
- 4 Қос қабырғалы есік
- 5 Температураны басқару түймесі
- 6 Функциялар түймесі\*
- 7 Таймер түймесі
- 8 Қуат сымы
- 9 Қуат индикаторының шамы
- 10 Аударуға болатын гриль сәресі
- 11 Тамақ науасы\*

## ОПИС

- 1 Верхній нагрівальний елемент
- 2 Сталеві стінки з алюмінієвим покриттям
- 3 Нижній нагрівальний елемент
- 4 Дверцята з подвійними стінками
- 5 Кнопка регулювання температури
- 6 Кнопка вибору функцій\*
- 7 Кнопка таймера
- 8 Шнур живлення
- 9 Світловий індикатор живлення
- 10 Двостороння решітка для гриля
- 11 Піднос\*

\* selon modèle - afhankelijk van het model - je nach Modell - depending on the model - según el modelo - in base al modello - consoante o modelo - В зависимости от модели - үлгіге байланысты - залежно від моделі

1

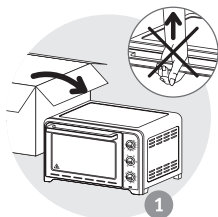

1

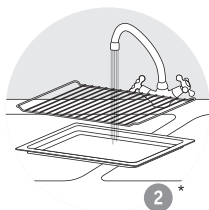

2\*

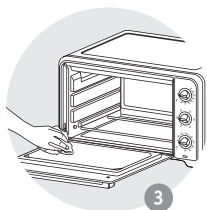

3

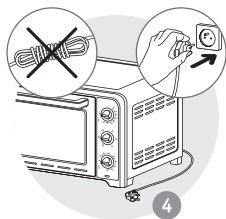

4

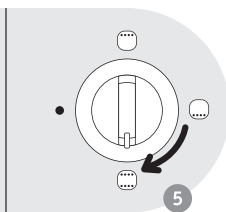
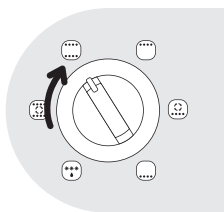

5

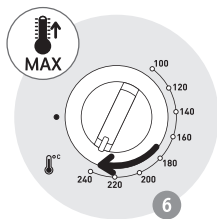

6

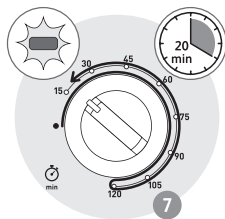

7

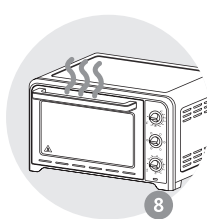

8

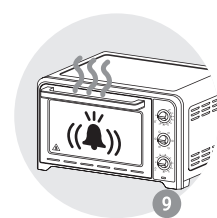

9

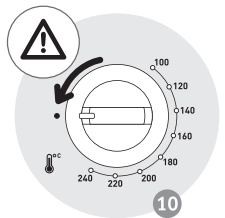

10

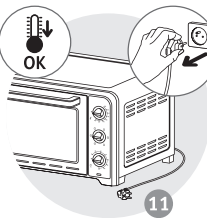

11

\* selon modèle - afhankelijk van het model - je nach Modell - depending on the model - según el modelo - in base al modello -  
 consoante o modelo - В зависимости от модели - улігіе байланысты - залежно від моделі

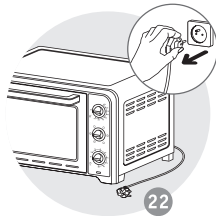
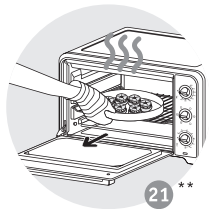
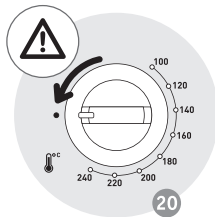
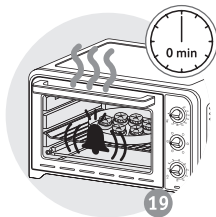
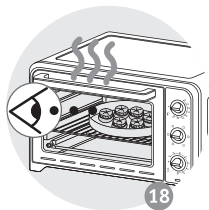
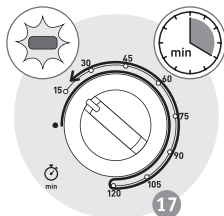
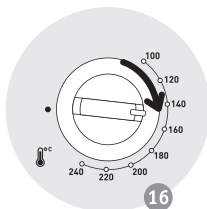
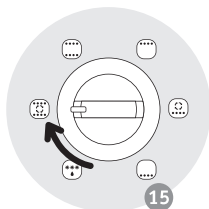
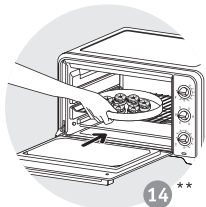
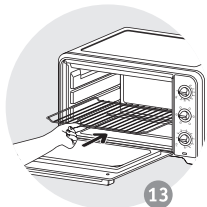
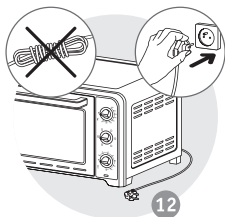

\* selon modèle  
afhankelijk van het model  
je nach Modell  
depending on the model  
según el modelo  
in base al modello  
consoante o modelo  
В зависимости от модели  
үлгіге байланысты  
залежно від моделі

\*\* Plat non fourni avec l'appareil - Schaal niet bij het apparaat inbegrepen - Platte nicht im Lieferumfang inbegriffen - The dish is not supplied with the appliance - El plato no es suministrado con el aparato - Piatto non fornito con l'apparecchio - Travessa não fornecida com o aparelho - Блюдо не входит в комплект - Құрылғымен бірге тәрелке қамтамасыз етілмейді - Блюдо не входит в комплект поставки прибора

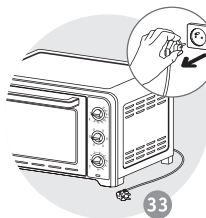
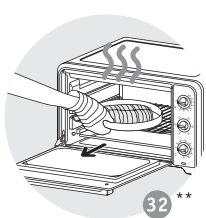
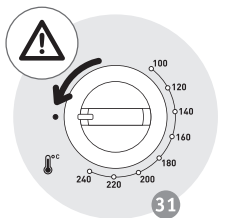
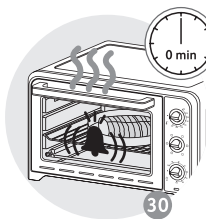
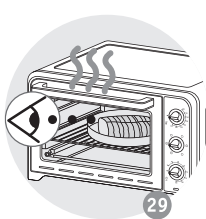
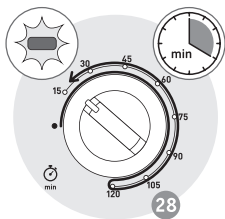
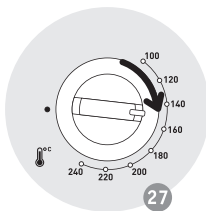
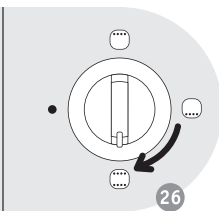
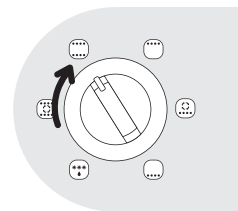
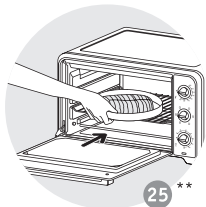
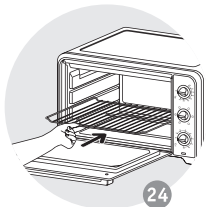
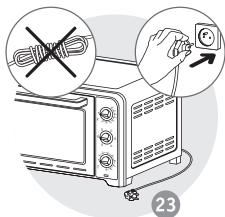

\*\* Plat non furni avec l'appareil - Schaal niet bij het apparaat inbegrepen - Platte nicht im Lieferumfang inbegriffen - The dish is not supplied with the appliance - El plato no es suministrado con el aparato - Piatto non fornito con l'apparecchio - Travessa não fornecida com o aparelho - Блюдо не входит в комплект - Құрылғымен бірге тәрелке қамтамасыз етілмейді - Блюдо не входит в комплект поставки приладу

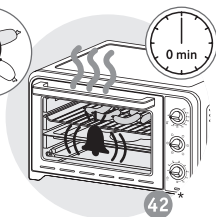
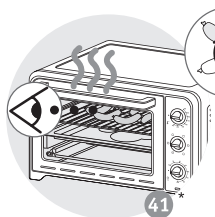
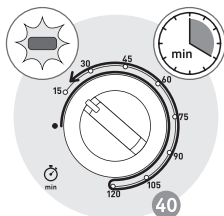
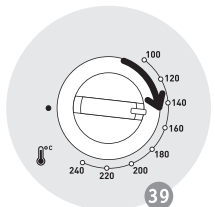
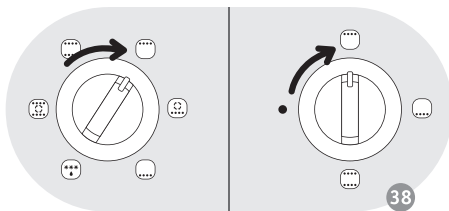
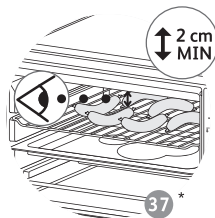
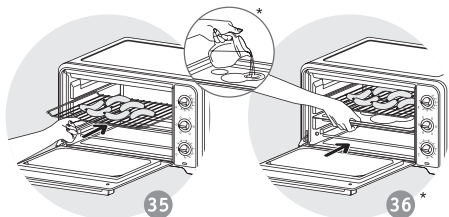
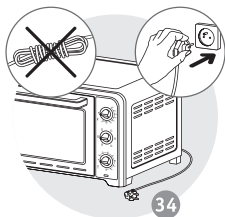

\* selon modèle - afhankelijk van het model - je nach Modell - depending on the model - según el modelo - in base al modello -  
 consoante o modelo - В зависимости от модели - улігіе байланысты - залежно від моделі



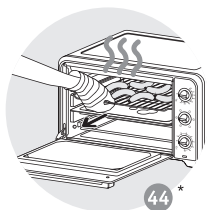
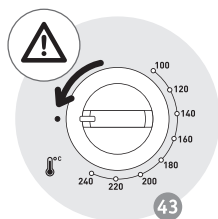

\* selon modèle - afhankelijk van het model - je nach Modell - depending on the model - según el modelo - in base al modello -  
consoante o modelo - В зависимости от модели - үлгіге байланысты - залежно від моделі

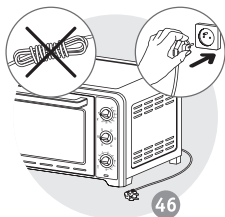

46

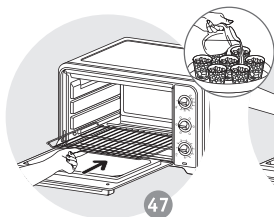

47

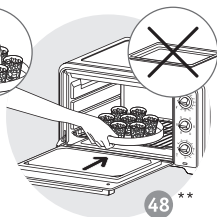

48 \*\*

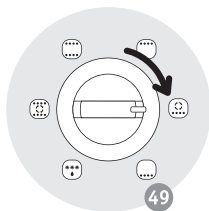

49

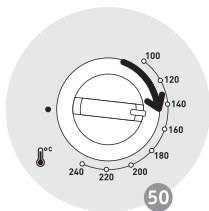

50

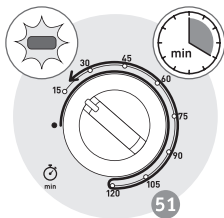

51

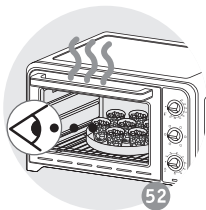

52

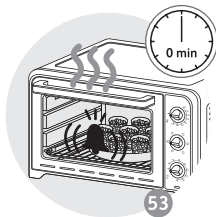

53

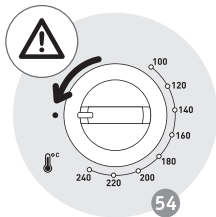

54

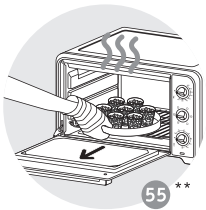

55 \*\*

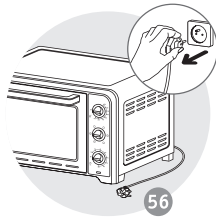

56

\* selon modèle  
afhankelijk van het model  
depending on the model  
según el modelo  
in base al modello  
consoante o modelo  
В зависимости от модели  
үлгіге байланысты  
залежно від моделі

\*\* Plat non fourni avec l'appareil - Schaal niet bij het apparaat inbegrepen - Platte nicht im Lieferumfang inbegriffen - The dish is not supplied with the appliance - El plato no es suministrado con el aparato - Piatto non fornito con l'apparecchio - Travessa não fornecida com o aparelho - Блюдо не входит в комплект - Құрылғымен бірге тәрелке қамтамасыз етілмейді - Блюдо не входит в комплект поставки прилада

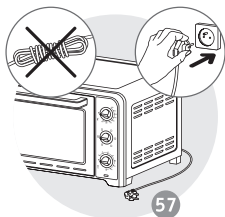

57

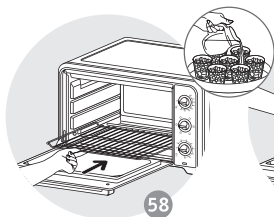

58

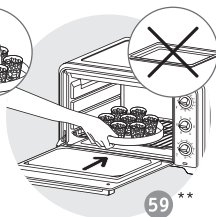

59 \*\*

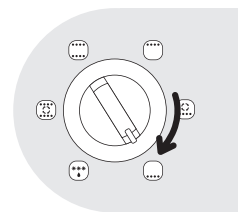

60

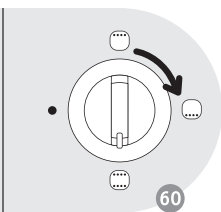

61

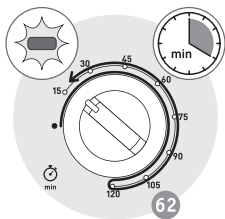
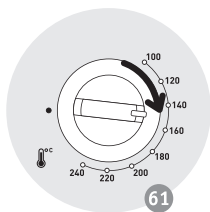

62

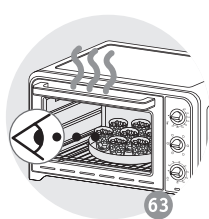

63

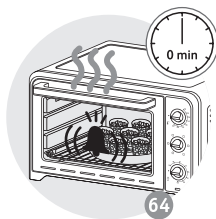

64

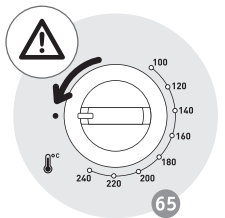

65

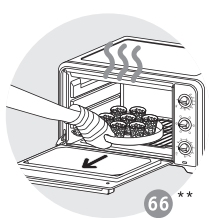

66 \*\*

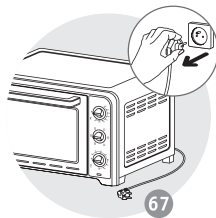

67

\*\* Plat non fourni avec l'appareil - Schaal niet bij het apparaat inbegrepen - Platte nicht im Lieferumfang inbegriffen - The dish is not supplied with the appliance - El plato no es suministrado con el aparato - Piatto non fornito con l'apparecchio - Travessa não fornecida com o aparelho - Блюдо не входит в комплект - Құрылғымен бірге тәрелке қамтамасыз етілмейді - Блюдо не входит в комплект поставки прибора

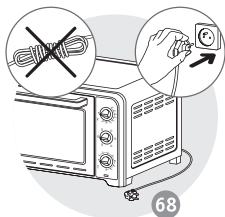

68

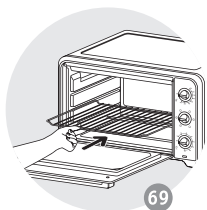

69

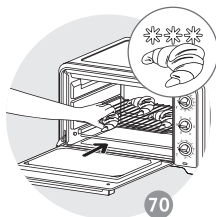

70

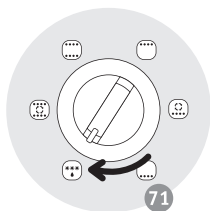

71

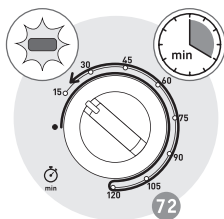

72

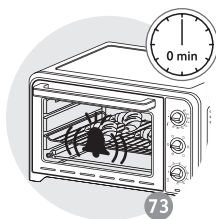

73

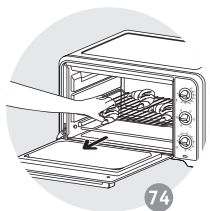

74

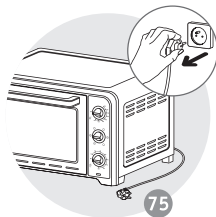

75

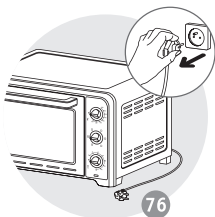

76

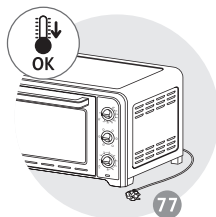

77

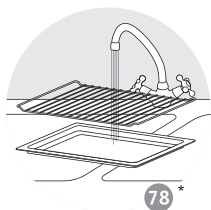

78\*

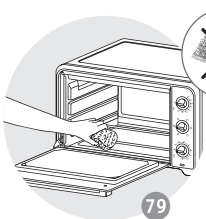

79

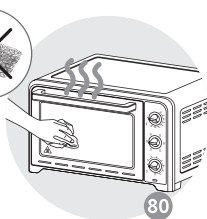

80

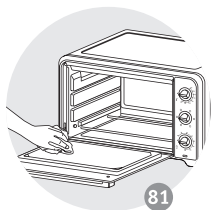

81

\* selon modèle - afhankelijk van het model - je nach Modell - depending on the model - según el modelo - in base al modello -  
 consoante o modelo - В зависимости от модели - улігіце байланысты - залежно від моделі



	x4			10mins	240	20
	870g			10mins	230	65
	750g			10mins	240	42
	500g			-	240	50
	1000g			-	240	80
	x4			-	240	22 
	x8			-	240	15 
	350g			10mins	210	12
	350g			10mins	210	11
				10mins	240	40
	350g			10mins	240	16
				-	240	31
				10mins	200	40

\* selon modèle - afhankelijk van het model - je nach Modell - depending on the model - según el modelo - in base al modello -  
consoante o modelo - В зависимости от модели - улігіе байланысты - залежно від моделі

				10mins	200	18
				10mins	200	40
	x6			10mins	200	10
	x6			10mins	200	16
				10mins	240	55
				10mins	240	25

\* selon modèle - afhankelijk van het model - je nach Modell - depending on the model - según el modelo - in base al modello -  
 consoante o modelo - В зависимости от модели - үлгіге байланысты - залежно від моделі

