

**ASRock**

**B560M  
STEEL LEGEND**



**STEEL LEGEND**

User Manual

Version 1.0

Published January 2021

Copyright©2021 ASRock INC. All rights reserved.

## Copyright Notice:

No part of this documentation may be reproduced, transcribed, transmitted, or translated in any language, in any form or by any means, except duplication of documentation by the purchaser for backup purpose, without written consent of ASRock Inc.

Products and corporate names appearing in this documentation may or may not be registered trademarks or copyrights of their respective companies, and are used only for identification or explanation and to the owners' benefit, without intent to infringe.

## Disclaimer:

Specifications and information contained in this documentation are furnished for informational use only and subject to change without notice, and should not be constructed as a commitment by ASRock. ASRock assumes no responsibility for any errors or omissions that may appear in this documentation.

With respect to the contents of this documentation, ASRock does not provide warranty of any kind, either expressed or implied, including but not limited to the implied warranties or conditions of merchantability or fitness for a particular purpose.

In no event shall ASRock, its directors, officers, employees, or agents be liable for any indirect, special, incidental, or consequential damages (including damages for loss of profits, loss of business, loss of data, interruption of business and the like), even if ASRock has been advised of the possibility of such damages arising from any defect or error in the documentation or product.



This device complies with Part 15 of the FCC Rules. Operation is subject to the following two conditions:

- (1) this device may not cause harmful interference, and
- (2) this device must accept any interference received, including interference that may cause undesired operation.

## CALIFORNIA, USA ONLY

The Lithium battery adopted on this motherboard contains Perchlorate, a toxic substance controlled in Perchlorate Best Management Practices (BMP) regulations passed by the California Legislature. When you discard the Lithium battery in California, USA, please follow the related regulations in advance.

“Perchlorate Material-special handling may apply, see [www.dtsc.ca.gov/hazardouswaste/perchlorate](http://www.dtsc.ca.gov/hazardouswaste/perchlorate)”

**ASRock Website: <http://www.asrock.com>**

## AUSTRALIA ONLY

Our goods come with guarantees that cannot be excluded under the Australian Consumer Law. You are entitled to a replacement or refund for a major failure and compensation for any other reasonably foreseeable loss or damage caused by our goods. You are also entitled to have the goods repaired or replaced if the goods fail to be of acceptable quality and the failure does not amount to a major failure. If you require assistance please call ASRock Tel : +886-2-28965588 ext.123 (Standard International call charges apply)

The terms HDMI® and HDMI High-Definition Multimedia Interface, and the HDMI logo are trademarks or registered trademarks of HDMI Licensing LLC in the United States and other countries.



### INTEL END USER SOFTWARE LICENSE AGREEMENT IMPORTANT - READ BEFORE COPYING, INSTALLING OR USING.

LICENSE. Licensee has a license under Intel's copyrights to reproduce Intel's Software only in its unmodified and binary form, (with the accompanying documentation, the "Software") for Licensee's personal use only, and not commercial use, in connection with Intel-based products for which the Software has been provided, subject to the following conditions:

- (a) Licensee may not disclose, distribute or transfer any part of the Software, and You agree to prevent unauthorized copying of the Software.
- (b) Licensee may not reverse engineer, decompile, or disassemble the Software.
- (c) Licensee may not sublicense the Software.
- (d) The Software may contain the software and other intellectual property of third party suppliers, some of which may be identified in, and licensed in accordance with, an enclosed license.txt file or other text or file.
- (e) Intel has no obligation to provide any support, technical assistance or updates for the Software.

OWNERSHIP OF SOFTWARE AND COPYRIGHTS. Title to all copies of the Software remains with Intel or its licensors or suppliers. The Software is copyrighted and protected by the laws of the United States and other countries, and international treaty provisions. Licensee may not remove any copyright notices from the Software. Except as otherwise expressly provided above, Intel grants no express or implied right under Intel patents, copyrights, trademarks, or other intellectual property rights. Transfer of the license terminates Licensee's right to use the Software.

DISCLAIMER OF WARRANTY. The Software is provided "AS IS" without warranty of any kind, EITHER EXPRESS OR IMPLIED, INCLUDING WITHOUT LIMITATION, WARRANTIES OF MERCHANTABILITY OR FITNESS FOR ANY PARTICULAR PURPOSE.

LIMITATION OF LIABILITY. NEITHER INTEL NOR ITS LICENSORS OR SUPPLIERS WILL BE LIABLE FOR ANY LOSS OF PROFITS, LOSS OF USE, INTERRUPTION OF BUSINESS, OR INDIRECT, SPECIAL, INCIDENTAL, OR CONSEQUENTIAL DAMAGES.

ES OF ANY KIND WHETHER UNDER THIS AGREEMENT OR OTHERWISE, EVEN IF INTEL HAS BEEN ADVISED OF THE POSSIBILITY OF SUCH DAMAGES.

**LICENSE TO USE COMMENTS AND SUGGESTIONS.** This Agreement does NOT obligate Licensee to provide Intel with comments or suggestions regarding the Software. However, if Licensee provides Intel with comments or suggestions for the modification, correction, improvement or enhancement of (a) the Software or (b) Intel products or processes that work with the Software, Licensee grants to Intel a non-exclusive, worldwide, perpetual, irrevocable, transferable, royalty-free license, with the right to sublicense, under Licensee's intellectual property rights, to incorporate or otherwise utilize those comments and suggestions.

**TERMINATION OF THIS LICENSE.** Intel or the sublicensor may terminate this license at any time if Licensee is in breach of any of its terms or conditions. Upon termination, Licensee will immediately destroy or return to Intel all copies of the Software.

**THIRD PARTY BENEFICIARY.** Intel is an intended beneficiary of the End User License Agreement and has the right to enforce all of its terms.

**U.S. GOVERNMENT RESTRICTED RIGHTS.** The Software is a commercial item (as defined in 48 C.F.R. 2.101) consisting of commercial computer software and commercial computer software documentation (as those terms are used in 48 C.F.R. 12.212), consistent with 48 C.F.R. 12.212 and 48 C.F.R. 227.7202-1 through 227.7202-4. You will not provide the Software to the U.S. Government. Contractor or Manufacturer is Intel Corporation, 2200 Mission College Blvd., Santa Clara, CA 95054.

**EXPORT LAWS.** Licensee agrees that neither Licensee nor Licensee's subsidiaries will export/re-export the Software, directly or indirectly, to any country for which the U.S. Department of Commerce or any other agency or department of the U.S. Government or the foreign government from where it is shipping requires an export license, or other governmental approval, without first obtaining any such required license or approval. In the event the Software is exported from the U.S.A. or re-exported from a foreign destination by Licensee, Licensee will ensure that the distribution and export/re-export or import of the Software complies with all laws, regulations, orders, or other restrictions of the U.S. Export Administration Regulations and the appropriate foreign government.

**APPLICABLE LAWS.** This Agreement and any dispute arising out of or relating to it will be governed by the laws of the U.S.A. and Delaware, without regard to conflict of laws principles. The Parties to this Agreement exclude the application of the United Nations Convention on Contracts for the International Sale of Goods (1980). The state and federal courts sitting in Delaware, U.S.A. will have exclusive jurisdiction over any dispute arising out of or relating to this Agreement. The Parties consent to personal jurisdiction and venue in those courts. A Party that obtains a judgment against the other Party in the courts identified in this section may enforce that judgment in any court that has jurisdiction over the Parties.

Licensee's specific rights may vary from country to country.

# Contents

<b>Chapter 1 Introduction</b>	<b>1</b>
1.1 Package Contents	1
1.2 Specifications	2
1.3 Motherboard Layout	7
1.4 I/O Panel	9
<b>Chapter 2 Installation</b>	<b>11</b>
2.1 Installing the CPU	12
2.2 Installing the CPU Fan and Heatsink	15
2.3 Installing Memory Modules (DIMM)	16
2.4 Expansion Slots (PCI Express Slots)	18
2.5 Jumpers Setup	19
2.6 Onboard Headers and Connectors	20
2.7 Post Status Checker	25
2.8 M.2 WiFi/BT Module and Intel® CNVi (Integrated WiFi/BT) Installation Guide	26
2.9 M.2_SSD (NGFF) Module Installation Guide (M2_1)	28
2.10 M.2_SSD (NGFF) Module Installation Guide (M2_2)	32
<b>Chapter 3 Software and Utilities Operation</b>	<b>36</b>
3.1 Installing Drivers	36
3.2 ASRock Motherboard Utility (A-Tuning)	37
3.2.1 Installing ASRock Motherboard Utility (A-Tuning)	37
3.2.2 Using ASRock Motherboard Utility (A-Tuning)	37

3.3	ASRock Live Update & APP Shop	40
3.3.1	UI Overview	40
3.3.2	Apps	41
3.3.3	BIOS & Drivers	44
3.3.4	Setting	45
3.4	Nahimic Audio	46
3.5	ASRock Polychrome SYNC	47

**Chapter 4 UEFI SETUP UTILITY 50**

4.1	Introduction	50
4.2	EZ Mode	51
4.3	Advanced Mode	52
4.3.1	UEFI Menu Bar	52
4.3.2	Navigation Keys	53
4.4	Main Screen	54
4.5	OC Tweaker Screen	55
4.6	Advanced Screen	67
4.6.1	CPU Configuration	68
4.6.2	Chipset Configuration	70
4.6.3	Storage Configuration	73
4.6.4	Super IO Configuration	74
4.6.5	ACPI Configuration	75
4.6.6	USB Configuration	76
4.6.7	Trusted Computing	77
4.7	Tools	78

4.8	Hardware Health Event Monitoring Screen	80
4.9	Security Screen	83
4.10	Boot Screen	84
4.11	Exit Screen	87

# Chapter 1 Introduction

Thank you for purchasing ASRock B560M Steel Legend motherboard, a reliable motherboard produced under ASRock's consistently stringent quality control. It delivers excellent performance with robust design conforming to ASRock's commitment to quality and endurance.

In this documentation, Chapter 1 and 2 contains the introduction of the motherboard and step-by-step installation guides. Chapter 3 contains the operation guide of the software and utilities. Chapter 4 contains the configuration guide of the BIOS setup.



*Because the motherboard specifications and the BIOS software might be updated, the content of this documentation will be subject to change without notice. In case any modifications of this documentation occur, the updated version will be available on ASRock's website without further notice. If you require technical support related to this motherboard, please visit our website for specific information about the model you are using. You may find the latest VGA cards and CPU support list on ASRock's website as well. ASRock website <http://www.asrock.com>.*

## 1.1 Package Contents

- ASRock B560M Steel Legend Motherboard (Micro ATX Form Factor)
- ASRock B560M Steel Legend Quick Installation Guide
- ASRock B560M Steel Legend Support CD
- 2 x Serial ATA (SATA) Data Cables (Optional)
- 1 x I/O Panel Shield
- 3 x Screws for M.2 Sockets (Optional)
- 1 x Standoff for M.2 Socket (Optional)



## 1.2 Specifications

- Platform**
- Micro ATX Form Factor

- CPU**
- Supports 10<sup>th</sup> Gen Intel® Core™ Processors and 11<sup>th</sup> Gen Intel® Core™ Processors (LGA1200)
  - Digi Power design
  - 10 Power Phase design
  - Supports Intel® Turbo Boost Max 3.0 Technology

- Chipset**
- Intel® B560

- Memory**
- Dual Channel DDR4 Memory Technology
  - 4 x DDR4 DIMM Slots
  - 11<sup>th</sup> Gen Intel® Core™ Processors support DDR4 non-ECC, un-buffered memory up to 4800+(OC)\*
  - 10<sup>th</sup> Gen Intel® Core™ Processors support DDR4 non-ECC, un-buffered memory up to 4666+(OC)\*
  - \* 11<sup>th</sup> Gen Intel® Core™ (i9/i7/i5) support DDR4 up to 3200; Core™ (i3), Pentium® and Celeron® support DDR4 up to 2666.
  - \* 10<sup>th</sup> Gen Intel® Core™ (i9/i7) support DDR4 up to 2933; Core™ (i5/i3), Pentium® and Celeron® support DDR4 up to 2666.
  - \* Please refer to Memory Support List on ASRock's website for more information. (<http://www.asrock.com/>)
  - Supports ECC UDIMM memory modules (operate in non-ECC mode)
  - Max. capacity of system memory: 128GB
  - Supports Intel® Extreme Memory Profile (XMP) 2.0
  - 15µ Gold Contact in DIMM Slots

**Expansion Slot**      **11<sup>th</sup> Gen Intel® Core™ Processors**

- 1 x PCI Express 4.0 x16 Slot\*

**10<sup>th</sup> Gen Intel® Core™ Processors**

- 1 x PCI Express 3.0 x16 Slot\*

\* Supports NVMe SSD as boot disks

- 2 x PCI Express 3.0 x1 Slots
- 1 x M.2 Socket (Key E), supports type 2230 WiFi/BT module and Intel® CNVi (Integrated WiFi/BT)
- 15µ Gold Contact in VGA PCIe Slot (PCIe1)

**Graphics**

- Intel® UHD Graphics Built-in Visuals and the VGA outputs can be supported only with processors which are GPU integrated.
  - 11<sup>th</sup> Gen Intel® Core™ Processors support Intel® Xe Graphics Architecture (Gen 12). 10<sup>th</sup> Gen Intel® Core™ Processors support Gen 9 Graphics
  - Graphics, Media & Compute: Microsoft DirectX 12, OpenGL 4.5, Intel® Built In Visuals, Intel® Quick Sync Video, Hybrid / Switchable Graphics, OpenCL 2.1
  - Display & Content Security: Rec. 2020 (Wide Color Gamut), Microsoft PlayReady 3.0, UHD/HDR Blu-ray Disc
  - Dual graphics output: support HDMI and DisplayPort 1.4 ports by independent display controllers
  - Supports HDMI 2.0 with max. resolution up to 4K x 2K (4096x2160) @ 60Hz
  - Supports DisplayPort 1.4 with max. resolution up to 4K x 2K (4096x2304) @ 60Hz
  - Supports Auto Lip Sync, Deep Color (12bpc), xvYCC and HBR (High Bit Rate Audio) with HDMI 2.0 Port (Compliant HDMI monitor is required)
  - Supports HDCP 2.3 with HDMI 2.0 and DisplayPort 1.4 Ports
  - Supports 4K Ultra HD (UHD) playback with HDMI 2.0 and DisplayPort 1.4 Ports
- \* 11<sup>th</sup> Gen Intel® Core™ Processors support HDMI 2.0. 10<sup>th</sup> Gen Intel® Core™ Processors support HDMI 1.4.

**Audio**

- 7.1 CH HD Audio (Realtek ALC897 Audio Codec)
- Supports Surge Protection
- Gold Audio Jacks
- 15µ Gold Audio Connector
- Nahimic Audio

**LAN**

- 2.5 Gigabit LAN 10/100/1000/2500 Mb/s
- Dragon RTL8125BG
- Supports Dragon 2.5G LAN Software
  - Smart Auto Adjust Bandwidth Control
  - Visual User Friendly UI
  - Visual Network Usage Statistics

- Optimized Default Setting for Game, Browser, and Streaming Modes
- User Customized Priority Control
- Supports Wake-On-LAN
- Supports Lightning/ESD Protection
- Supports Energy Efficient Ethernet 802.3az
- Supports PXE

### **Rear Panel I/O**

- 3 x Antenna Mounting Points
- 1 x PS/2 Mouse/Keyboard Port
- 1 x HDMI Port
- 1 x DisplayPort 1.4
- 1 x Optical SPDIF Out Port
- 4 x USB 3.2 Gen1 Ports (ASMedia ASM1074 hub) (Supports ESD Protection)
- 2 x USB 2.0 Ports (Supports ESD Protection)
- 1 x RJ-45 LAN Port with LED (ACT/LINK LED and SPEED LED)
- HD Audio Jacks: Rear Speaker / Central / Bass / Line in / Front Speaker / Microphone (Gold Audio Jacks)

### **Storage**

- 6 x SATA3 6.0 Gb/s Connectors, support Intel Rapid Storage Technology 18, NCQ, AHCI and Hot Plug\*
  - \* If M2\_2 is occupied by a SATA-type M.2 device, SATA3\_1 will be disabled.
- 1 x Hyper M.2 Socket (M2\_1), supports M Key type 2242/2260/2280 M.2 PCI Express module up to Gen4 x4 (64 Gb/s) (with 11<sup>th</sup> Gen Intel® Core™ Processors) or Gen3 x4 (32 Gb/s) (with 10<sup>th</sup> Gen Intel® Core™ Processors)\*\*
- 1 x Ultra M.2 Socket (M2\_2), supports M Key type 2280 M.2 SATA3 6.0 Gb/s module and M.2 PCI Express module up to Gen3 x4 (32 Gb/s)\*\*
  - \*\* M2\_1 supports Intel® Optane™ Technology (with 10<sup>th</sup> Gen Intel® Core™ Processors)
  - \*\* Supports NVMe SSD as boot disks
  - \*\* Supports ASRock U.2 Kit

**Connector**

- 1 x SPI TPM Header
- 1 x Chassis Intrusion and Speaker Header
- 2 x RGB LED Headers
- \* Support in total up to 12V/3A, 36W LED Strip
  - 2 x Addressable LED Headers
- \* Support in total up to 5V/3A, 15W LED Strip
  - 1 x CPU Fan Connector (4-pin)
- \* The CPU Fan Connector supports the CPU fan of maximum 1A (12W) fan power.
  - 1 x CPU/Water Pump Fan Connector (4-pin) (Smart Fan Speed Control)
- \* The CPU/Water Pump Fan supports the water cooler fan of maximum 2A (24W) fan power.
  - 3 x Chassis/Water Pump Fan Connectors (4-pin) (Smart Fan Speed Control)
- \* The Chassis/Water Pump Fan supports the water cooler fan of maximum 2A (24W) fan power.
- \* CPU\_FAN2/WP, CHA\_FAN1/WP, CHA\_FAN2/WP and CHA\_FAN3/WP can auto detect if 3-pin or 4-pin fan is in use.
  - 1 x 24 pin ATX Power Connector (Hi-Density Power Connector)
  - 1 x 8 pin 12V Power Connector (Hi-Density Power Connector)
  - 1 x Front Panel Audio Connector (15 $\mu$  Gold Audio Connector)
  - 2 x USB 2.0 Headers (Support 4 USB 2.0 ports) (Supports ESD Protection)
  - 1 x USB 3.2 Gen1 Header (Supports 2 USB 3.2 Gen1 ports) (Supports ESD Protection)
  - 1 x Front Panel Type C USB 3.2 Gen2x2 Header (20 Gb/s) (Supports ESD Protection)

**BIOS  
Feature**

- AMI UEFI Legal BIOS with multilingual GUI support
- ACPI 6.0 Compliant wake up events
- SMBIOS 2.7 Support
- CPU Core/Cache, CPU GT, VCCSA, DRAM, VCCIO, VC-CIO 1 2, VPPM, VCCIN AUX Voltage Multi-adjustment

**Hardware Monitor**

- Fan Tachometer: CPU, CPU/Water Pump, Chassis/Water Pump Fans
- Quiet Fan (Auto adjust chassis fan speed by CPU temperature): CPU, CPU/Water Pump, Chassis/Water Pump Fans
- Fan Multi-Speed Control: CPU, CPU/Water Pump, Chassis/Water Pump Fans
- CASE OPEN detection
- Voltage monitoring: CPU Vcore, VCCIN AUX, DRAM, VC-CIO, VPPM, VCCSA, CPU PLL, +12V, +5V, +3.3V

**OS**

- Microsoft® Windows® 10 64-bit

**Certifications**

- FCC, CE
- ErP/EuP ready (ErP/EuP ready power supply is required)

\* For detailed product information, please visit our website: <http://www.asrock.com>



*Please realize that there is a certain risk involved with overclocking, including adjusting the setting in the BIOS, applying Untied Overclocking Technology, or using third-party overclocking tools. Overclocking may affect your system's stability, or even cause damage to the components and devices of your system. It should be done at your own risk and expense. We are not responsible for possible damage caused by overclocking.*

### 1.3 Motherboard Layout

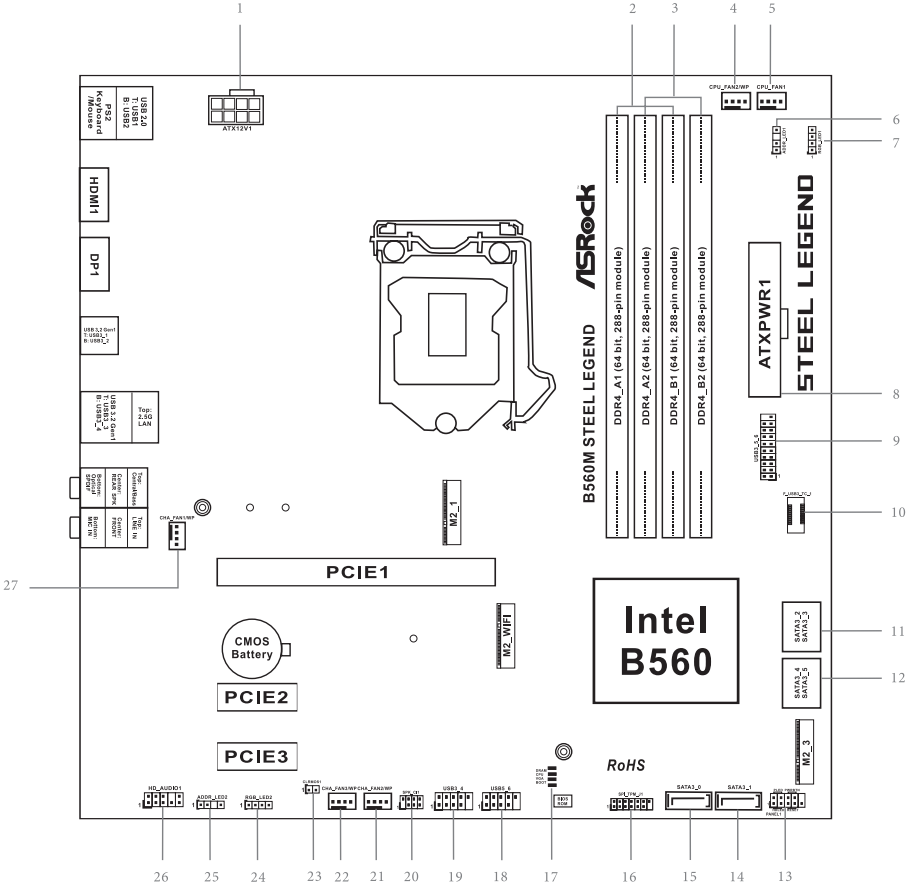

No.	Description
1	12V Power Connector (ATX12V1)
2	2 x 288-pin DDR4 DIMM Slots (DDR4_A1, DDR4_B1)
3	2 x 288-pin DDR4 DIMM Slots (DDR4_A2, DDR4_B2)
4	CPU/Water Pump Fan Connector (CPU_FAN2/WP)
5	CPU Fan Connector (CPU_FAN1)
6	Addressable LED Header (ADDR_LED1)
7	RGB LED Header (RGB_LED1)
8	ATX Power Connector (ATXPWR1)
9	USB 3.2 Gen1 Header (USB3_5_6)
10	Front Panel Type C USB 3.2 Gen2x2 Header (F_USB3_TC_1)
11	SATA3 Connector (SATA3_2) (Upper), SATA3 Connector (SATA3_3) (Lower)
12	SATA3 Connector (SATA3_4) (Upper), SATA3 Connector (SATA3_5) (Lower)
13	System Panel Header (PANEL1)
14	SATA3 Connector (SATA3_1)
15	SATA3 Connector (SATA3_0)
16	SPI TPM Header (SPI_TPM_J1)
17	POST Status Checker (PSC)
18	USB 2.0 Header (USB5_6)
19	USB 2.0 Header (USB3_4)
20	Chassis Intrusion and Speaker Header (SPK_CI1)
21	Chassis/Water Pump Fan Connector (CHA_FAN2/WP)
22	Chassis/Water Pump Fan Connector (CHA_FAN3/WP)
23	Clear CMOS Jumper (CLRMOS1)
24	RGB LED Header (RGB_LED2)
25	Addressable LED Header (ADDR_LED2)
26	Front Panel Audio Header (HD_AUDIO1)
27	Chassis/Water Pump Fan Connector (CHA_FAN1/WP)

## 1.4 I/O Panel

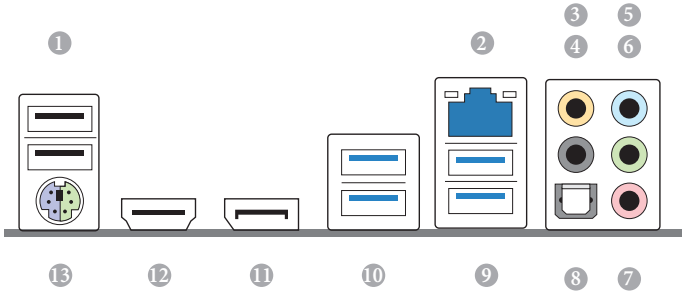

No.	Description	No.	Description
1	USB 2.0 Ports (USB12)	8	Optical SPDIF Out Port
2	2.5G LAN RJ-45 Port (Dragon RTL8125BG)*	9	USB 3.2 Gen1 Ports (USB3_3_4)
3	Central / Bass (Orange)	10	USB 3.2 Gen1 Ports (USB3_1_2)
4	Rear Speaker (Black)	11	DisplayPort 1.4
5	Line In (Light Blue)	12	HDMI Port
6	Front Speaker (Lime)**	13	PS/2 Mouse/Keyboard Port
7	Microphone (Pink)		

\* There are two LEDs on each LAN port. Please refer to the table below for the LAN port LED indications.

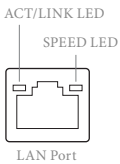

Activity / Link LED		Speed LED	
Status	Description	Status	Description
Off	No Link	Off	10Mbps connection
Blinking	Data Activity	Orange	100Mbps/1Gbps connection
On	Link	Green	2.5Gbps connection



*\*\* If you use a 2-channel speaker, please connect the speaker's plug into "Front Speaker Jack". See the table below for connection details in accordance with the type of speaker you use.*

<b>Audio Output Channels</b>	<b>Front Speaker (No. 6)</b>	<b>Rear Speaker (No. 4)</b>	<b>Central / Bass (No. 3)</b>	<b>Line In (No. 5)</b>
2	V	--	--	--
4	V	V	--	--
6	V	V	V	--
8	V	V	V	V

## Chapter 2 Installation

This is a Micro ATX form factor motherboard. Before you install the motherboard, study the configuration of your chassis to ensure that the motherboard fits into it.

### Pre-installation Precautions

Take note of the following precautions before you install motherboard components or change any motherboard settings.

- Make sure to unplug the power cord before installing or removing the motherboard components. Failure to do so may cause physical injuries and damages to motherboard components.
- In order to avoid damage from static electricity to the motherboard's components, NEVER place your motherboard directly on a carpet. Also remember to use a grounded wrist strap or touch a safety grounded object before you handle the components.
- Hold components by the edges and do not touch the ICs.
- Whenever you uninstall any components, place them on a grounded anti-static pad or in the bag that comes with the components.
- When placing screws to secure the motherboard to the chassis, please do not over-tighten the screws! Doing so may damage the motherboard.

## 2.1 Installing the CPU



1. Before you insert the 1200-Pin CPU into the socket, please check if the **PnP cap** is on the socket, if the CPU surface is unclean, or if there are any **bent pins** in the socket. Do not force to insert the CPU into the socket if above situation is found. Otherwise, the CPU will be seriously damaged.
2. Unplug all power cables before installing the CPU.

1

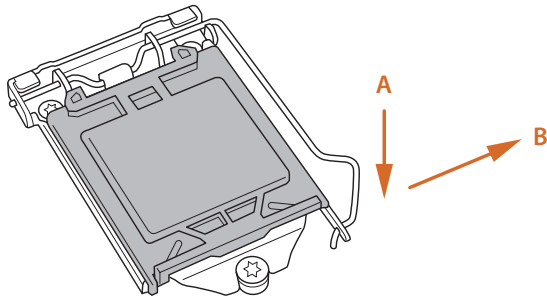

2

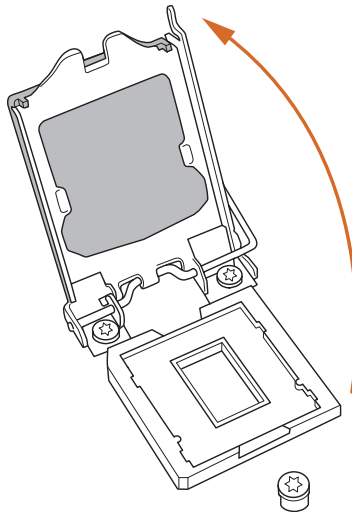

3

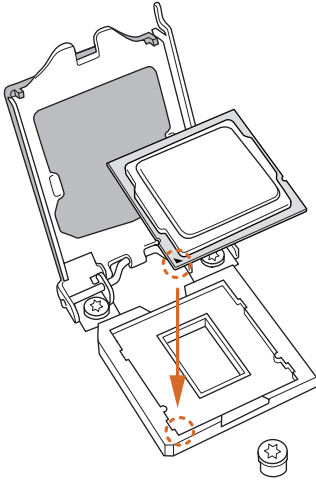

4

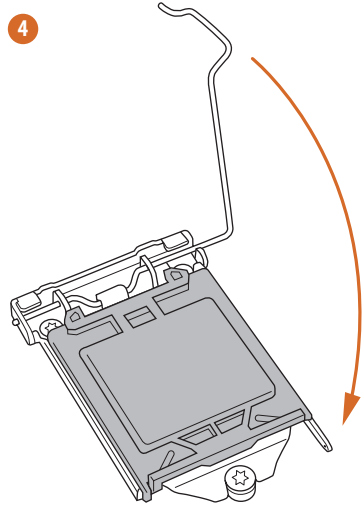

5

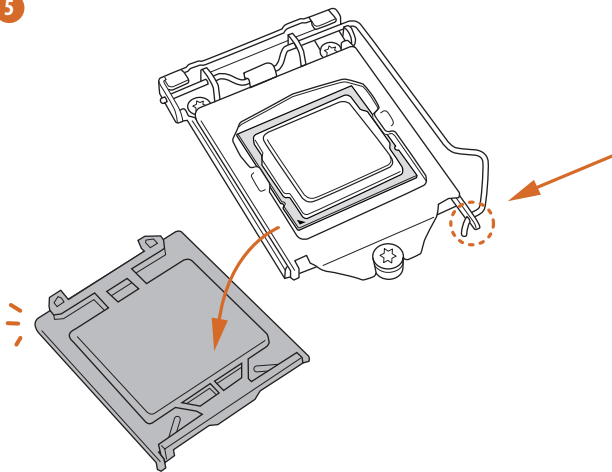



*Please save and replace the cover if the processor is removed. The cover must be placed if you wish to return the motherboard for after service.*

## 2.2 Installing the CPU Fan and Heatsink

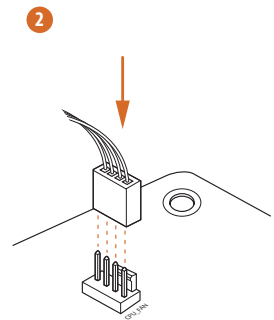
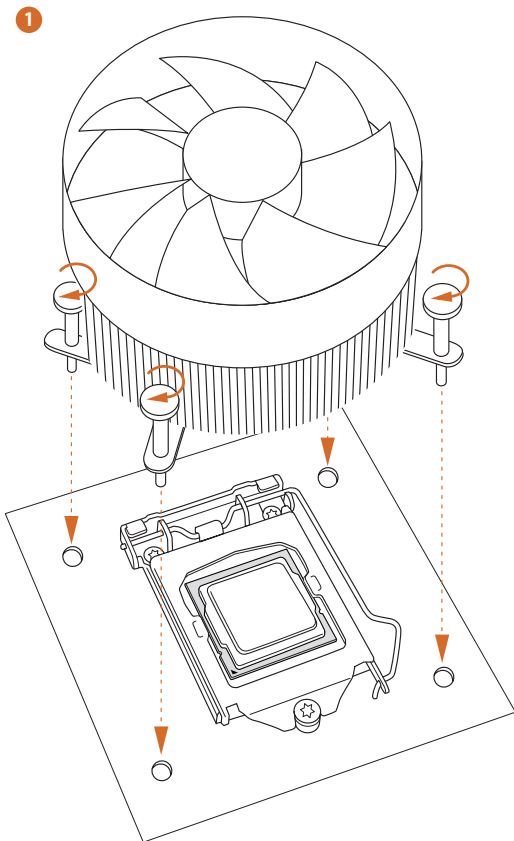
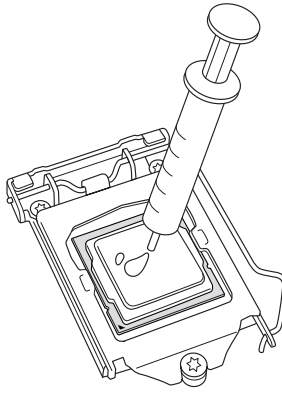

## 2.3 Installing Memory Modules (DIMM)

This motherboard provides four 288-pin DDR4 (Double Data Rate 4) DIMM slots, and supports Dual Channel Memory Technology.



1. For dual channel configuration, you always need to install identical (the same brand, speed, size and chip-type) DDR4 DIMM pairs.
2. It is unable to activate Dual Channel Memory Technology with only one or three memory module installed.
3. It is not allowed to install a DDR, DDR2 or DDR3 memory module into a DDR4 slot; otherwise, this motherboard and DIMM may be damaged.

### Dual Channel Memory Configuration

Priority	DDR4_A1	DDR4_A2	DDR4_B1	DDR4_B2
1		Populated		Populated
2	Populated	Populated	Populated	Populated



*The DIMM only fits in one correct orientation. It will cause permanent damage to the motherboard and the DIMM if you force the DIMM into the slot at incorrect orientation.*

1

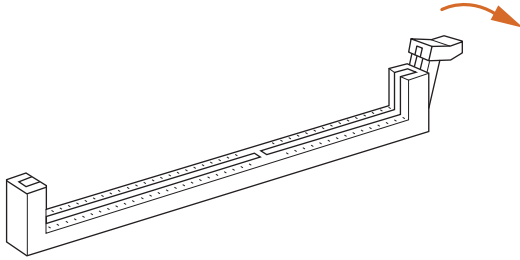

2

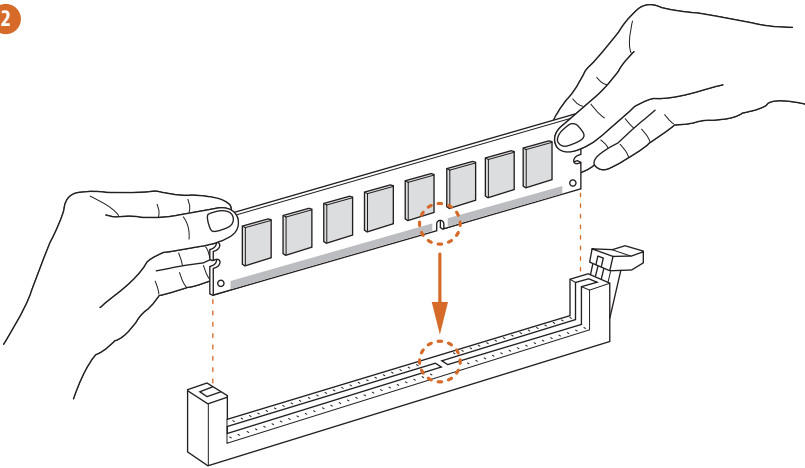

3

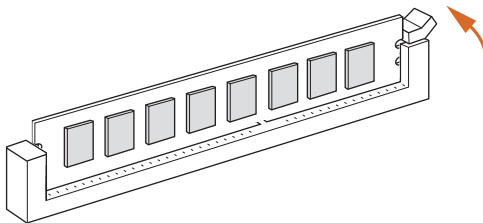



## 2.4 Expansion Slots (PCI Express Slots)

There are 3 PCI Express slots on the motherboard.



*Before installing an expansion card, please make sure that the power supply is switched off or the power cord is unplugged. Please read the documentation of the expansion card and make necessary hardware settings for the card before you start the installation.*

### PCIe slots:

#### 11<sup>th</sup> Gen Intel® Core™ Processors:

PCIE1 (PCIe 4.0 x16 slot) is used for PCI Express x16 lane width graphics cards.

PCIE2 (PCIe 3.0 x1 slot) is used for PCI Express x1 lane width cards.

PCIE3 (PCIe 3.0 x1 slot) is used for PCI Express x1 lane width cards.

#### 10<sup>th</sup> Gen Intel® Core™ Processors:

PCIE1 (PCIe 3.0 x16 slot) is used for PCI Express x16 lane width graphics cards.

PCIE2 (PCIe 3.0 x1 slot) is used for PCI Express x1 lane width cards.

PCIE3 (PCIe 3.0 x1 slot) is used for PCI Express x1 lane width cards.



*For a better thermal environment, please connect a chassis fan to the motherboard's chassis fan connector (CHA\_FAN1/WP, CHA\_FAN2/WP or CHA\_FAN3/WP) when using multiple graphics cards.*

## 2.5 Jumpers Setup

The illustration shows how jumpers are setup. When the jumper cap is placed on the pins, the jumper is “Short”. If no jumper cap is placed on the pins, the jumper is “Open”.

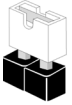

Short



Open

Clear CMOS Jumper  
(CLRMOSE1)  
(see p.7, No. 23)



2-pin Jumper

Short: Clear CMOS  
Open: Default

CLRMOSE1 allows you to clear the data in CMOS. The data in CMOS includes system setup information such as system password, date, time, and system setup parameters. To clear and reset the system parameters to default setup, please turn off the computer and unplug the power cord, then use a jumper cap to short the pins on CLRMOSE1 for 3 seconds. Please remember to remove the jumper cap after clearing the CMOS. If you need to clear the CMOS when you just finish updating the BIOS, you must boot up the system first, and then shut it down before you do the clear-CMOS action.



*If you clear the CMOS, the case open may be detected. Please adjust the BIOS option “Clear Status” to clear the record of previous chassis intrusion status.*

## 2.6 Onboard Headers and Connectors



Onboard headers and connectors are NOT jumpers. Do NOT place jumper caps over these headers and connectors. Placing jumper caps over the headers and connectors will cause permanent damage to the motherboard.

System Panel Header  
(9-pin PANEL1)  
(see p.7, No. 13)

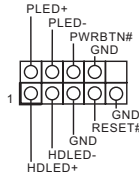

Connect the power button, reset button and system status indicator on the chassis to this header according to the pin assignments below. Note the positive and negative pins before connecting the cables.



**PWRBTN (Power Button):**

Connect to the power button on the chassis front panel. You may configure the way to turn off your system using the power button.

**RESET (Reset Button):**

Connect to the reset button on the chassis front panel. Press the reset button to restart the computer if the computer freezes and fails to perform a normal restart.

**PLED (System Power LED):**

Connect to the power status indicator on the chassis front panel. The LED is on when the system is operating. The LED keeps blinking when the system is in S1/S3 sleep state. The LED is off when the system is in S4 sleep state or powered off (S5).

**HDLED (Hard Drive Activity LED):**

Connect to the hard drive activity LED on the chassis front panel. The LED is on when the hard drive is reading or writing data.

The front panel design may differ by chassis. A front panel module mainly consists of power button, reset button, power LED, hard drive activity LED, speaker and etc. When connecting your chassis front panel module to this header, make sure the wire assignments and the pin assignments are matched correctly.

Chassis Intrusion and  
Speaker Header  
(7-pin SPK\_C11)  
(see p.7, No. 20)

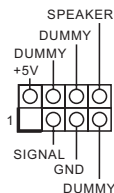

Please connect the chassis intrusion and the chassis speaker to this header.

Serial ATA3 Connectors

Right Angle:

- (SATA3\_2: see p.7, No. 11) (Upper)
- (SATA3\_3: see p.7, No. 11) (Lower)
- (SATA3\_4: see p.7, No. 12) (Upper)
- (SATA3\_5: see p.7, No. 12) (Lower)

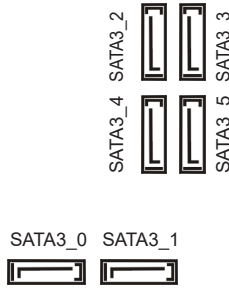

These six SATA3 connectors support SATA data cables for internal storage devices with up to 6.0 Gb/s data transfer rate.  
 \* If M2\_2 is occupied by a SATA-type M.2 device, SATA3\_1 will be disabled.

Vertical:

- (SATA3\_0: see p.7, No. 15)
- (SATA3\_1: see p.7, No. 14)

USB 2.0 Headers

- (9-pin USB3\_4) (see p.7, No. 19)
- (9-pin USB5\_6) (see p.7, No. 18)

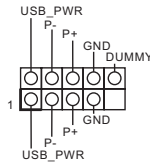

There are two headers on this motherboard. Each USB 2.0 header can support two ports.

USB 3.2 Gen1 Header

- (19-pin USB3\_5\_6) (see p.7, No. 9)

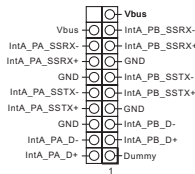

There is one header on this motherboard. This USB 3.2 Gen1 header can support two ports.

Front Panel Type C USB

- 3.2 Gen2x2 Header (20-pin F\_USB3\_TC\_1) (see p.7, No. 10)

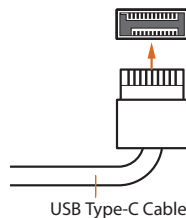

There is one Front Panel Type C USB 3.2 Gen2x2 Header on this motherboard. This header is used for connecting a USB 3.2 Gen2x2 module for additional USB 3.2 Gen2x2 ports.

Front Panel Audio Header  
(9-pin HD\_AUDIO1)  
(see p.7, No. 26)

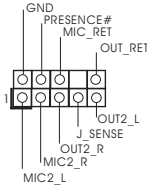

This header is for connecting audio devices to the front audio panel.



1. High Definition Audio supports Jack Sensing, but the panel wire on the chassis must support HDA to function correctly. Please follow the instructions in our manual and chassis manual to install your system.
2. If you use an AC'97 audio panel, please install it to the front panel audio header by the steps below:
  - A. Connect Mic\_IN (MIC) to MIC2\_L.
  - B. Connect Audio\_R (RIN) to OUT2\_R and Audio\_L (LIN) to OUT2\_L.
  - C. Connect Ground (GND) to Ground (GND).
  - D. MIC\_RET and OUT\_RET are for the HD audio panel only. You don't need to connect them for the AC'97 audio panel.
  - E. To activate the front mic, go to the "FrontMic" Tab in the Realtek Control panel and adjust "Recording Volume".

Chassis/Water Pump Fan Connectors  
(4-pin CHA\_FAN1/WP)  
(see p.7, No. 27)

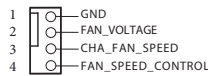

This motherboard provides three 4-Pin water cooling chassis fan connectors. If you plan to connect a 3-Pin chassis water cooler fan, please connect it to Pin 1-3.

(4-pin CHA\_FAN2/WP)  
(see p.7, No. 21)  
(4-pin CHA\_FAN3/WP)  
(see p.7, No. 22)

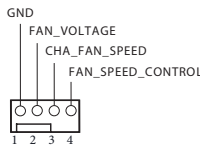

CPU Fan Connector  
(4-pin CPU\_FAN1)  
(see p.7, No. 5)

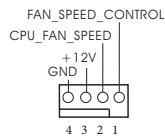

This motherboard provides a 4-Pin CPU fan (Quiet Fan) connector. If you plan to connect a 3-Pin CPU fan, please connect it to Pin 1-3.

CPU/Water Pump Fan Connector  
(4-pin CPU\_FAN2/WP)  
(see p.7, No. 4)

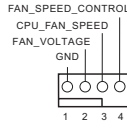

This motherboard provides a 4-Pin water cooling CPU fan connector. If you plan to connect a 3-Pin CPU water cooler fan, please connect it to Pin 1-3.

ATX Power Connector  
(24-pin ATXPWR1)  
(see p.7, No. 8)

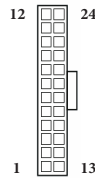

This motherboard provides a 24-pin ATX power connector. To use a 20-pin ATX power supply, please plug it along Pin 1 and Pin 13.

ATX 12V Power Connector  
(8-pin ATX12V1)  
(see p.7, No. 1)

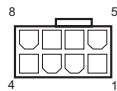

This motherboard provides a 8-pin ATX 12V power connector. To use a 4-pin ATX power supply, please plug it along Pin 1 and Pin 5.

**\*Warning: Please make sure that the power cable connected is for the CPU and not the graphics card. Do not plug the PCIe power cable to this connector.**

SPI TPM Header  
(13-pin SPI\_TPM\_J1)  
(see p.7, No. 16)

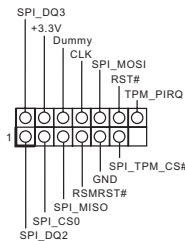

This connector supports SPI Trusted Platform Module (TPM) system, which can securely store keys, digital certificates, passwords, and data. A TPM system also helps enhance network security, protects digital identities, and ensures platform integrity.

---

RGB LED Headers  
(4-pin RGB\_LED1)  
(see p.7, No. 7)



(4-pin RGB\_LED2)  
(see p.7, No. 24)



These two RGB headers are used to connect RGB LED extension cable which allows users to choose from various LED lighting effects.

**Caution: Never install the RGB LED cable in the wrong orientation; otherwise, the cable may be damaged.**

\*Please refer to page 47 for further instructions on these two headers.

---

Addressable LED Headers  
(3-pin ADDR\_LED1)  
(see p.7, No. 6)

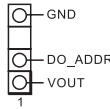

(3-pin ADDR\_LED2)  
(see p.7, No. 25)

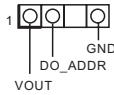

These two Addressable headers are used to connect Addressable LED extension cable which allows users to choose from various LED lighting effects.

**Caution: Never install the Addressable LED cable in the wrong orientation; otherwise, the cable may be damaged.**

\*Please refer to page 48 for further instructions on this header.

## 2.7 Post Status Checker

Post Status Checker (PSC) diagnoses the computer when users power on the machine. It emits a red light to indicate whether the CPU, memory, VGA or storage is dysfunctional. The lights go off if the four mentioned above are functioning normally.



## 2.8 M.2 WiFi/BT Module and Intel® CNVi (Integrated WiFi/BT) Installation Guide

The M.2, also known as the Next Generation Form Factor (NGFF), is a small size and versatile card edge connector that aims to replace mPCIe and mSATA. The M.2 Socket (Key E) supports type 2230 WiFi/BT module and Intel® CNVi (Integrated WiFi/BT).

\* The M.2 socket does not support SATA M.2 SSDs.



*Before you install Intel® Integrated Connectivity (CNVi) module, be sure to turn off the AC power.*

### Installing the WiFi/BT module or Intel® CNVi (Integrated WiFi/BT)

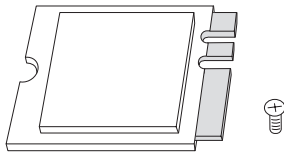

#### Step 1

Prepare a type 2230 WiFi/BT module or Intel® CNVi (Integrated WiFi/BT) and the screw.

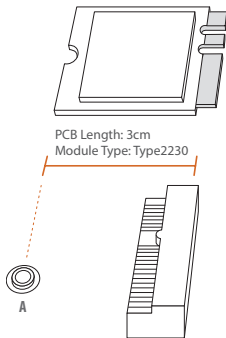

#### Step 2

Find the nut location to be used.

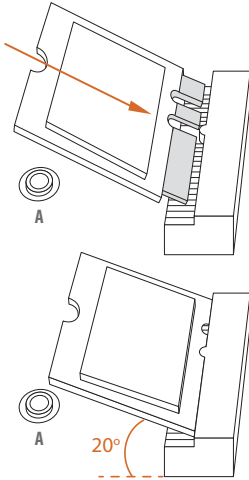
**Step 3**

Gently insert the WiFi/BT module or Intel® CNVi (Integrated WiFi/BT) into the M.2 slot. Please be aware that the module only fits in one orientation.

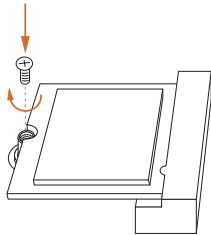
**Step 4**

Tighten the screw with a screwdriver to secure the module into place. Please do not overtighten the screw as this might damage the module.

## 2.9 M.2\_SSD (NGFF) Module Installation Guide (M2\_1)

The M.2, also known as the Next Generation Form Factor (NGFF), is a small size and versatile card edge connector that aims to replace mPCIe and mSATA. The Hyper M.2 Sockets (M2\_1) supports M Key type 2242/2260/2280 M.2 PCI Express module up to Gen4x4 (64 Gb/s) (with 11<sup>th</sup> Gen Intel® Core™ Processors) or Gen3x4 (32 Gb/s) (with 10<sup>th</sup> Gen Intel® Core™ Processors).

### Installing the M.2\_SSD (NGFF) Module

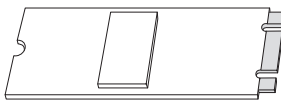

#### Step 1

Prepare a M.2\_SSD (NGFF) module and the screw.

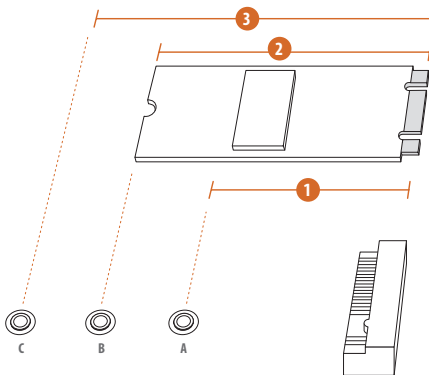

#### Step 2

Depending on the PCB type and length of your M.2\_SSD (NGFF) module, find the corresponding nut location to be used.

No.	1	2	3
Nut Location	A	B	C
PCB Length	4.2cm	6cm	8cm
Module Type	Type 2242	Type2260	Type 2280

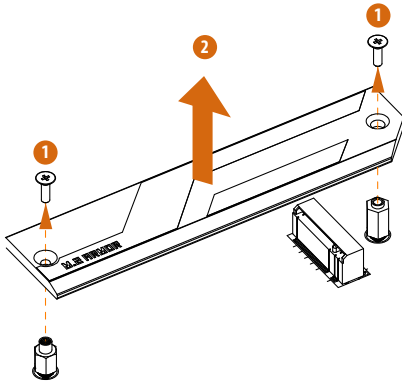
**Step 3**

Before installing a M.2 (NGFF) SSD module, please loosen the screws to remove the M.2 heatsink.

\*Please remove the protective films on the bottom side of the M.2 heatsink before you install a M.2 SSD module.

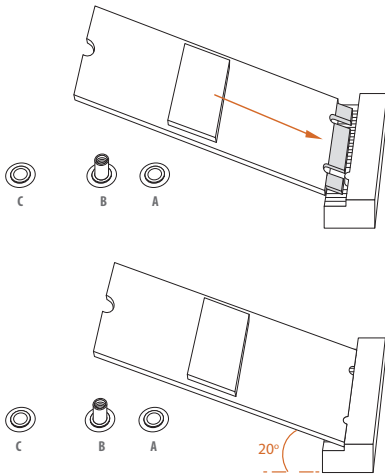
**Step 4**

Prepare the M.2 standoff that comes with the package. Then hand tighten the standoff into the desired nut location on the motherboard. Align and gently insert the M.2 (NGFF) SSD module into the M.2 slot. Please be aware that the M.2 (NGFF) SSD module only fits in one orientation.

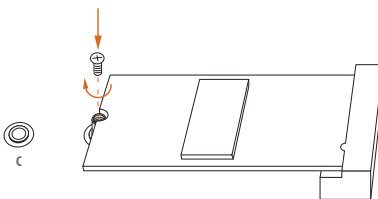
**Step 5**

Tighten the screw with a screwdriver to secure the module into place. Please do not overtighten the screw as this might damage the module.

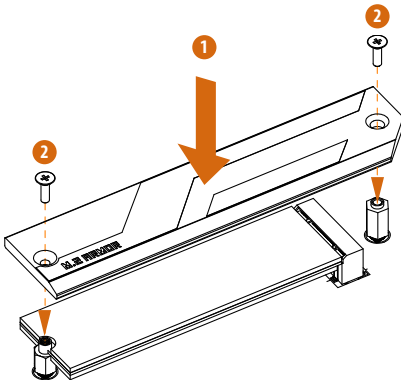

### **Step 6**

Tighten the screw with a screwdriver to secure the module and M.2 heatsink into place. Please do not overtighten the screw as this might damage the module and M.2 heatsink.

## M.2\_SSD (NGFF) Module Support List

Vendor	Interface	P/N
ADATA	PCIe3 x4	ASX7000NP-128GT-C
ADATA	PCIe3 x4	ASX8000NP-256GM-C
ADATA	PCIe3 x4	ASX7000NP-256GT-C
ADATA	PCIe3 x4	ASX8000NP-512GM-C
ADATA	PCIe3 x4	ASX7000NP-512GT-C
Apacer	PCIe3 x4	AP240GZ280
Corsair	PCIe3 x4	CSSD-F240GBMP500
Intel	PCIe3 x4	SSDPEKKF256G7
Intel	PCIe3 x4	SSDPEKKF512G7
Kingston	PCIe3 x4	SKC1000/480G
Kingston	PCIe2 x4	SH2280S3/480G
OCZ	PCIe3 x4	RVD400 -M2280-512G (NVME)
PATRIOT	PCIe3 x4	PH240GPM280SSDR NVME
Plextor	PCIe3 x4	PX-128M8PeG
Plextor	PCIe3 x4	PX-1TM8PeG
Plextor	PCIe3 x4	PX-256M8PeG
Plextor	PCIe3 x4	PX-512M8PeG
Plextor	PCIe	PX-G256M6e
Plextor	PCIe	PX-G512M6e
Samsung	PCIe3 x4	SM961 MZVPW128HEGM (NVM)
Samsung	PCIe3 x4	PM961 MZVLW128HEGR (NVME)
Samsung	PCIe3 x4	960 EVO (MZ-V6E250) (NVME)
Samsung	PCIe3 x4	960 EVO (MZ-V6E250BW) (NVME)
Samsung	PCIe3 x4	SM951 (NVME)
Samsung	PCIe3 x4	SM951 (MZHPV256HDGL)
Samsung	PCIe3 x4	SM951 (MZHPV512HDGL)
Samsung	PCIe3 x4	SM951 (NVME)
Samsung	PCIe x4	XP941-512G (MZHPU512HCGL)
SanDisk	PCIe	SD6PP4M-128G
SanDisk	PCIe	SD6PP4M-256G
TEAM	PCIe3 x4	TM8FP2240G0C101
TEAM	PCIe3 x4	TM8FP2480G0C110
WD	PCIe3 x4	WDS256G1X0C-00ENX0 (NVME)
WD	PCIe3 x4	WDS512G1X0C-00ENX0 (NVME)

For the latest updates of M.2\_SSD (NFGG) module support list, please visit our website for details: <http://www.asrock.com>

## 2.10 M.2\_SSD (NGFF) Module Installation Guide (M2\_2)

The M.2, also known as the Next Generation Form Factor (NGFF), is a small size and versatile card edge connector that aims to replace mPCIe and mSATA. The Ultra M.2 Sockets (M2\_2) supports M Key type 2280 M.2 SATA3 6.0 Gb/s module and M.2 PCI Express module up to Gen3 x4 (32 Gb/s).

\* If M2\_2 is occupied by a SATA-type M.2 device, SATA3\_1 will be disabled.

### Installing the M.2\_SSD (NGFF) Module

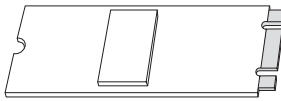

#### Step 1

Prepare a M.2\_SSD (NGFF) module and the screw.

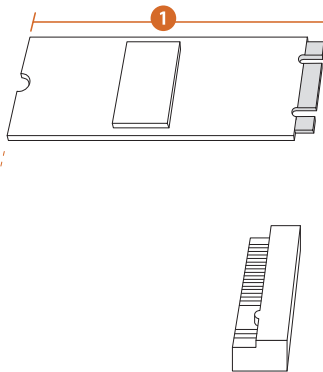

#### Step 2

Depending on the PCB type and length of your M.2\_SSD (NGFF) module, find the corresponding nut location to be used.

No.	1
Nut Location	A
PCB Length	8cm
Module Type	Type2280

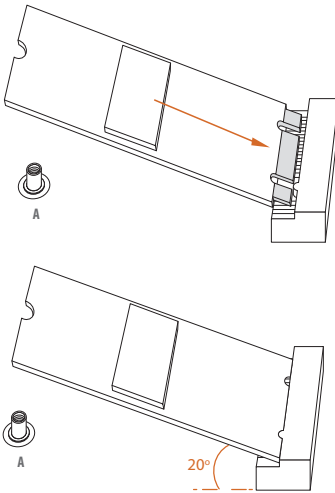
**Step 3**

Align and gently insert the M.2 (NGFF) SSD module into the M.2 slot. Please be aware that the M.2 (NGFF) SSD module only fits in one orientation.

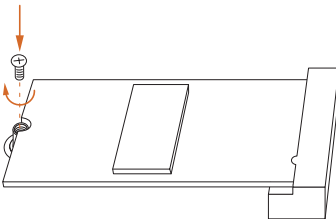
**Step 4**

Tighten the screw with a screwdriver to secure the module into place. Please do not overtighten the screw as this might damage the module.



## M.2\_SSD (NGFF) Module Support List

Vendor	Interface	P/N
ADATA	SATA3	AXNS330E-32GM-B
ADATA	SATA3	AXNS381E-128GM-B
ADATA	SATA3	AXNS381E-256GM-B
ADATA	SATA3	ASU800NS38-256GT-C
ADATA	SATA3	ASU800NS38-512GT-C
ADATA	PCIe3 x4	ASX7000NP-128GT-C
ADATA	PCIe3 x4	ASX8000NP-256GM-C
ADATA	PCIe3 x4	ASX7000NP-256GT-C
ADATA	PCIe3 x4	ASX8000NP-512GM-C
ADATA	PCIe3 x4	ASX7000NP-512GT-C
Apacer	PCIe3 x4	AP240GZ280
Corsair	PCIe3 x4	CSSD-F240GBMP500
Crucial	SATA3	CT120M500SSD4
Crucial	SATA3	CT240M500SSD4
Intel	SATA3	Intel SSDSCKGW080A401/80G
Intel	PCIe3 x4	SSDPEKKF256G7
Intel	PCIe3 x4	SSDPEKKF512G7
Kingston	SATA3	SM2280S3
Kingston	PCIe3 x4	SKC1000/480G
Kingston	PCIe2 x4	SH2280S3/480G
OCZ	PCIe3 x4	RVD400 -M2280-512G (NVME)
PATRIOT	PCIe3 x4	PH240GPM280SSDR NVME
Plextor	PCIe3 x4	PX-128M8PeG
Plextor	PCIe3 x4	PX-1TM8PeG
Plextor	PCIe3 x4	PX-256M8PeG
Plextor	PCIe3 x4	PX-512M8PeG
Plextor	PCIe	PX-G256M6e
Plextor	PCIe	PX-G512M6e
Samsung	PCIe3 x4	SM961 MZVPW128HEGM (NVM)
Samsung	PCIe3 x4	PM961 MZVLW128HEGR (NVME)
Samsung	PCIe3 x4	960 EVO (MZ-V6E250) (NVME)
Samsung	PCIe3 x4	960 EVO (MZ-V6E250BW) (NVME)
Samsung	PCIe3 x4	SM951 (NVME)
Samsung	PCIe3 x4	SM951 (MZHPV256HDGL)
Samsung	PCIe3 x4	SM951 (MZHPV512HDGL)
Samsung	PCIe3 x4	SM951 (NVME)
Samsung	PCIe x4	XP941-512G (MZHPU512HCGL)
SanDisk	PCIe	SD6PP4M-128G
SanDisk	PCIe	SD6PP4M-256G
Team	SATA3	TM4PS4128GMC105
Team	SATA3	TM4PS4256GMC105
Team	SATA3	TM8PS4128GMC105
Team	SATA3	TM8PS4256GMC105

TEAM	PCIe3 x4	TM8FP2240G0C101
TEAM	PCIe3 x4	TM8FP2480GC110
Transcend	SATA3	TS256GMTS400
Transcend	SATA3	TS512GMTS600
Transcend	SATA3	TS512GMTS800
V-Color	SATA3	VLM100-120G-2280B-RD
V-Color	SATA3	VLM100-240G-2280RGB
V-Color	SATA3	VSM100-240G-2280
V-Color	SATA3	VLM100-240G-2280B-RD
WD	SATA3	WDS100T1B0B-00AS40
WD	SATA3	WDS240G1G0B-00RC30
WD	PCIe3 x4	WDS256G1X0C-00ENX0 (NVME)
WD	PCIe3 x4	WDS512G1X0C-00ENX0 (NVME)

For the latest updates of M.2\_SSD (NFGG) module support list, please visit our website for details: <http://www.asrock.com>

---

## Chapter 3 Software and Utilities Operation

### 3.1 Installing Drivers

The Support CD that comes with the motherboard contains necessary drivers and useful utilities that enhance the motherboard's features.

#### Running The Support CD

To begin using the support CD, insert the CD into your CD-ROM drive. The CD automatically displays the Main Menu if "AUTORUN" is enabled in your computer. If the Main Menu does not appear automatically, locate and double click on the file "ASRSETUP.EXE" in the Support CD to display the menu.

#### Drivers Menu

The drivers compatible to your system will be auto-detected and listed on the support CD driver page. Please click **Install All** or follow the order from top to bottom to install those required drivers. Therefore, the drivers you install can work properly.

#### Utilities Menu

The Utilities Menu shows the application software that the motherboard supports. Click on a specific item then follow the installation wizard to install it.

## 3.2 ASRock Motherboard Utility (A-Tuning)

ASRock Motherboard Utility (A-Tuning) is ASRock's multi purpose software suite with a new interface, more new features and improved utilities.

### 3.2.1 Installing ASRock Motherboard Utility (A-Tuning)

ASRock Motherboard Utility (A-Tuning) can be downloaded from ASRock Live Update & APP Shop. After the installation, you will find the icon "ASRock Motherboard Utility (A-Tuning)" on your desktop. Double-click the "ASRock Motherboard Utility (A-Tuning)"  icon, ASRock Motherboard Utility (A-Tuning) main menu will pop up.

### 3.2.2 Using ASRock Motherboard Utility (A-Tuning)

There are five sections in ASRock Motherboard Utility (A-Tuning) main menu: Operation Mode, OC Tweaker, System Info, FAN-Tastic Tuning and Settings.

#### Operation Mode

Choose an operation mode for your computer.

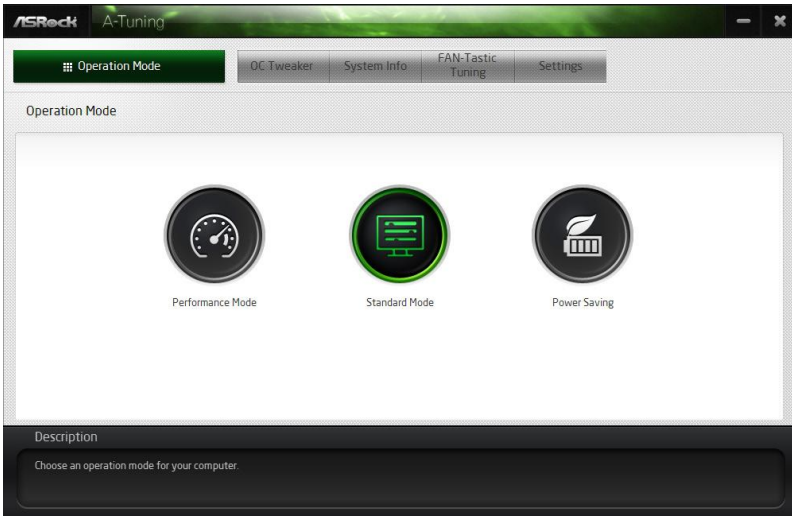

## OC Tweaker

Configurations for overlocking the system.

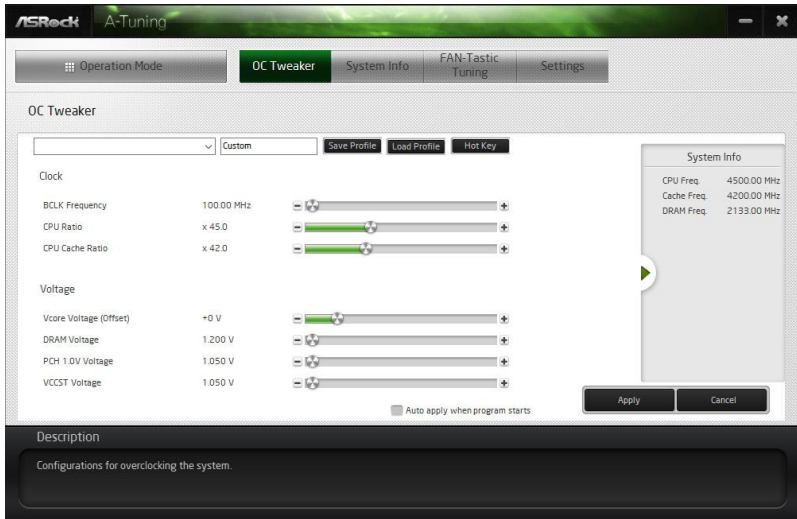

## System Info

View information about the system.

\*The System Browser tab may not appear for certain models.

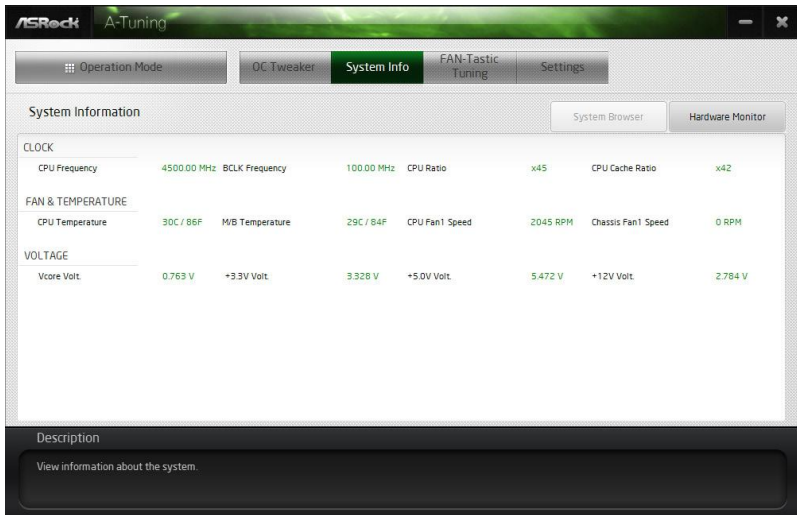

## FAN-Tastic Tuning

Configure up to five different fan speeds using the graph. The fans will automatically shift to the next speed level when the assigned temperature is met.

**FAN-Tastic Tuning**

CPU FAN1

Start FAN Test

Fan Power	Fan Speed
100%	N/A RPM
90%	N/A RPM
80%	N/A RPM
70%	N/A RPM
60%	N/A RPM
50%	N/A RPM
40%	N/A RPM
30%	N/A RPM
20%	N/A RPM
10%	N/A RPM

Auto apply when program starts

Apply Cancel

**Description**

Configure different fan speeds for respective temperatures using the graph. The fans will automatically shift to the next speed level when the assigned temperature is met.

## Settings

Configure ASRock ASRock Motherboard Utility (A-Tuning). Click to select "Auto run at Windows Startup" if you want ASRock Motherboard Utility (A-Tuning) to be launched when you start up the Windows operating system.

**Settings**

Auto run at Windows Startup

Version: 3.0.93

**Description**

Configure ASRock A-Tuning.

## 3.3 ASRock Live Update & APP Shop

The ASRock Live Update & APP Shop is an online store for purchasing and downloading software applications for your ASRock computer. You can quickly and easily install various apps and support utilities. With ASRock Live Update & APP Shop, you can optimize your system and keep your motherboard up to date simply with a few clicks.

Double-click  on your desktop to access ASRock Live Update & APP Shop utility.

*\*You need to be connected to the Internet to download apps from the ASRock Live Update & APP Shop.*

### 3.3.1 UI Overview



Information Panel

**Category Panel:** The category panel contains several category tabs or buttons that when selected the information panel below displays the relative information.

**Information Panel:** The information panel in the center displays data about the currently selected category and allows users to perform job-related tasks.

**Hot News:** The hot news section displays the various latest news. Click on the image to visit the website of the selected news and know more.

### 3.3.2 Apps

When the "Apps" tab is selected, you will see all the available apps on screen for you to download.

#### Installing an App

##### Step 1

Find the app you want to install.



The most recommended app appears on the left side of the screen. The other various apps are shown on the right. Please scroll up and down to see more apps listed.

You can check the price of the app and whether you have already installed it or not.

**Free** - The red icon displays the price or "Free" if the app is free of charge.

**Installed** - The green "Installed" icon means the app is installed on your computer.

##### Step 2

Click on the app icon to see more details about the selected app.



### Step 3

If you want to install the app, click on the red icon  to start downloading.



### Step 4

When installation completes, you can find the green "Installed" icon appears on the upper right corner.

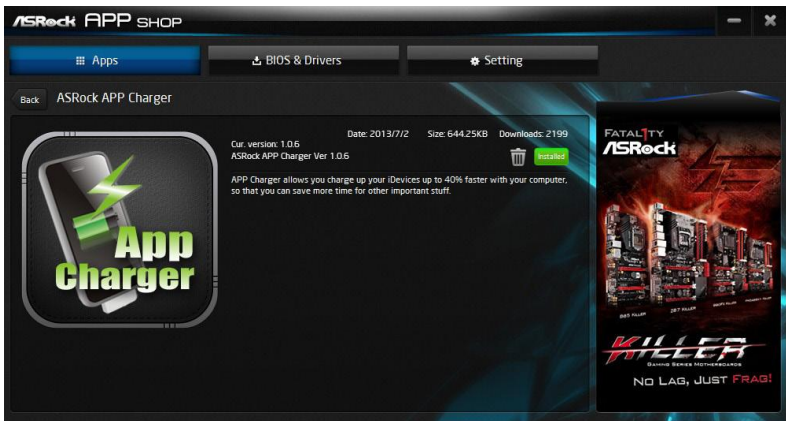

To uninstall it, simply click on the trash can icon .  
\*The trash icon may not appear for certain apps.

## Upgrading an App

You can only upgrade the apps you have already installed. When there is an available new version for your app, you will find the mark of "New Version" appears below the installed app icon.



### Step 1

Click on the app icon to see more details.

### Step 2

Click on the yellow icon  to start upgrading.

### 3.3.3 BIOS & Drivers

#### Installing BIOS or Drivers

When the "BIOS & Drivers" tab is selected, you will see a list of recommended or critical updates for the BIOS or drivers. Please update them all soon.

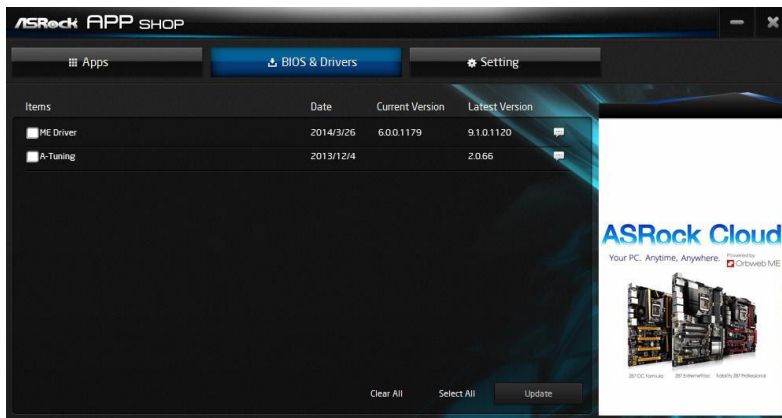

#### **Step 1**

Please check the item information before update. Click on ⓘ to see more details.

#### **Step 2**

Click to select one or more items you want to update.

#### **Step 3**

Click Update to start the update process.

### 3.3.4 Setting

In the "Setting" page, you can change the language, select the server location, and determine if you want to automatically run the ASRock Live Update & APP Shop on Windows startup.

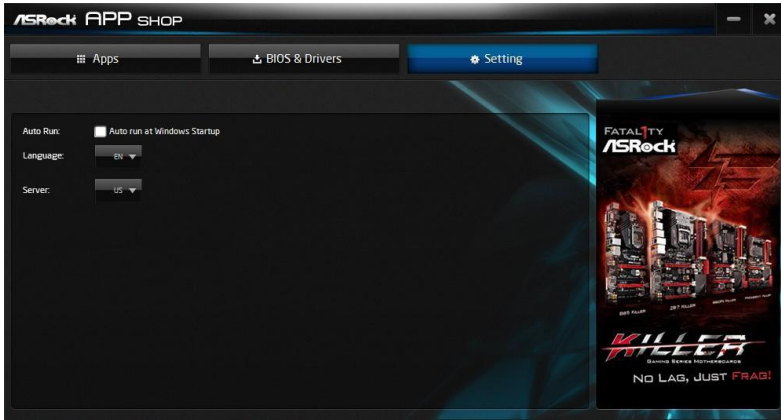

### 3.4 Nahimic Audio

Nahimic audio software provides an incredible high definition sound technology which boosts the audio and voice performance of your system. Nahimic Audio interface is composed of four tabs: Audio, Microphone, Sound Tracker and Settings.

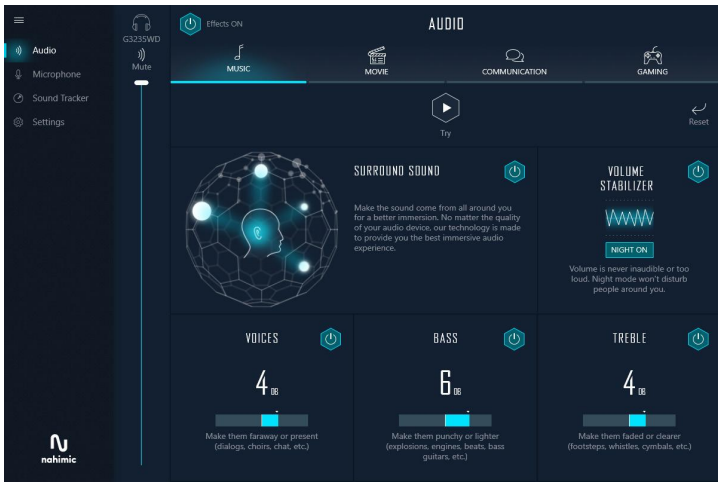

There are four functions in Nahimic audio :

No.	Function	Description
1	Audio	From this tab, you can mute the current audio device, choose between four factory audio profiles, turn all audio effects on/off, restores the current profile to its default settings and access Surround Sound and various features.
2	Microphone	From this tab, you can mute the current mic device, choose between two factory mic profiles, turn/off all microphone effects, restore the current profile to its default settings, and access Static Noise Suppression and various features.
3	Sound Tracker	The Sound Tracker provides a visual indication localizing the sources of the sounds while in a game. These are represented by dynamic segments pointing the direction of the sounds: the more opaque they are, the stronger the sounds are.
4	Settings	From this tab, you can access all settings and information of the software.

### 3.5 ASRock Polychrome SYNC

ASRock Polychrome SYNC is a lighting control utility specifically designed for unique individuals with sophisticated tastes to build their own stylish colorful lighting system. Simply by connecting the LED strip, you can customize various lighting schemes and patterns, including Static, Breathing, Strobe, Cycling, Music, Wave and more.

#### Connecting the LED Strip

Connect your RGB LED strips to the **RGB LED Headers (RGB\_LED1, RGB\_LED2)** on the motherboard.

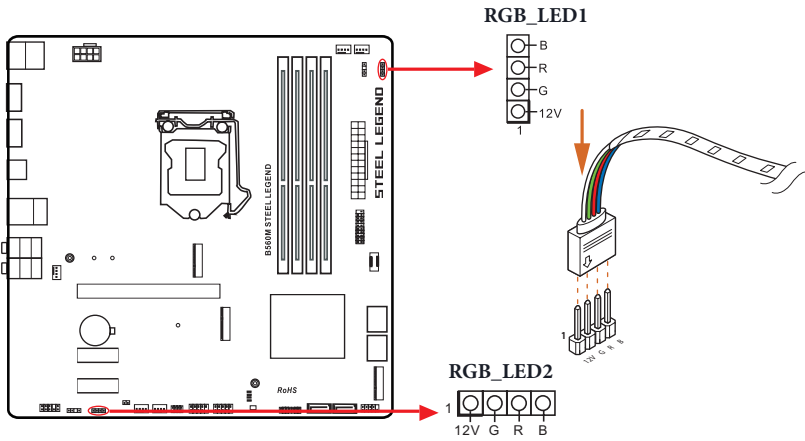

1. Never install the RGB LED cable in the wrong orientation; otherwise, the cable may be damaged.
2. Before installing or removing your RGB LED cable, please power off your system and unplug the power cord from the power supply. Failure to do so may cause damages to motherboard components.



1. Please note that the RGB LED strips do not come with the package.
2. The RGB LED header supports standard 5050 RGB LED strip (12V/G/R/B), with a maximum power rating of 3A (12V) and length within 2 meters.

## Connecting the Addressable RGB LED Strip

Connect your Addressable RGB LED strips to the **Addressable LED Headers (ADDR\_LED1, ADDR\_LED2)** on the motherboard.

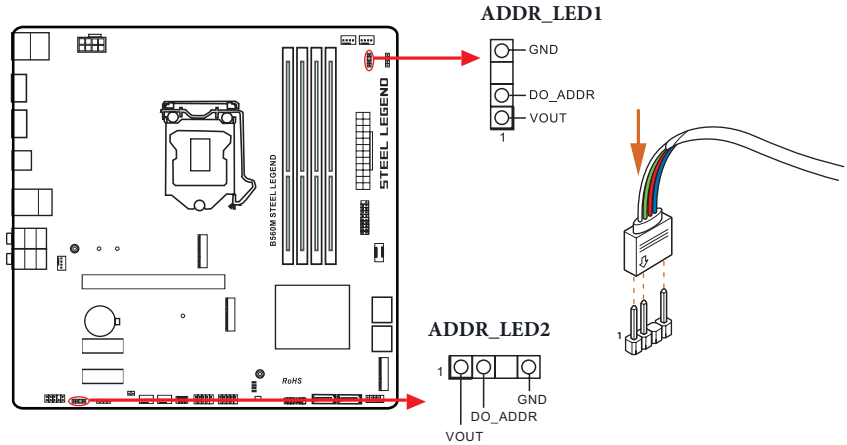

1. Never install the RGB LED cable in the wrong orientation; otherwise, the cable may be damaged.
2. Before installing or removing your RGB LED cable, please power off your system and unplug the power cord from the power supply. Failure to do so may cause damages to motherboard components.



1. Please note that the RGB LED strips do not come with the package.
2. The RGB LED header supports WS2812B addressable RGB LED strip (5V/Data/GND), with a maximum power rating of 3A (5V) and length within 2 meters.

## ASRock Polychrome SYNC Utility

Now you can adjust the RGB LED color through the ASRock Polychrome SYNC Utility. Download this utility from the ASRock Live Update & APP Shop and start coloring your PC style your way!

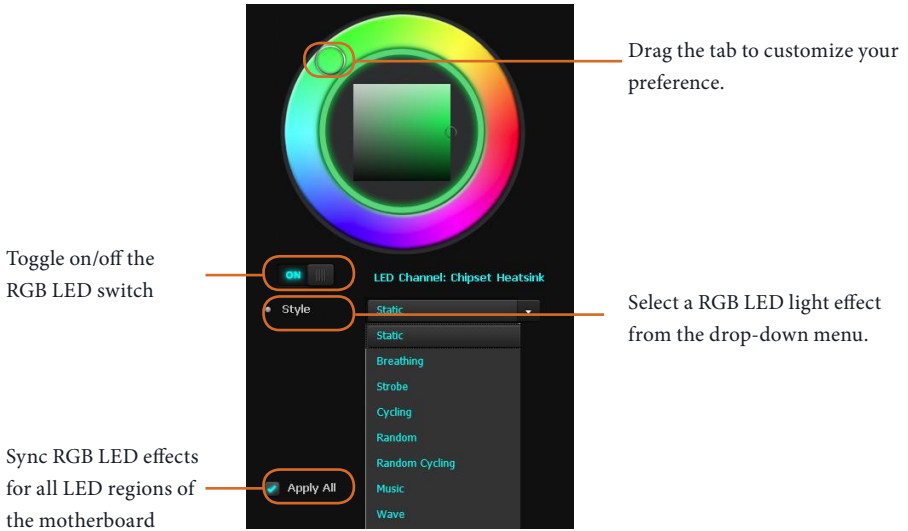



---

# Chapter 4 UEFI SETUP UTILITY

## 4.1 Introduction

This section explains how to use the UEFI SETUP UTILITY to configure your system. You may run the UEFI SETUP UTILITY by pressing <F2> or <Del> right after you power on the computer, otherwise, the Power-On-Self-Test (POST) will continue with its test routines. If you wish to enter the UEFI SETUP UTILITY after POST, restart the system by pressing <Ctl> + <Alt> + <Delete>, or by pressing the reset button on the system chassis. You may also restart by turning the system off and then back on.



*Because the UEFI software is constantly being updated, the following UEFI setup screens and descriptions are for reference purpose only, and they may not exactly match what you see on your screen.*

## 4.2 EZ Mode

The EZ Mode screen appears when you enter the BIOS setup program by default. EZ mode is a dashboard which contains multiple readings of the system's current status. You can check the most crucial information of your system, such as CPU speed, DRAM frequency, SATA information, fan speed, etc.

Press <F6> or click the "Advanced Mode" button at the upper right corner of the screen to switch to "Advanced Mode" for more options.

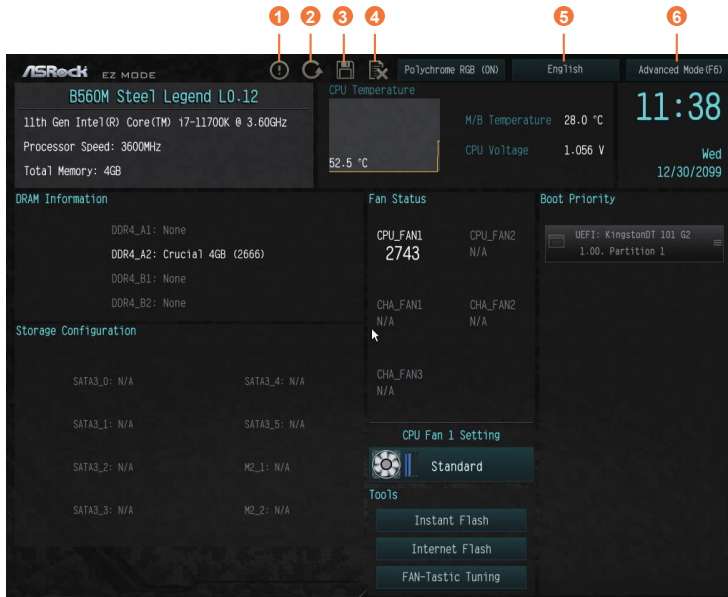

No.	Function
1	Help
2	Load UEFI Defaults
3	Save Changes and Exit
4	Discard Changes
5	Change Language
6	Switch to Advanced Mode

---

## 4.3 Advanced Mode

The Advanced Mode provides more options to configure the BIOS settings. Refer to the following sections for the detailed configurations.

To access the EZ Mode, press <F6> or click the "EZ Mode" button at the upper right corner of the screen.

### 4.3.1 UEFI Menu Bar

The top of the screen has a menu bar with the following selections:

<b>Main</b>	For setting system time/date information
<b>OC Tweaker</b>	For overclocking configurations
<b>Advanced</b>	For advanced system configurations
<b>Tool</b>	Useful tools
<b>H/W Monitor</b>	Displays current hardware status
<b>Security</b>	For security settings
<b>Boot</b>	For configuring boot settings and boot priority
<b>Exit</b>	Exit the current screen or the UEFI Setup Utility

### 4.3.2 Navigation Keys

Use <←> key or <→> key to choose among the selections on the menu bar, and use <↑> key or <↓> key to move the cursor up or down to select items, then press <Enter> to get into the sub screen. You can also use the mouse to click your required item.

Please check the following table for the descriptions of each navigation key.

Navigation Key(s)	Description
+ / -	To change option for the selected items
<Tab>	Switch to next function
<PGUP>	Go to the previous page
<PGDN>	Go to the next page
<HOME>	Go to the top of the screen
<END>	Go to the bottom of the screen
<F1>	To display the General Help Screen
<F5>	Add / Remove Favorite
<F7>	Discard changes and exit the SETUP UTILITY
<F9>	Load optimal default values for all the settings
<F10>	Save changes and exit the SETUP UTILITY
<F12>	Print screen
<ESC>	Jump to the Exit Screen or exit the current screen

## 4.4 Main Screen

When you enter the UEFI SETUP UTILITY, the Main screen will appear and display the system overview.



*The availability and location of BIOS settings can be different for different models and BIOS versions.*

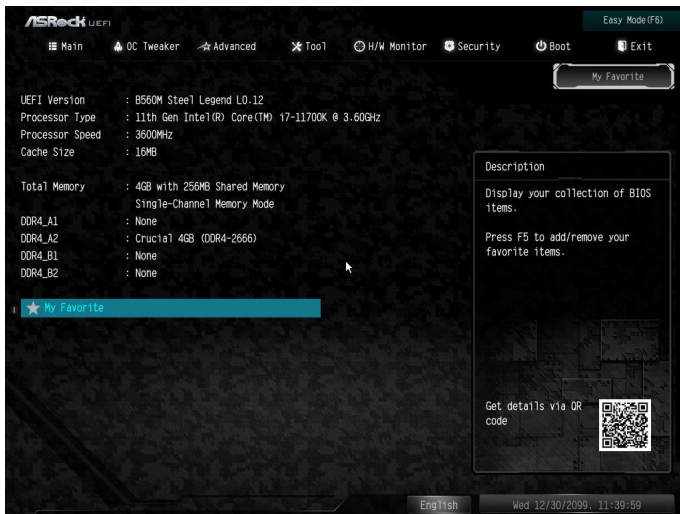

### My Favorite

Display your collection of BIOS items. Press F5 to add/remove your favorite items.

## 4.5 OC Tweaker Screen

In the OC Tweaker screen, you can set up overclocking features.



*Because the UEFI software is constantly being updated, the following UEFI setup screens and descriptions are for reference purpose only, and they may not exactly match what you see on your screen.*

### CPU Configuration

#### CPU Ratio

The CPU speed is determined by the CPU Ratio multiplied with the BCLK. Increasing the CPU Ratio will increase the internal CPU clock speed without affecting the clock speed of other components.

#### AVX2 Ratio Offset

AVX2 Ratio Offset specifies a negative offset from the CPU Ratio for AVX workloads. AVX is a more stressful workload that lower the AVX ratio to ensure maximum possible ratio for SSE workloads.

#### AVX-512 Ratio Offset

AVX-512 Ratio Offset specifies a negative offset from the CPU Ratio for AVX-512 workloads. AVX-512 is a more stressful workload that lower the AVX ratio to ensure

---

maximum possible ratio for SSE workloads.

### **CPU Cache Ratio**

The CPU Internal Bus Speed Ratio. The maximum should be the same as the CPU Ratio.

### **GT Frequency**

Configure the frequency of the integrated GPU.

### **BCLK Spread Spectrum Mode**

Enable Spread Spectrum to reduce electromagnetic interference for passing EMI tests. Disable to achieve higher clock speeds when overclocking.

### **BCLK Aware Adaptive Voltage**

BCLK Aware Adaptive Voltage enable/disable. When enabled, pcode will be aware of the BCLK frequency when calculating the CPU V/F curves. This is ideal for BCLK OC to avoid high voltage overrides.

### **Boot Performance Mode**

Select the performance state that the BIOS will set before OS handoff.

### **Ring to Core Ratio Offset**

Disable Ring to Core Ratio Offset so the ring and core can run at the same frequency.

### **Intel SpeedStep Technology**

Intel SpeedStep technology allows processors to switch between multiple frequencies and voltage points for better power saving and heat dissipation.

### **Intel Turbo Boost Technology**

Intel Turbo Boost Technology enables the processor to run above its base operating frequency when the operating system requests the highest performance state.

### **Intel Speed Shift Technology**

Enable/Disable Intel Speed Shift Technology support. Enabling will expose the CPPC v2 interface to allow for hardware controlled P-states.

### **Intel Turbo Boost Max Technology 3.0**

Intel Turbo Boost Technology enables the processor to run above its base operating frequency when the operating system requests the highest performance state.

## Intel Thermal Velocity Boost Voltage Optimizations

This service controls thermal based voltage optimizations for processors that implement the Intel Thermal Velocity Boost (TVB) feature.

## Dual Tau Boost

Enable Dual Tau Boost feature. This is only applicable for CMLS 35W/65W/125W skus. This item is only supported with processors with Config TDP support.

## Long Duration Power Limit

Configure Package Power Limit 1 in watts. When the limit is exceeded, the CPU ratio will be lowered after a period of time. A lower limit can protect the CPU and save power, while a higher limit may improve performance.

## Long Duration Maintained

Configure the period of time until the CPU ratio is lowered when the Long Duration Power Limit is exceeded.

## Short Duration Power Limit

Configure Package Power Limit 2 in watts. When the limit is exceeded, the CPU ratio will be lowered immediately. A lower limit can protect the CPU and save power, while a higher limit may improve performance.

## CPU Core Current Limit

Configure the current limit of the CPU core. A lower limit can protect the CPU and save power, while a higher limit may improve performance.

## System Agent Current Limit

Configure the current limit of the system agent. A lower limit can protect the CPU and save power, while a higher limit may improve performance.

## GT Current Limit

Configure the current limit of the GT slice. A lower limit can protect the CPU and save power, while a higher limit may improve performance.

## DRAM Configuration

### Memory Information

Allows users to browse the serial presence detect (SPD) and Intel extreme memory profile (XMP) for DDR4 modules.

### DRAM Timing Configuration



## Load XMP Setting

Load XMP settings to overclock the memory and perform beyond standard specifications.

## DRAM Reference Clock

Select Auto for optimized settings.

## DRAM Frequency

If [Auto] is selected, the motherboard will detect the memory module(s) inserted and assign the appropriate frequency automatically.

## DRAM Gear Mode

Gear2 mode doubled the ratio in memory controller, and it is good for high frequency.

## System Agent Geyserville

Configure System Agent Geyserville (SA GV) settings.

## Primary Timing

### CAS# Latency (tCL)

The time between sending a column address to the memory and the beginning of the data in response.

### RAS# to CAS# Delay and Row Precharge (tRCDtRP)

RAS# to CAS# Delay : The number of clock cycles required between the opening of a row of memory and accessing columns within it.

Row Precharge: The number of clock cycles required between the issuing of the precharge command and opening the next row.

### RAS# Active Time (tRAS)

The number of clock cycles required between a bank active command and issuing the precharge command.

### Command Rate (CR)

The delay between when a memory chip is selected and when the first active command can be issued.

## Secondary Timing

### Write Recovery Time (tWR)

The amount of delay that must elapse after the completion of a valid write operation, before an active bank can be precharged.

### Refresh Cycle Time (tRFC)

The number of clocks from a Refresh command until the first Activate command to the same rank.

### RAS to RAS Delay (tRRD\_L)

The number of clocks between two rows activated in different banks of the same rank.

### RAS to RAS Delay (tRRD\_S)

The number of clocks between two rows activated in different banks of the same rank.

### Write to Read Delay (tWTR\_L)

The number of clocks between the last valid write operation and the next read command to the same internal bank.

### Write to Read Delay (tWTR\_S)

The number of clocks between the last valid write operation and the next read command to the same internal bank.

### Read to Precharge (tRTP)

The number of clocks that are inserted between a read command to a row precharge command to the same rank.

### Four Activate Window (tFAW)

The time window in which four activates are allowed the same rank.

### CAS Write Latency (tCWL)

Configure CAS Write Latency.

## Third Timing

### tREFI

Configure refresh cycles at an average periodic interval.

### tCKE

Configure the period of time the DDR4 initiates a minimum of one refresh command internally once it enters Self-Refresh mode.

---

## Turn Around Timing

### Turn Around Timing Optimization

Auto is enabled in general case.

#### tRDRD\_sg

Configure between module read to read delay.

#### tRDRD\_dg

Configure between module read to read delay.

#### tRDRD\_dr

Configure between module read to read delay.

#### tRDRD\_dd

Configure between module read to read delay.

#### tRDWR\_sg

Configure between module read to write delay.

#### tRDWR\_dg

Configure between module read to write delay.

#### tRDWR\_dr

Configure between module read to write delay.

#### tRDWR\_dd

Configure between module read to write delay.

#### tWRRD\_sg

Configure between module write to read delay.

#### tWRRD\_dg

Configure between module write to read delay.

#### tWRRD\_dr

Configure between module write to read delay.

#### tWRRD\_dd

Configure between module write to read delay.

**tWRWR\_sg**

Configure between module write to write delay.

**tWRWR\_dg**

Configure between module write to write delay.

**tWRWR\_dr**

Configure between module write to write delay.

**tWRWR\_dd**

Configure between module write to write delay.

**Round Trip Timing****Round Trip Timing Optimization**

Auto is enabled in general case.

**Rx FiFO Delay Offset**

Configure Rx FiFO Delay Offset.

**Initial RTL (A1 Rank1)**

Configure round trip latency initial value.

**Initial RTL (A1 Rank2)**

Configure round trip latency initial value.

**Initial RTL (A2 Rank1)**

Configure round trip latency initial value.

**Initial RTL (A2 Rank2)**

Configure round trip latency initial value.

**Initial RTL (B1 Rank1)**

Configure round trip latency initial value.

**Initial RTL (B1 Rank2)**

Configure round trip latency initial value.

**Initial RTL (B2 Rank1)**

Configure round trip latency initial value.

### Initial RTL (B2 Rank2)

Configure round trip latency initial value.

### RTL (A1 Rank1)

Configure round trip latency.

### RTL (A1 Rank2)

Configure round trip latency.

### RTL (A2 Rank1)

Configure round trip latency.

### RTL (A2 Rank2)

Configure round trip latency.

### RTL (B1 Rank1)

Configure round trip latency.

### RTL (B1 Rank2)

Configure round trip latency.

### RTL (B2 Rank1)

Configure round trip latency.

### RTL (B2 Rank2)

Configure round trip latency.

## ODT Setting

### ODT WR (A1)

Configure the memory on die termination resistors' WR for channel A1.

### ODT WR (A2)

Configure the memory on die termination resistors' WR for channel A2.

### ODT WR (B1)

Configure the memory on die termination resistors' WR for channel B1.

### ODT WR (B2)

Configure the memory on die termination resistors' WR for channel B2.

**ODT NOM (A1)**

Use this to change ODT (CH A1) Auto/Manual settings. The default is [Auto].

**ODT NOM (A2)**

Use this to change ODT (CH A2) Auto/Manual settings. The default is [Auto].

**ODT NOM (B1)**

Use this to change ODT (CH B1) Auto/Manual settings. The default is [Auto].

**ODT NOM (B2)**

Use this to change ODT (CH B2) Auto/Manual settings. The default is [Auto].

**ODT PARK (A1)**

Configure the memory on die termination resistors' PARK for channel A1.

**ODT PARK (A2)**

Configure the memory on die termination resistors' PARK for channel A2.

**ODT PARK (B1)**

Configure the memory on die termination resistors' PARK for channel B1.

**ODT PARK (B2)**

Configure the memory on die termination resistors' PARK for channel B2.

**Advanced Setting****ASRock Timing Optimization**

Configure the fast path through the MRC.

**ASRock Second Timing Optimization**

Configure the second fast path through the MRC.

**Memory Training Mode**

Configure the Training Memory Mode.

**Realtime Memory Timing**

Configure the realtime memory timings.

[Enabled] The system will allow performing realtime memory timing changes after MRC\_DONE.

---

## Reset for MRC Failed

Reset system after MRC training is failed.

## Train on Warm Boot

When enabled, memory training will be executed when warm boot.

## MRC Fast Boot

Enable Memory Fast Boot to skip DRAM memory training for booting faster.

## Voltage Configuration

### Voltage Mode

[OC]: Larger range voltage for overclocking.

[STABLE]: Smaller range voltage for stable system.

### CPU Core/Cache Voltage

Input voltage for the processor by the external voltage regulator.

### CPU Core/Cache Load-Line Calibration

CPU Core/Cache Load-Line Calibration helps prevent CPU Core/Cache voltage droop when the system is under heavy loading.

### CPU GT Voltage

Configure the voltage for the integrated GPU.

### CPU GT Load-Line Calibration

GT Load-Line Calibration helps prevent integrated GPU voltage droop when the system is under heavy load.

### VCCSA Voltage

Configure the voltage for the VCCSA.

### DRAM Voltage

Use this to configure DRAM Voltage. The default value is [Auto].

### VCCIO Voltage

Configure the voltage for the VCCIO.

### VCCIO 1 2 Voltage

Configure the voltage for the VCCIO 1 2.

## DRAM Activating Power Supply

Configure the voltage for the DRAM Activating Power Supply.

## VCCIN AUX Voltage

Configure the voltage for the VCCIN AUX.

## CPU Standby Voltage

Configure the voltage for the CPU Standby.

## PLL Voltage Configuration

### CPU Internal PLL Voltage

Default is 0.900V. Each step is 0.0175V. Adding 9~15 steps will help CPU PLL to lock internal clock during High frequency under Ln2 cooling. For Example: 1.0575V ~ 1.1625V will be proper value. But the voltage level will be different on each processor. User has to find the best value for your own processor. VCCPLL Voltage must be at least 150mV higher than the target PLL voltage, or your system will hang.

### GT PLL Voltage

Default is 0.900V. Each step is 0.0175V. Adding 9~15 steps will help CPU PLL to lock internal clock during High frequency under Ln2 cooling. For Example: 1.0575V ~ 1.1625V will be proper value. But the voltage level will be different on each processor. User has to find the best value for your own processor. VCCPLL Voltage must be at least 150mV higher than the target PLL voltage, or your system will hang.

### Ring PLL Voltage

Default is 0.900V. Each step is 0.0175V. Adding 9~15 steps will help CPU PLL to lock internal clock during High frequency under Ln2 cooling. For Example: 1.0575V ~ 1.1625V will be proper value. But the voltage level will be different on each processor. User has to find the best value for your own processor. VCCPLL Voltage must be at least 150mV higher than the target PLL voltage, or your system will hang.

### System Agent PLL Voltage

Default is 0.900V. Each step is 0.0175V. Adding 9~15 steps will help CPU PLL to lock internal clock during High frequency under Ln2 cooling. For Example: 1.0575V ~ 1.1625V will be proper value. But the voltage level will be different on each processor. User has to find the best value for your own processor. VCCPLL Voltage must be at least 150mV higher than the target PLL voltage, or your system will hang.

### Memory Controller PLL Voltage

Default is 0.900V. Each step is 0.0175V. Adding 9~15 steps will help CPU PLL to



---

lock internal clock during High frequency under Ln2 cooling. For Example: 1.0575V ~ 1.1625V will be proper value. But the voltage level will be different on each processor. User has to find the best value for your own processor. VCCPLL Voltage must be at least 150mV higher than the target PLL voltage, or your system will hang.

## AVX Configuration

### AVX2 Voltage Guardband Scale Factor

AVX2 Voltage Guardband Scale Factor controls the voltage guardband applied to AVX2 workloads. A value > 1.00 will increase the voltage guardband, and < 1.00 will decrease the voltage guardband.

### AVX-512 Voltage Guardband Scale Factor

AVX-512 Voltage Guardband Scale Factor controls the voltage guardband applied to AVX-512 workloads. A value > 1.00 will increase the voltage guardband, and < 1.00 will decrease the voltage guardband.

### Save User Default

Type a profile name and press enter to save your settings as user default.

### Load User Default

Load previously saved user defaults.

### Save User UEFI Setup Profile to Disk

It helps you to save current UEFI settings as an user profile to disk.

### Load User UEFI Setup Profile from Disk

You can load previous saved profile from the disk.

## 4.6 Advanced Screen

In this section, you may set the configurations for the following items: CPU Configuration, Chipset Configuration, Storage Configuration, Super IO Configuration, ACPI Configuration, USB Configuration and Trusted Computing.



*Setting wrong values in this section may cause the system to malfunction.*

### UEFI Configuration

#### UEFI Setup Style

Select the default mode when entering the UEFI setup utility.

#### Active Page on Entry

Select the default page when entering the UEFI setup utility.

#### Full HD UEFI

When [Auto] is selected, the resolution will be set to 1920 x 1080 if the monitor supports Full HD resolution. If the monitor does not support Full HD resolution, then the resolution will be set to 1024 x 768. When [Disable] is selected, the resolution will be set to 1024 x 768 directly.

## 4.6.1 CPU Configuration



### Intel Hyper Threading Technology

Intel Hyper Threading Technology allows multiple threads to run on each core, so that the overall performance on threaded software is improved.

### Active Processor Cores

Select the number of cores to enable in each processor package.

### CPU C States Support

Enable CPU C States Support for power saving. It is recommended to keep C6 and C7 all enabled for better power saving.

### Enhanced Halt State (C1E)

Enable Enhanced Halt State (C1E) for lower power consumption.

### CPU C6 State Support

Enable C6 deep sleep state for lower power consumption.

### CPU C7 State Support

Enable C7 deep sleep state for lower power consumption.

### Package C State Support

Enable CPU, PCIe, Memory, Graphics C State Support for power saving.

## CFG Lock

This item allows you to disable or enable the CFG Lock.

## C6DRAM

Enable/Disable moving of DRAM contents to PRM memory when CPU is in C6 state.

## CPU Thermal Throttling

Enable CPU internal thermal control mechanisms to keep the CPU from overheating.

## Intel AVX/AVX2

Enable/Disable the Intel AVX and AVX2 Instructions. This is applicable for Big Core only.

## Intel AVX-512

Enable/Disable the Intel AVX-512 (a.k.a. AVX3) Instructions. This is applicable for Big Core only.

## Intel Virtualization Technology

Intel Virtualization Technology allows a platform to run multiple operating systems and applications in independent partitions, so that one computer system can function as multiple virtual systems.

## Hardware Prefetcher

Automatically prefetch data and code for the processor. Enable for better performance.

## Adjacent Cache Line Prefetch

Automatically prefetch the subsequent cache line while retrieving the currently requested cache line. Enable for better performance.

## 4.6.2 Chipset Configuration



### Primary Graphics Adapter

Select a primary VGA.

### Above 4G Decoding

Enable or disable 64bit capable Devices to be decoded in Above 4G Address Space (only if the system supports 64 bit PCI decoding).

### VT-d

Intel® Virtualization Technology for Directed I/O helps your virtual machine monitor better utilize hardware by improving application compatibility and reliability, and providing additional levels of manageability, security, isolation, and I/O performance.

### SR-IOV Support

If system has SR-IOV capable PCIe Devices, this option Enables or Disables Single Root IO Virtualization Support.

### DMI Link Speed

Configure DMI Slot Link Speed. Auto mode is optimizing for overclocking.

### PCIe1 Link Speed

Select the link speed for PCIe1.

### PCIe2 Link Speed

Select the link speed for PCIe2.

### PCIe3 Link Speed

Select the link speed for PCIe3.

### PCI Express Native Control

Select Enable for enhanced PCI Express power saving in OS.

### PCIe ASPM Support

This option enables/disables the ASPM support for all CPU downstream devices.

### PCH PCIe ASPM Support

This option enables/disables the ASPM support for all PCH PCIe devices.

### DMI ASPM Support

This option enables/disables the control of ASPM on CPU side of the DMI Link.

### PCH DMI ASPM Support

This option enables/disables the ASPM support for all PCH DMI devices.

### Share Memory

Configure the size of memory that is allocated to the integrated graphics processor when the system boots up.

### IGPU Multi-Monitor

Select disable to disable the integrated graphics when an external graphics card is installed.  
Select enable to keep the integrated graphics enabled at all times.

### Inte(R) Ethernet Connection I219-V

Enable or disable the onboard network interface controller (Intel® I219V).

### Realtek 2.5G Ethernet Controller

Enable or disable the onboard network interface controller (Dragon RTL8125BG).

### Onboard HD Audio

Enable/disable onboard HD audio. Set to Auto to enable onboard HD audio and automatically disable it when a sound card is installed.

### Front Panel

---

Enable/disable front panel HD audio.

### **Onboard HDMI HD Audio**

Enable audio for the onboard digital outputs.

### **Onboard WAN Device**

Use this item to enable or disable the onboard WAN device.

### **WAN Radio**

Enable/disable the WiFi module's connectivity.

### **Bluetooth**

Enable/disable the Bluetooth connectivity.

### **Deep Sleep**

Configure deep sleep mode for power saving when the computer is shut down.

### **Restore on AC/Power Loss**

Select the power state after a power failure. If [Power Off] is selected, the power will remain off when the power recovers. If [Power On] is selected, the system will start to boot up when the power recovers.

### **Turn On Onboard LED in S5**

Turn on Onboard LED in the ACPI S5 state.

### **Restore Onboard LED Default**

Restore Onboard LED default value.

### **RGB LED**

This option enables/disables the RGB LED.

## 4.6.3 Storage Configuration



### SATA Controller(s)

Enable/disable the SATA controllers.

### SATA Mode Selection

AHCI: Supports new features that improve performance.

### SATA Aggressive Link Power Management

SATA Aggressive Link Power Management allows SATA devices to enter a low power state during periods of inactivity to save power. It is only supported by AHCI mode.

### Hard Disk S.M.A.R.T.

S.M.A.R.T stands for Self-Monitoring, Analysis, and Reporting Technology. It is a monitoring system for computer hard disk drives to detect and report on various indicators of reliability.



## 4.6.4 Super IO Configuration

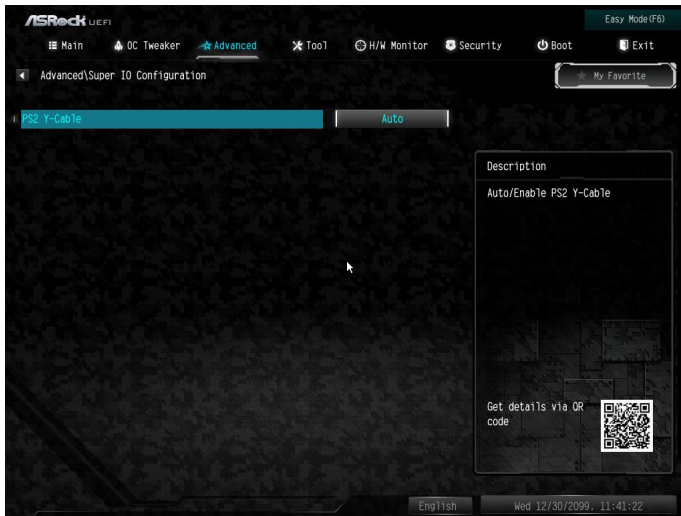

### PS2 Y-Cable

Enable the PS2 Y-Cable or set this option to Auto.

## 4.6.5 ACPI Configuration



### Suspend to RAM

Select disable for ACPI suspend type S1. It is recommended to select auto for ACPI S3 power saving.

### PS/2 Keyboard S4/S5 Wakeup Support

Allow the system to be waked up by a PS/2 Keyboard in S4/S5.

### PCIE Devices Power On

Allow the system to be waked up by a PCIE device and enable wake on LAN.

### I219 LAN Power On

Allow the system to be waked up by the Onboard Intel LAN.

### RTC Alarm Power On

Allow the system to be waked up by the real time clock alarm. Set it to By OS to let it be handled by your operating system.

### USB Keyboard/Remote Power On

Allow the system to be waked up by an USB keyboard or remote controller.

### USB Mouse Power On

Allow the system to be waked up by an USB mouse.

## 4.6.6 USB Configuration

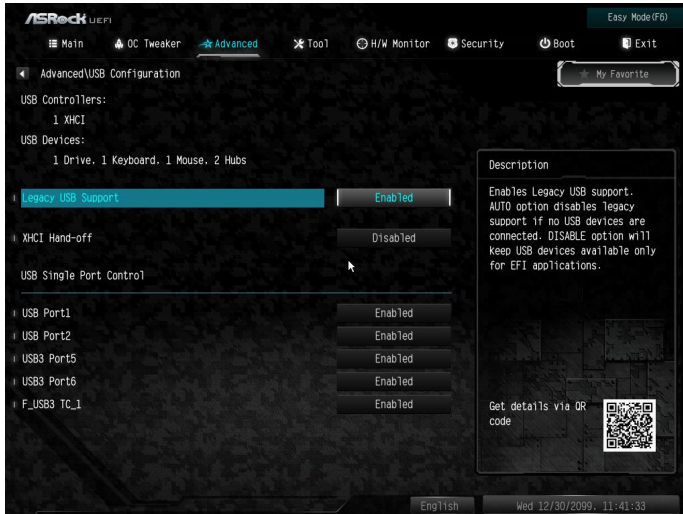

### Legacy USB Support

Enable or disable Legacy OS Support for USB 2.0 devices. If you encounter USB compatibility issues it is recommended to disable legacy USB support. Select UEFI Setup Only to support USB devices under the UEFI setup and Windows/Linux operating systems only.

### XHCI Hand-off

This is a workaround for OSes without XHCI hand-off support. The XHCI ownership change should be claimed by XHCI driver.

## 4.6.7 Trusted Computing

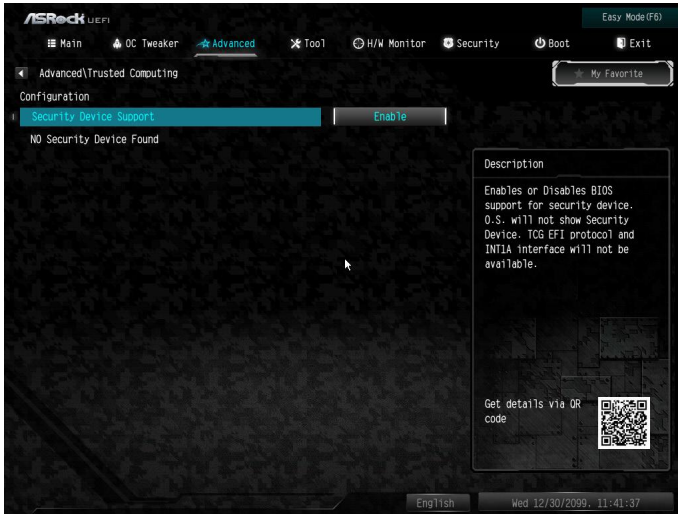

### Security Device Support

Enable or disable BIOS support for security device.

## 4.7 Tools



### ASRock Polychrome RGB

Select LED lighting color.

### UEFI Tech Service

Contact ASRock Tech Service if you are having trouble with your PC. Please setup network configuration before using UEFI Tech Service.

### SSD Secure Erase Tool

All the SSD's listed that supports Secure Erase function.

### NVME Sanitization Tool

After you Sanitize SSD, all user data will be permanently destroyed on the SSD and cannot be recovered.

### Instant Flash

Save UEFI files in your USB storage device and run Instant Flash to update your UEFI.

### Internet Flash - DHCP (Auto IP), Auto

ASRock Internet Flash downloads and updates the latest UEFI firmware version from our servers for you. Please setup network configuration before using Internet

Flash.

\*For BIOS backup and recovery purpose, it is recommended to plug in your USB pen drive before using this function.

## Network Configuration

Use this to configure internet connection settings for Internet Flash.

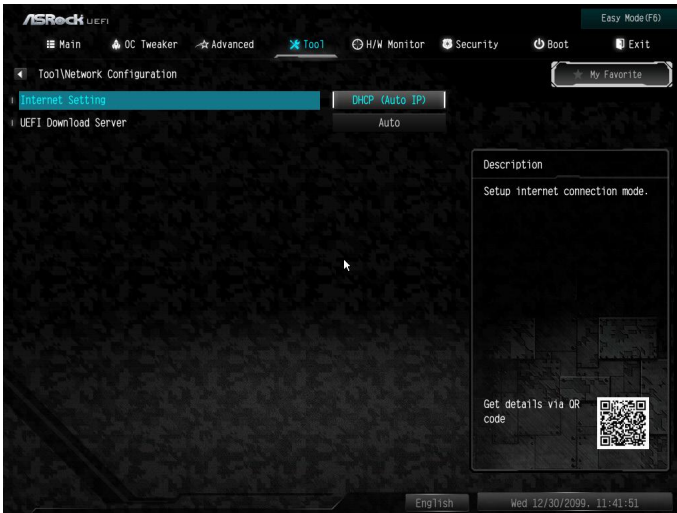

### Internet Setting

Enable or disable sound effects in the setup utility.

### UEFI Download Server

Select a server to download the UEFI firmware.

## 4.8 Hardware Health Event Monitoring Screen

This section allows you to monitor the status of the hardware on your system, including the parameters of the CPU temperature, motherboard temperature, fan speed and voltage.



### Fan Tuning

Measure Fan Min Duty Cycle.

### Fan-Tastic Tuning

Select a fan mode for CPU Fan, or choose Customize to set 5 CPU temperatures and assign a respective fan speed for each temperature.

### CPU Fan 1 Setting

Select a fan mode for CPU Fan 1, or choose Customize to set 5 CPU temperatures and assign a respective fan speed for each temperature.

### CPU Fan 1 Step Up

Set the value of CPU Fan 1 Step Up.

### CPU Fan 1 Step Down

Set the value of CPU Fan 1 Step Down.

### CPU\_FAN2 / W\_PUMP Switch

Switch CPU\_FAN2 / W\_PUMP header function.

## CPU Fan 2 Control Mode

Select DC/PWM mode for CPU Fan 2.

## CPU Fan 2 Setting

Select a fan mode for CPU Fan 2, or choose Customize to set 5 CPU temperatures and assign a respective fan speed for each temperature.

## CPU Fan 2 Temp Source

Select a fan temperature source for CPU Fan 2.

## CPU Fan 2 Step Up

Set the value of CPU Fan 2 Step Up.

## CPU Fan 2 Step Down

Set the value of CPU Fan 2 Step Down.

## CHA\_FAN1 / W\_PUMP Switch

Select Chassis Fan 1 or Water Pump mode.

## Chassis Fan 1 Control Mode

Select PWM mode or DC mode for Chassis Fan 1.

## Chassis Fan 1 Setting

Select a fan mode for Chassis Fan 1, or choose Customize to set 5 CPU temperatures and assign a respective fan speed for each temperature.

## Chassis Fan 1 Temp Source

Select a fan temperature source for Chassis Fan 1.

## Chassis Fan 1 Step Up

Set the value of Chassis Fan 1 Step Up.

## Chassis Fan 1 Step Down

Set the value of Chassis Fan 1 Step Down.

## CHA\_FAN2 / W\_PUMP Switch

Select Chassis Fan 2 or Water Pump mode.

## Chassis Fan 2 Control Mode

Select PWM mode or DC mode for Chassis Fan 2.



---

## Chassis Fan 2 Setting

Select a fan mode for Chassis Fan 2, or choose Customize to set 5 CPU temperatures and assign a respective fan speed for each temperature.

## Chassis Fan 2 Temp Source

Select a fan temperature source for Chassis Fan 2.

## Chassis Fan 2 Step Up

Set the value of Chassis Fan 2 Step Up.

## Chassis Fan 2 Step Down

Set the value of Chassis Fan 2 Step Down.

## CHA\_FAN3 / W\_PUMP Switch

Select Chassis Fan 3 or Water Pump mode.

## Chassis Fan 3 Control Mode

Select PWM mode or DC mode for Chassis Fan 3.

## Chassis Fan 3 Setting

Select a fan mode for Chassis Fan 3, or choose Customize to set 5 CPU temperatures and assign a respective fan speed for each temperature.

## Chassis Fan 3 Temp Source

Select a fan temperature source for Chassis Fan 3.

## Chassis Fan 3 Step Up

Set the value of Chassis Fan 3 Step Up.

## Chassis Fan 3 Step Down

Set the value of Chassis Fan 3 Step Down.

## Case Open Feature

Enable or disable Case Open Feature to detect whether the chassis cover has been removed.

## 4.9 Security Screen

In this section you may set or change the supervisor/user password for the system. You may also clear the user password.

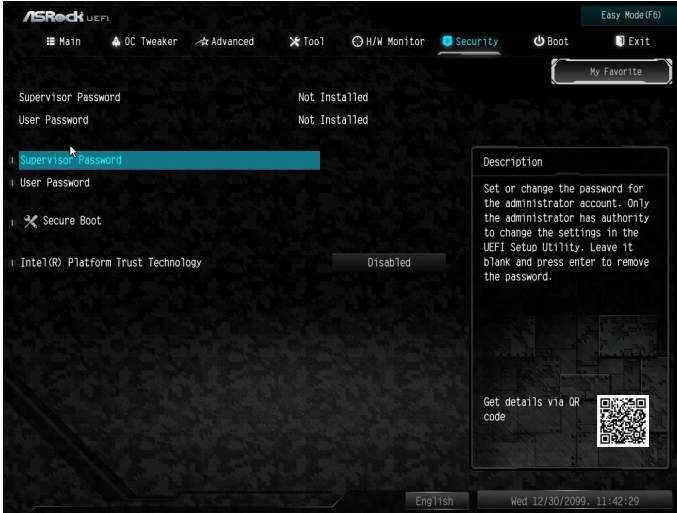

### Supervisor Password

Set or change the password for the administrator account. Only the administrator has authority to change the settings in the UEFI Setup Utility. Leave it blank and press enter to remove the password.

### User Password

Set or change the password for the user account. Users are unable to change the settings in the UEFI Setup Utility. Leave it blank and press enter to remove the password.

### Secure Boot

Use this item to enable or disable support for Secure Boot.

### Intel(R) Platform Trust Technology

Enable/disable Intel PTT in ME. Disable this option to use discrete TPM Module.

## 4.10 Boot Screen

This section displays the available devices on your system for you to configure the boot settings and the boot priority.



### Fast Boot

Fast Boot minimizes your computer's boot time. In fast mode you may not boot from an USB storage device. The VBIOS must support UEFI GOP if you are using an external graphics card. Please notice that Ultra Fast mode will boot so fast that the only way to enter this UEFI Setup Utility is to Clear CMOS or run the Restart to UEFI utility in Windows.

### Boot From Onboard LAN

Allow the system to be waked up by the onboard LAN.

### Setup Prompt Timeout

Configure the number of seconds to wait for the setup hot key.

### Bootup Num-Lock

Select whether Num Lock should be turned on or off when the system boots up.

### Boot Beep

Select whether the Boot Beep should be turned on or off when the system boots up. Please note that a buzzer is needed.

## Full Screen Logo

Enable to display the boot logo or disable to show normal POST messages.

## AddOn ROM Display

Enable AddOn ROM Display to see the AddOn ROM messages or configure the AddOn ROM if you've enabled Full Screen Logo. Disable for faster boot speed.

## Boot Failure Guard Message

If the computer fails to boot for a number of times the system automatically restores the default settings.

## CSM (Compatibility Support Module)

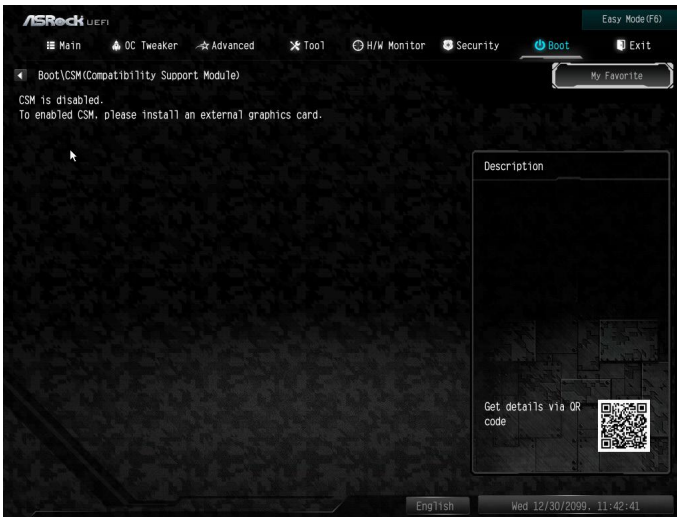

## CSM

Enable to launch the Compatibility Support Module. Please do not disable unless you're running a WHCK test.

## Launch PXE OpROM Policy

Select UEFI only to run those that support UEFI option ROM only. Select Legacy only to run those that support legacy option ROM only. Select Do not launch to not execute both legacy and UEFI option ROM.

## Launch Storage OpROM Policy

---

Select UEFI only to run those that support UEFI option ROM only. Select Legacy only to run those that support legacy option ROM only. Select Do not launch to not execute both legacy and UEFI option ROM.

### Other PCI Device ROM Priority

For PCI devices other than Network, Mass storage or Video defines which OpROM to launch.

## 4.11 Exit Screen

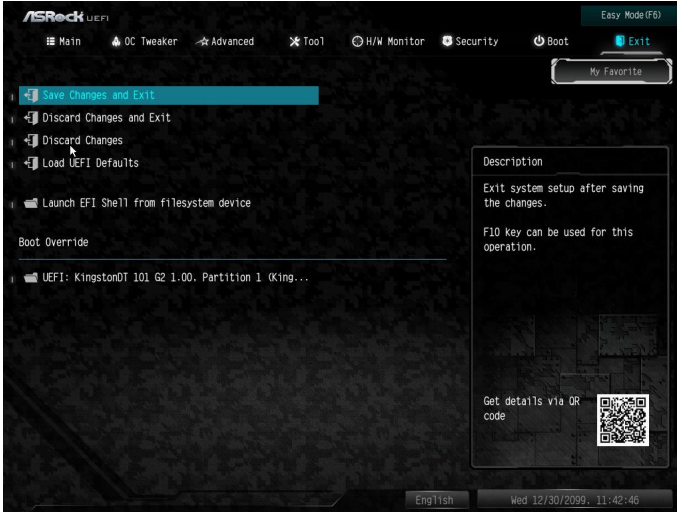

### Save Changes and Exit

When you select this option the following message, “Save configuration changes and exit setup?” will pop out. Select [OK] to save changes and exit the UEFI SETUP UTILITY.

### Discard Changes and Exit

When you select this option the following message, “Discard changes and exit setup?” will pop out. Select [OK] to exit the UEFI SETUP UTILITY without saving any changes.

### Discard Changes

When you select this option the following message, “Discard changes?” will pop out. Select [OK] to discard all changes.

### Load UEFI Defaults

Load UEFI default values for all options. The F9 key can be used for this operation.

### Launch EFI Shell from filesystem device

Copy shellx64.efi to the root directory to launch EFI Shell.

## Contact Information

If you need to contact ASRock or want to know more about ASRock, you're welcome to visit ASRock's website at <http://www.asrock.com>; or you may contact your dealer for further information. For technical questions, please submit a support request form at <http://www.asrock.com/support/tsd.asp>

### **ASRock Incorporation**

2F., No.37, Sec. 2, Jhongyang S. Rd., Beitou District,

Taipei City 112, Taiwan (R.O.C.)

### **ASRock EUROPE B.V.**

Bijsterhuizen 11-11

6546 AR Nijmegen

The Netherlands

Phone: +31-24-345-44-33

Fax: +31-24-345-44-38

### **ASRock America, Inc.**

13848 Magnolia Ave, Chino, CA91710

U.S.A.

Phone: +1-909-590-8308

Fax: +1-909-590-1026

# DECLARATION OF CONFORMITY

Per FCC Part 2 Section 2.1077(a)



**Responsible Party Name:** ASRock Incorporation

**Address:** 13848 Magnolia Ave, Chino, CA91710

**Phone/Fax No:** +1-909-590-8308/+1-909-590-1026

hereby declares that the product

**Product Name :** Motherboard

**Model Number :** B560M Steel Legend

Conforms to the following specifications:

FCC Part 15, Subpart B, Unintentional Radiators

## **Supplementary Information:**

This device complies with part 15 of the FCC Rules. Operation is subject to the following two conditions: (1) This device may not cause harmful interference, and (2) this device must accept any interference received, including interference that may cause undesired operation.

Representative Person's Name: James

Signature:

A handwritten signature in black ink, appearing to read 'James', written over a horizontal line.

Date : May 12, 2017



# EU Declaration of Conformity



For the following equipment:

**Motherboard**

(Product Name)

**B560M Steel Legend / ASRock**

(Model Designation / Trade Name)

**ASRock Incorporation**

(Manufacturer Name)

**2F., No.37, Sec. 2, Jhongyang S. Rd., Beitou District, Taipei City 112, Taiwan (R.O.C.)**

(Manufacturer Address)

**EMC — Directive 2014/30/EU (from April 20th, 2016)**

EN 55022:2010/AC:2011 Class B

EN 55024:2010/A1:2015

EN 55032:2012+AC:2013 Class B

EN 61000-3-3:2013

EN 61000-3-2:2014

**LVD — Directive 2014/35/EU (from April 20th, 2016)**

EN 60950-1 : 2011+ A2: 2013

EN 60950-1 : 2006/A12: 2011

**RoHS — Directive 2011/65/EU**

CE marking

(EU conformity marking)



**ASRock EUROPE B.V.**

(Company Name)

**Bijsterhuizen 1111 6546 AR Nijmegen The Netherlands**

(Company Address)

Person responsible for making this declaration:

(Name, Surname)

**A.V.P**

(Position / Title)

**February 5, 2021**

(Date)

P/N: 15G062267000AK V1.0