



Wood Trick[®]
A NEW WORLD OF ART

RU Внимание! **UKR** Увага! **ENG** Attention! **DEU** Achtung! **FRA** Attention! **POL** Uwaga! **SPA** Atención! **ITA** Attenzione! **TUR** Dikkat!



RU Не поджигать! **UKR** Не підпалювати! **ENG** Do not set fire to it! **DEU** Nicht anzünden! **FRA** Ne pas allumer! **POL** Nie zapalać! **SPA** No prender fuego! **ITA** Non accendere! **TUR** Yakmayın!



RU Осторожно! Острые детали! **UKR** Обережно! Гострі деталі! **ENG** Caution! Sharp parts! **DEU** Vorsicht! Scharfe Bauelemente! **FRA** Attention! Détails piquants! **POL** Uwaga! Ostre części! **SPA** Cuidado! Piezas cortantes! **ITA** Attenzione! Dettagli appuntiti! **TUR** Dikkat! Keskin parçalar!

RU Рекомендация: если возникли сложности при скреплении деталей, обработайте зубчистки парафином. **UKR** Рекомендація: якщо виникли складнощі при скріпленні деталей, обробіть зубчистки парафіном. **ENG** Recommendations: If there are difficulties in connecting the parts, treat the toothpicks with paraffin wax. **DEU** Empfehlung: Wenn Sie Schwierigkeiten bei der Verknüpfung der Bauelemente haben, bearbeiten Sie die Stocher mit dem Paraffin. **FRA** Conseil: Si vous avez du mal à assembler les détails, traitez les cure-dents avec de la paraffine. **POL** Zalecenie: Jeśli występują trudności w połączeniu części, obrób wykałaczki parafiną. **SPA** Recomendación: Si surgen dificultades para fijar piezas, trate mondadientes con parafina. **ITA** Raccomandazione: nel caso di difficoltà nel collegamento dei dettagli si consiglia di trattare gli stecchini con paraffina. **TUR** Öneriler: Parça sabitlemesi sırasında sorunlarla karşılaşmanız halinde kürdanları parafinle işleyin.

RU Конструктор не требует применения клея. **UKR** Конструктор не вимагає застосування клею. **ENG** It is not required to use glue for the constructor. **DEU** Der Baukasten braucht kein Klebstoff. **FRA** La construction n'a pas besoin de colle. **POL** Konstruktor nie wymaga kleju. **SPA** El mecano no requiere el uso de pegamento. **ITA** Non richiede l'utilizzo della colla. **TUR** Tasarım tutkal kullanılmasını gerektirmez.

RU Хрупкие детали! При извлечении элементов конструктора из карты будьте аккуратны! **UKR** Тендітні деталі! При добуванні елементів конструктора з карти будьте обережні! **ENG** Fragile details! Be careful when removing the constructor elements from the card! **DEU** Brüchige Bauelemente! Seien Sie vorsichtig bei der Ausbau des Baukastens aus der Karte! **FRA** Détails fragiles! Faites attention en retirant les éléments de la construction de la carte! **POL** Kruche części! Po wyjęciu elementów konstruktora z karty bądź ostrożny! **SPA** Piezas frágiles! Sea prudente al sacar elementos de mecano de la tarjeta! **ITA** Dettagli fragili! Gli elementi vanno estratti dalla scheda con cautela! **TUR** Kırılgan parçalar! Karttan tasarım parçalarını çıkarırken dikkatli olun!

RU Все элементы входящие в зацепление необходимо зачистить наждачной бумагой и смазать парафином. **UKR** Всі елементи, які входять у зачеплення необхідно зачистити наждачною папером і змастити парафіном. **ENG** All the elements that interlock must be sanded with a sandpaper and greased with paraffin wax. **DEU** Alle Bauelemente, die zum Eingriff kommen, muss man mit dem Sandpapier polieren und mit dem Paraffin schmieren. **FRA** Il faut nettoyer tous les éléments de l'accrochage à l'aide du papier-émeri et les traiter avec de la paraffine. **POL** Wszystkie elementy wchodzące do użyczenia należy oczyścić papierem ściernym i nasmarować parafiną. **SPA** Hay que limpiar con papel de lija y aplicar parafina a todos los elementos que entran en el enganche. **ITA** Tutti gli elementi facenti parte dell'ingranamento devono essere limati con carta vetrata e spalmati con paraffina. **TUR** Çapakları zımpara kağıdı ile işleyin ve parafinle yağlayın.

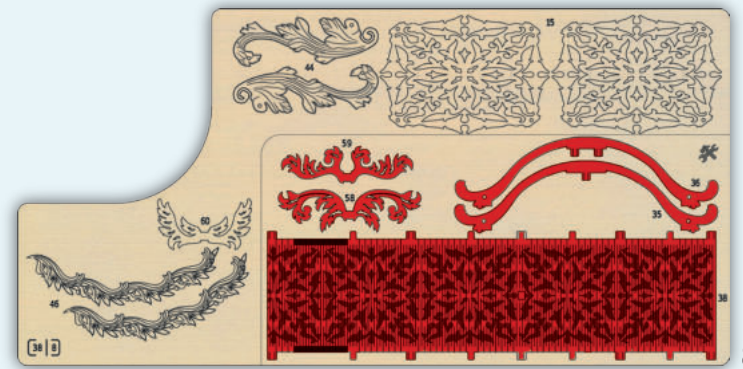

RU Запасные части. **UKR** Запасні деталі. **ENG** Spare parts. **DEU** Ersatzteile. **FRA** Pièces de rechange. **POL** Części zamienne. **SPA** Repuestos. **ITA** Pezzi di ricambio. **TUR** Yedek parçalar.

RU Вспомогательный инструмент для сборки или измерения расстояний. **UKR** Допоміжний інструмент для збірки або вимірювання відстаней. **ENG** Auxiliary tool for assembling or measuring distances. **DEU** Hilfsinstrument für Montage und Messung der Entfernungen. **FRA** Outil auxiliaire pour l'assemblage ou pour la mesure de distance. **POL** Narzędzie pomocnicze do montażu lub pomiaru odległości. **SPA** Herramienta auxiliar para ensamblar o medir distancias. **ITA** Strumento ausiliario per l'assemblaggio o per la misura delle distanze. **TUR** Montaj ve ya mesafe ölçümü için yardımcı alet.

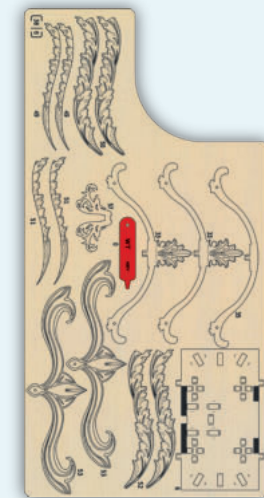
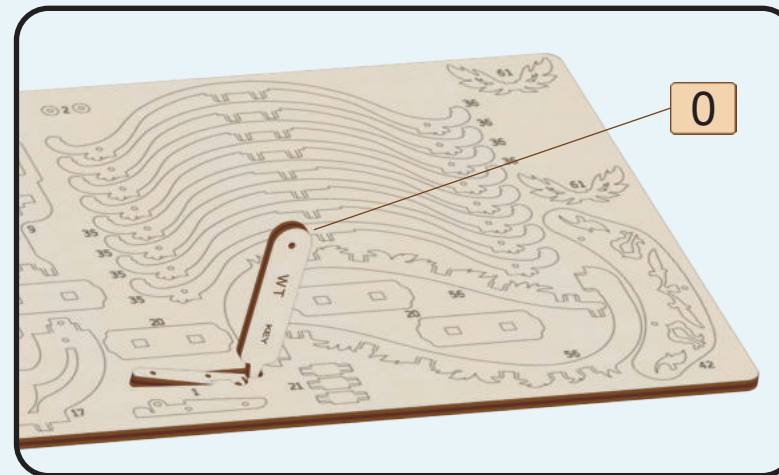

6

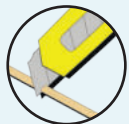

RU Отрезать зубочистку. UKR Відрізати зубочистку. ENG Cut off a toothpick. DEU Den Stocher abschneiden. FRA Couper la cure-dent. POL Odetnij wykałaczkę. SPA Cortar el mondadientes. ITA Tagliare lo stecchino. TUR Kürdani kes.

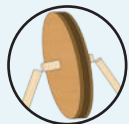

RU Обломать с двух сторон. UKR Обломати з двох сторін. ENG Break off from both sides. DEU Beiderseitig hinbiegen. FRA Épointer de deux côtés. POL Oblamaj z dwu stron. SPA Romper de dos lados. ITA Spezzare su entrambi i lati. TUR İki tarafından kır.



RU Удалить заусеницы. UKR Видалити задирки. ENG Remove burrs. DEU Niednägel entfernen. FRA Enlever les bavures. POL Usuń zadziory. SPA Quitar rebabas. ITA Eliminare le bave. TUR Çapakları temizle.



RU Обратит внимание! UKR Зверніть увагу! ENG Note! DEU Lenken sie aufmerksamkeit! FRA Faire attention! POL Zwróć uwagę! SPA Prestar atención! ITA Fate attenzione! TUR Dikkat edilmelidir!



RU Смазать парафином. UKR Змастити парафіном. ENG Cock the mechanism. DEU Mit dem Paraffin schmieren. FRA Traiter avec de la paraffine. POL Posmaruj parafiną. SPA Aplicar parafina. ITA Spalmare con paraffina. TUR Parafinle yağla.

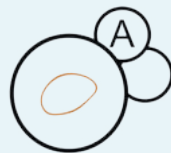

RU Маленькая резинка. UKR Маленька гумка. ENG Small rubber band. DEU Kleines Gummiband. FRA Petit élastique. POL Mała gumka. SPA Tira de goma pequeña. ITA Gomma piccola. TUR Küçük lastik.

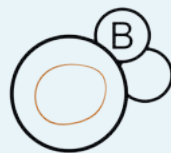

RU Средняя резинка. UKR Середня гумка. ENG Medium rubber band. DEU Mittleres Gummiband. FRA Moyen élastique. POL Średnia gumka. SPA Tira de goma mediana. ITA Gomma media. TUR Orta lastik.



RU Рычаг пуска. UKR Важіль пуску. ENG Start lever. DEU Auslösehebel. FRA Embrayeur. POL Dźwignia rozruchu. SPA Palanca de arranque. ITA Leva di avviamento. TUR Devreye alma kolu.



RU Необходимо сложить резинку вдвое. UKR Необхідно скрутити резинку вдвічі. ENG It is necessary to twist the rubber band twice. DEU Man muss das Gummiband zweifach drehen. FRA Il faut tordre la gomme élastique en deux. POL Należy skręcić gumę o połowę. SPA Es necesario torcer la goma dos veces. ITA E' necessario torcere la gomma in due.



RU Сборка в зеркальном отражении. UKR Збірка в дзеркальному відображенні. ENG Assembly in mirror reflection. DEU Montage in spiegelreflexion. FRA Assemblage en réflexion spéculaire. POL Montaż w odbiciu lustrzanym. SPA Imagen del ensamblaje en el espejo. ITA Assemblaggio in riflessione speculare. TUR Ayna görüntüsünde montaj.



RU Сборка окончена. UKR Збірка закінчена. ENG Assembly is completed. DEU Die aufbau ist zu ende. FRA L'assemblage est fait. POL Montaż jest skończony. SPA Ensamblaje acabado. ITA L'assemblaggio è finito. TUR Montaj tamamlandı.

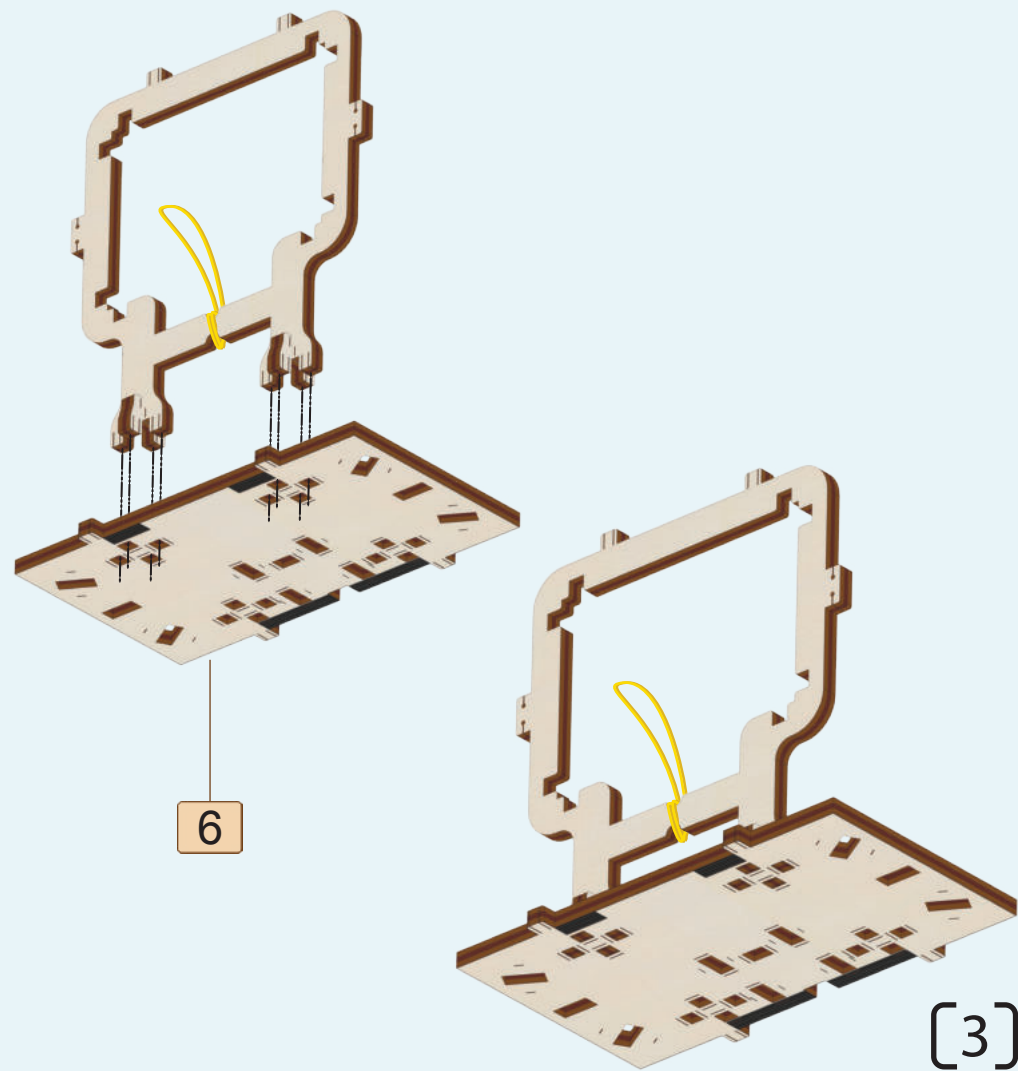
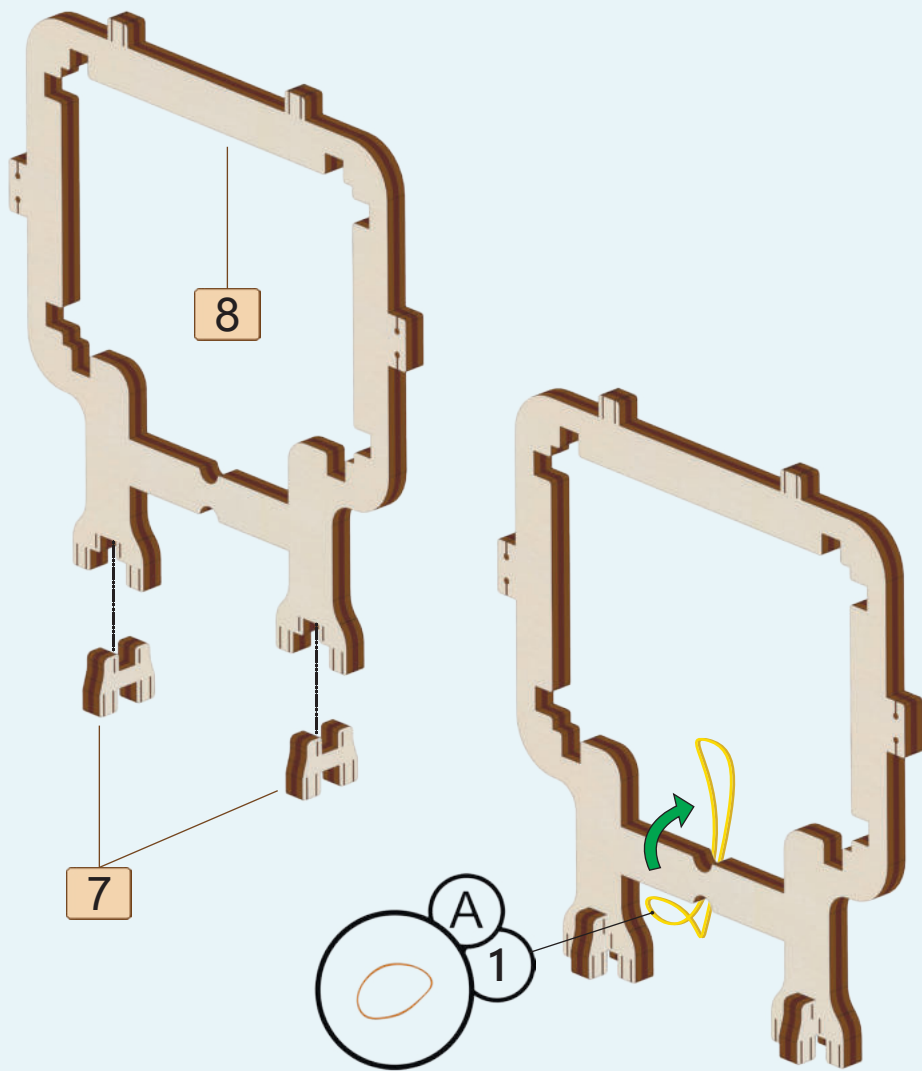
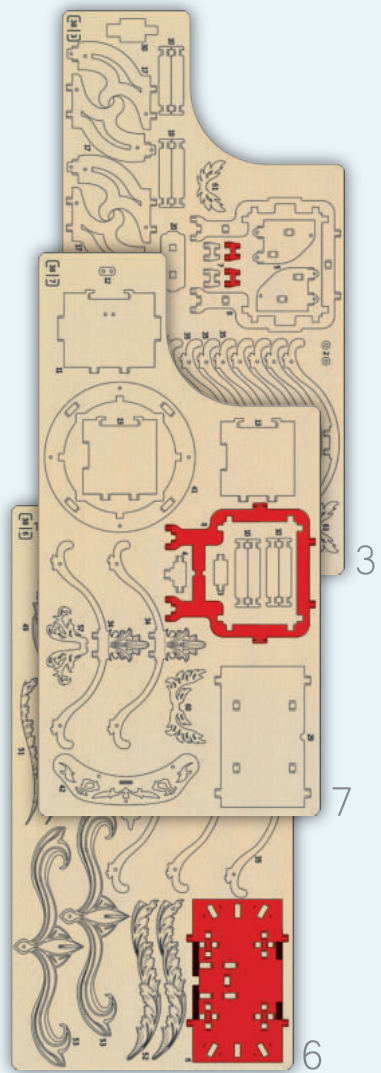

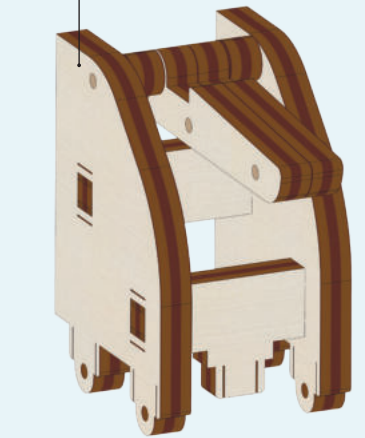
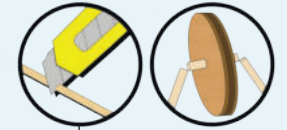
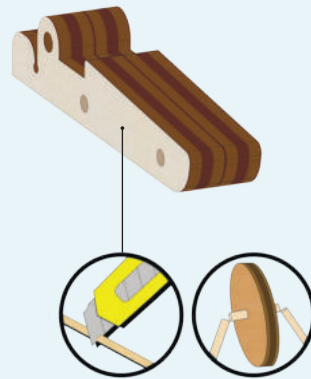
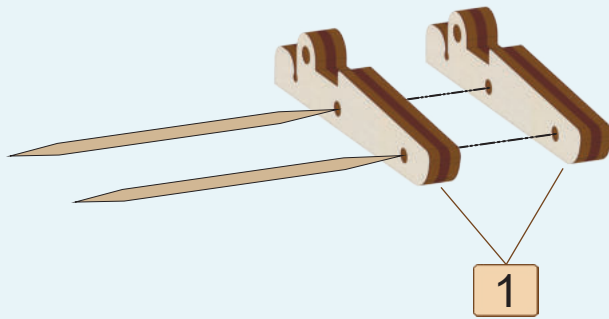
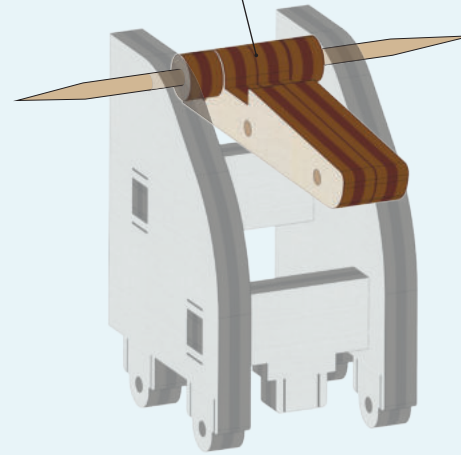
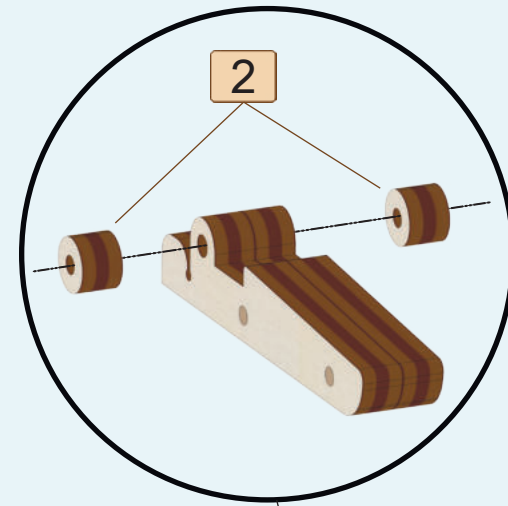
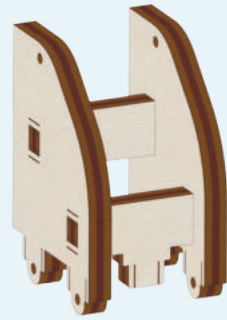
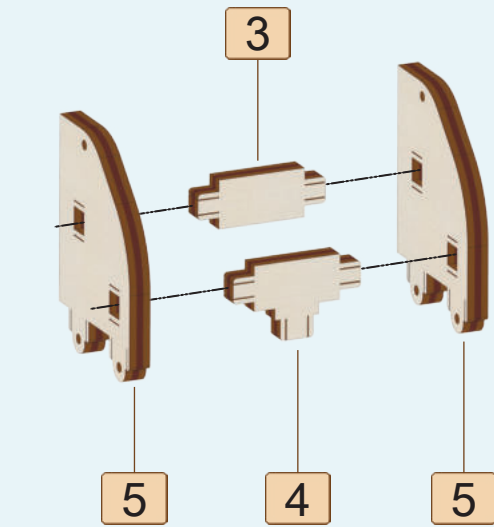
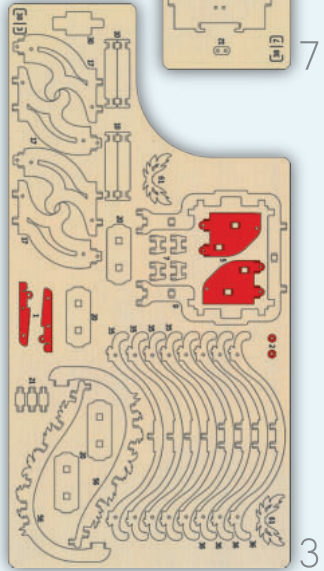
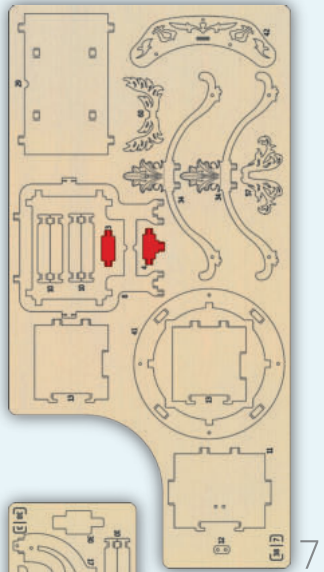

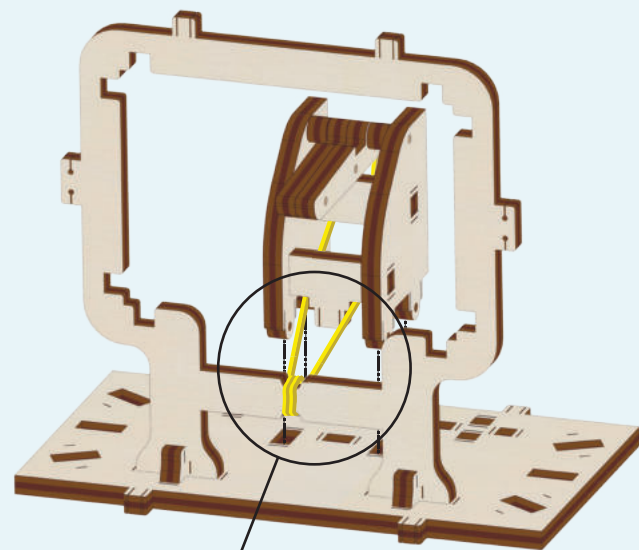
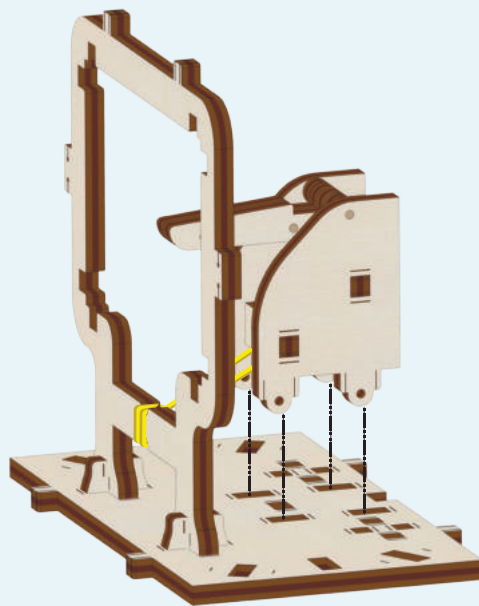
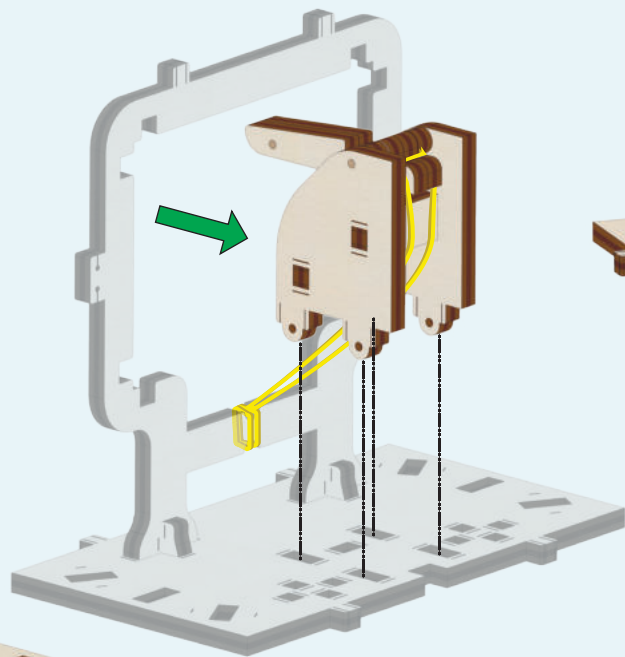
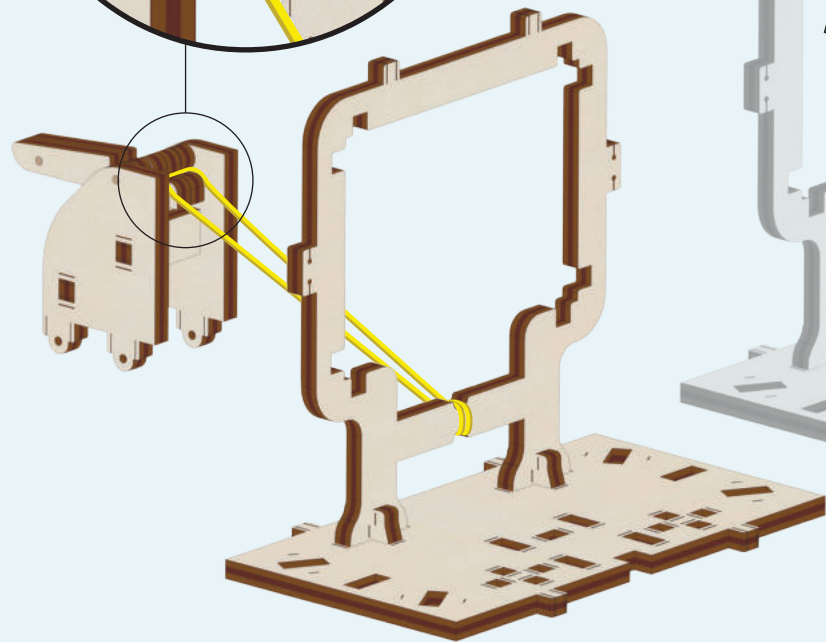
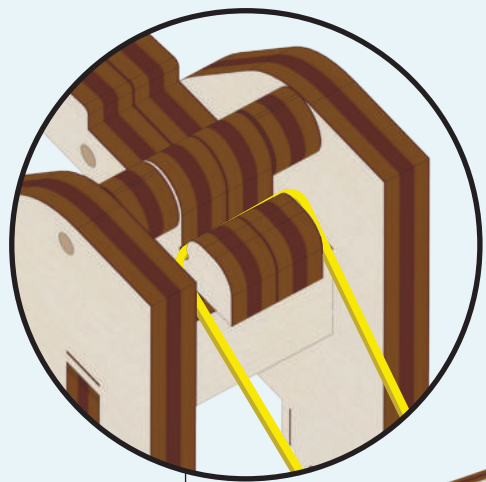

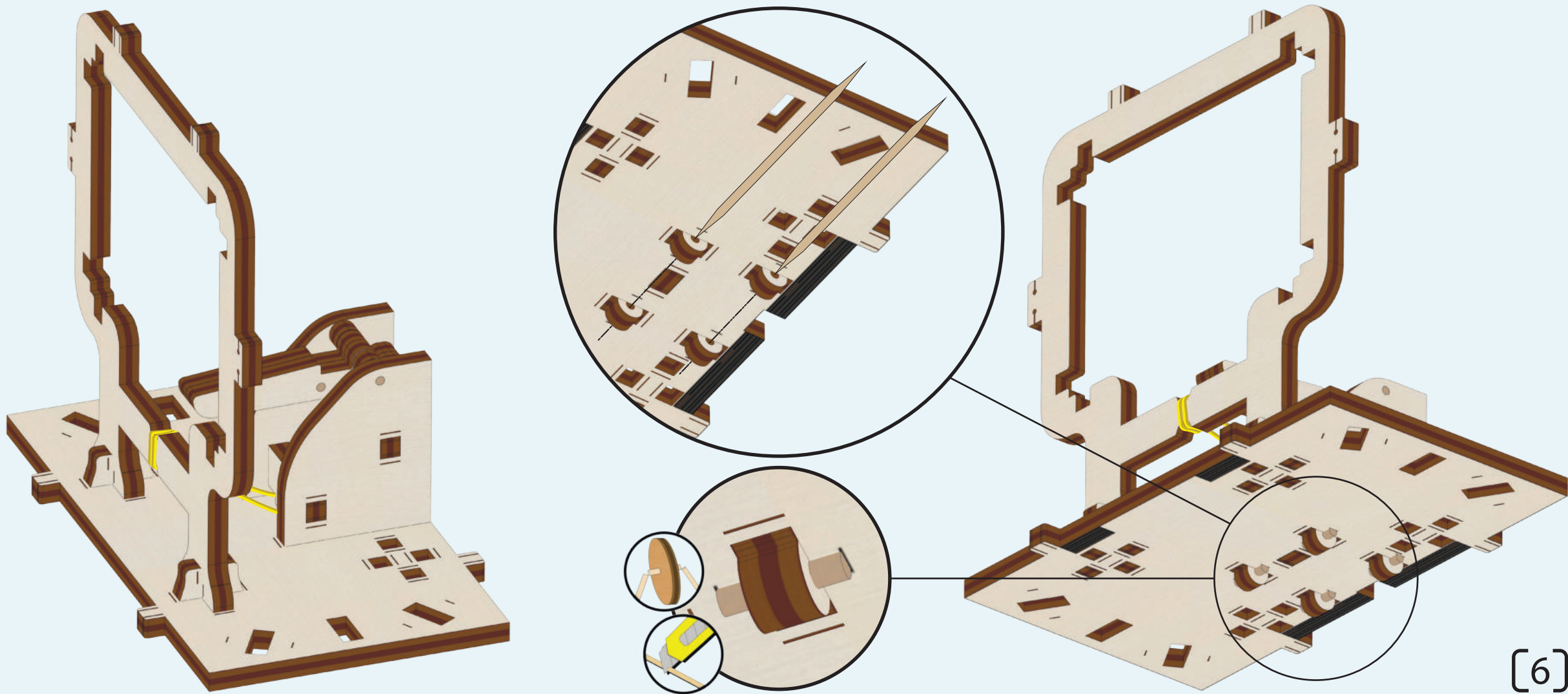

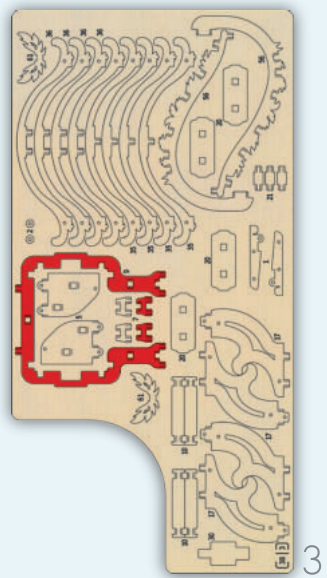

9

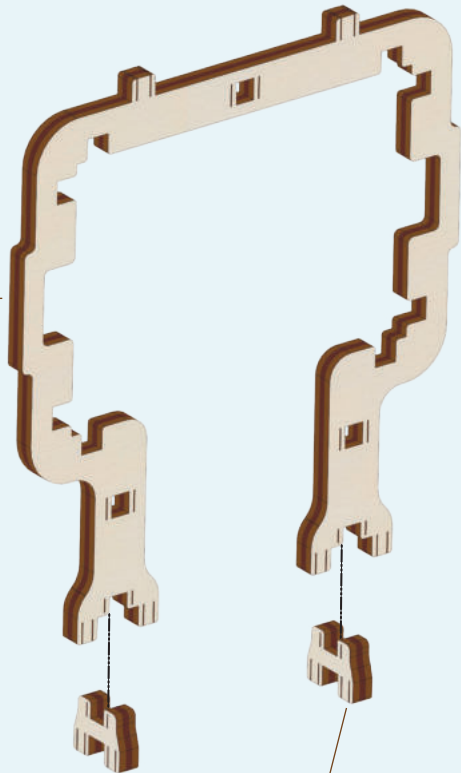

7

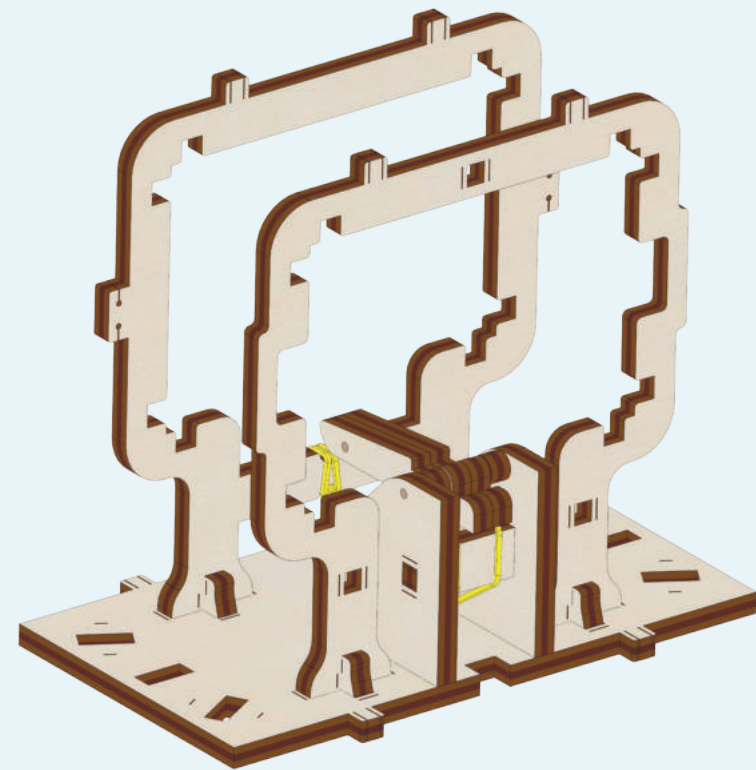
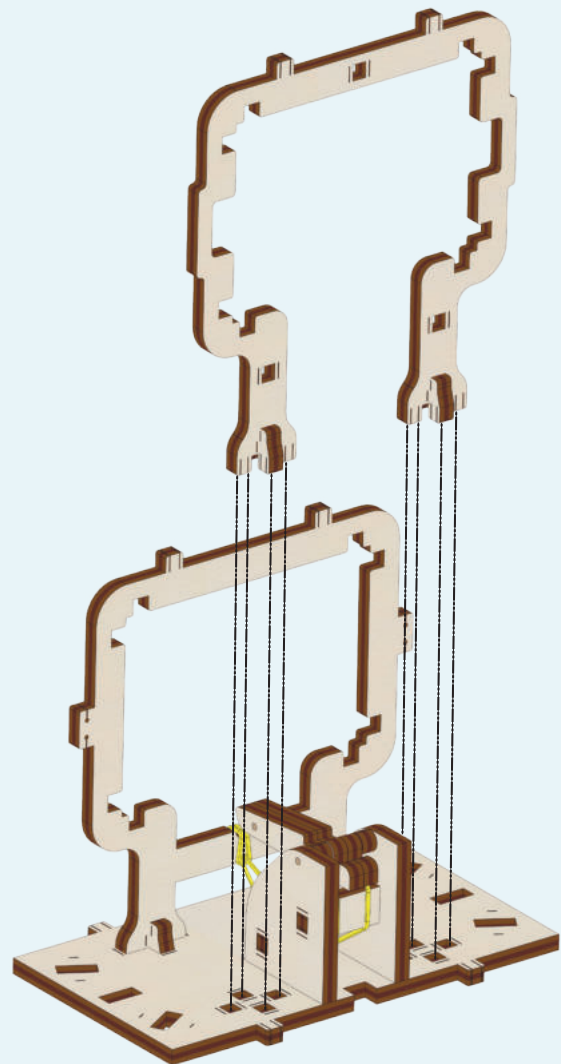
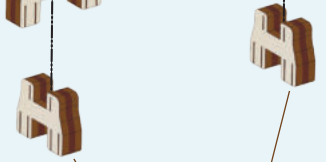

[7]

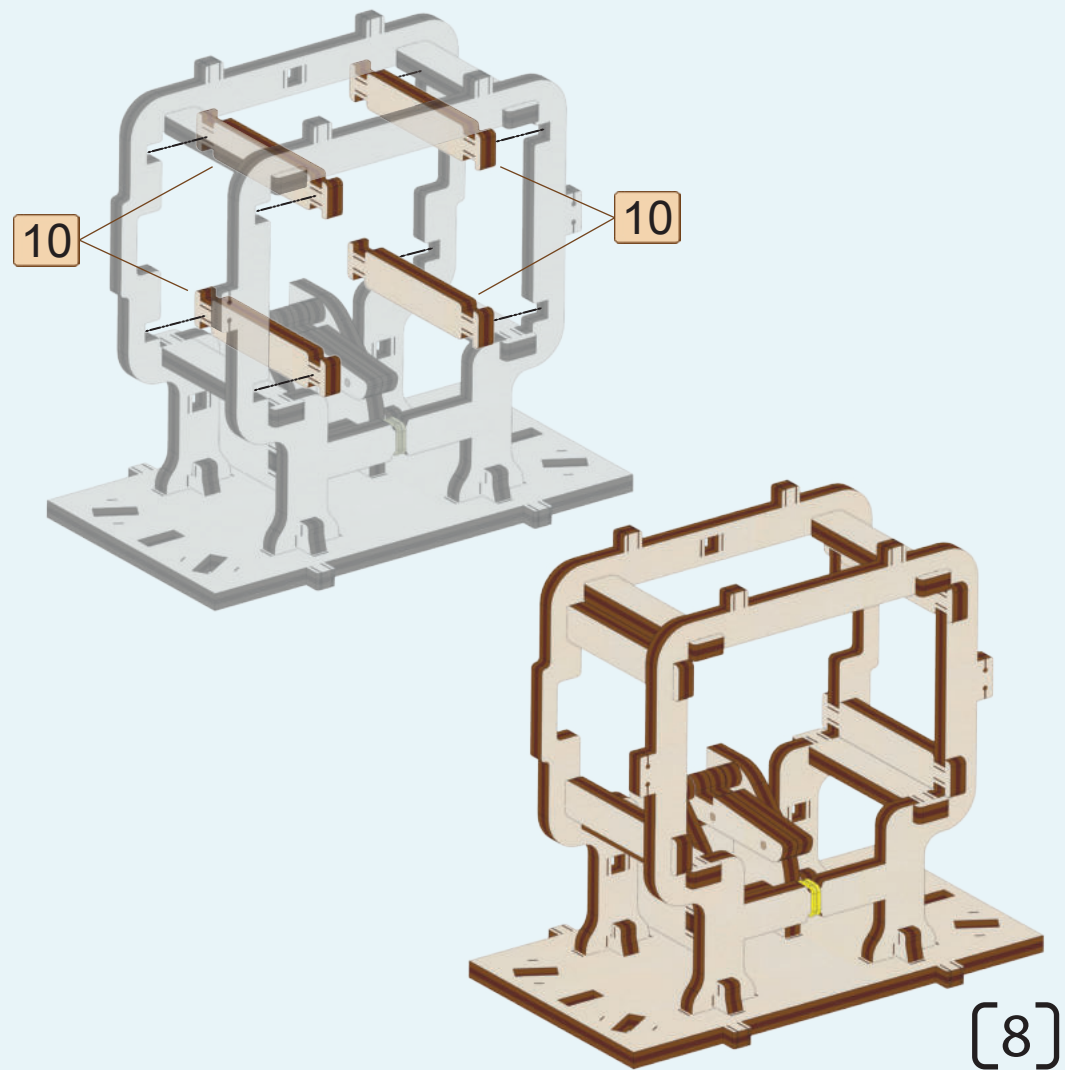
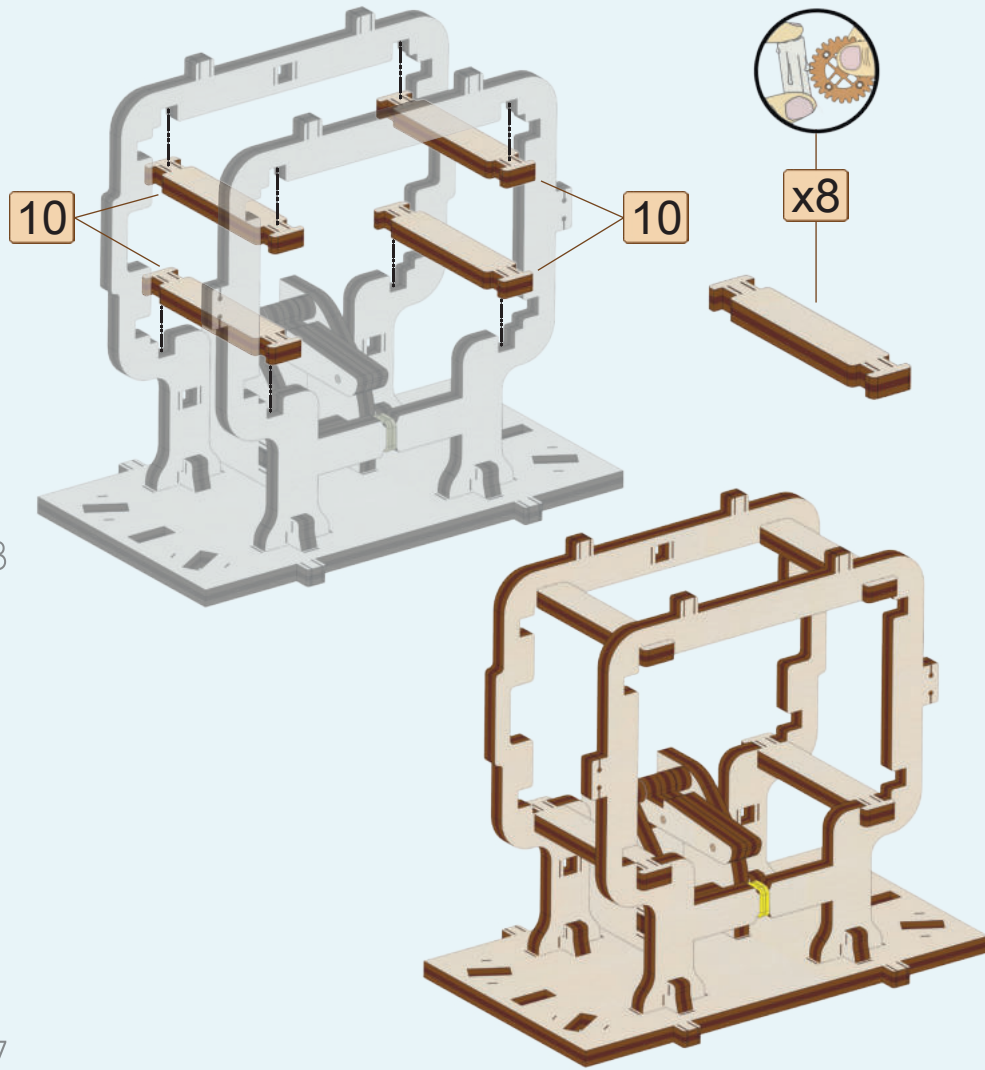
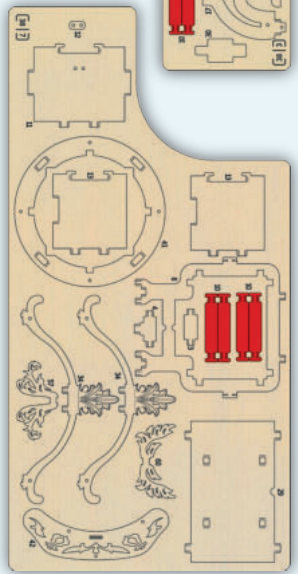
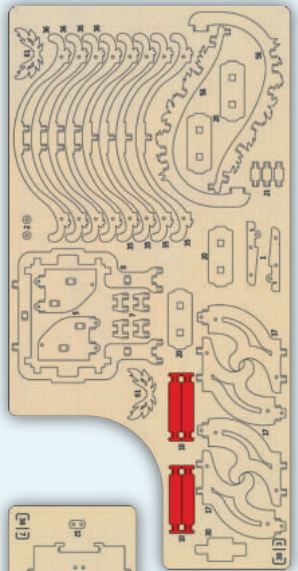

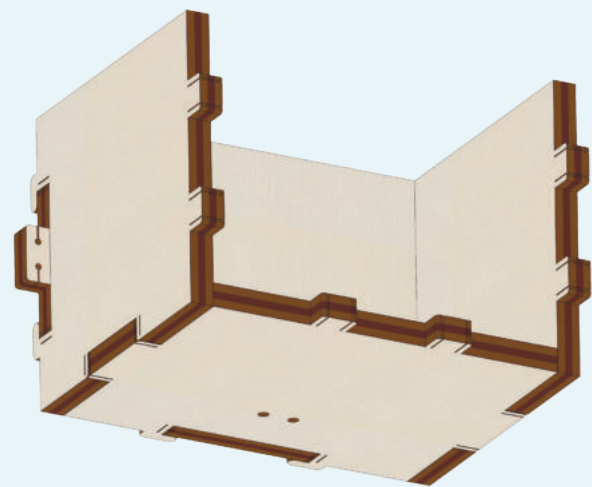
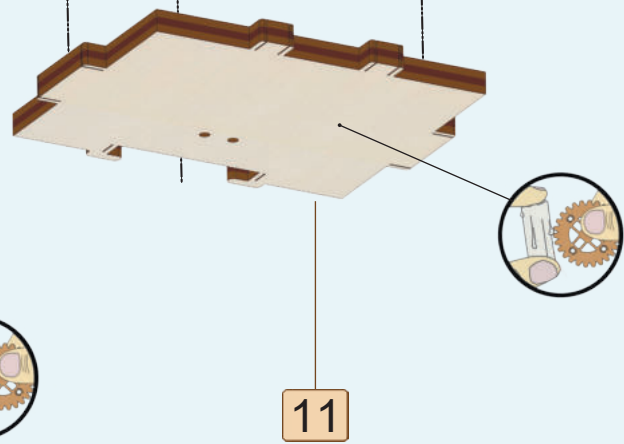
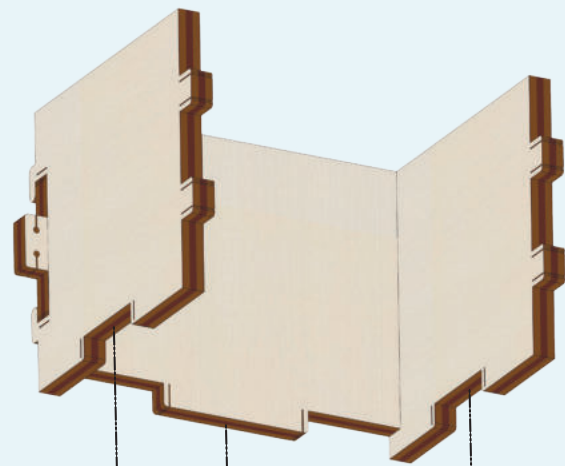
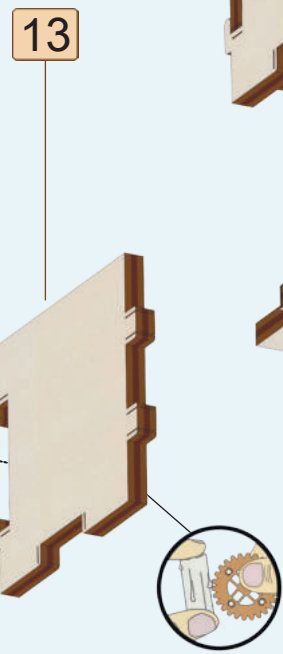
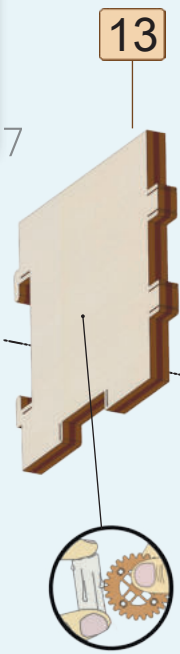

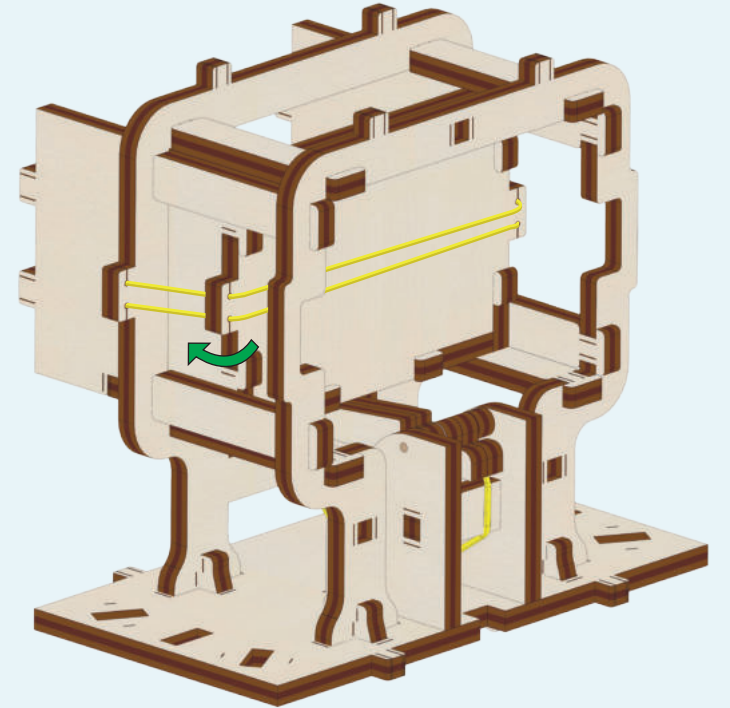
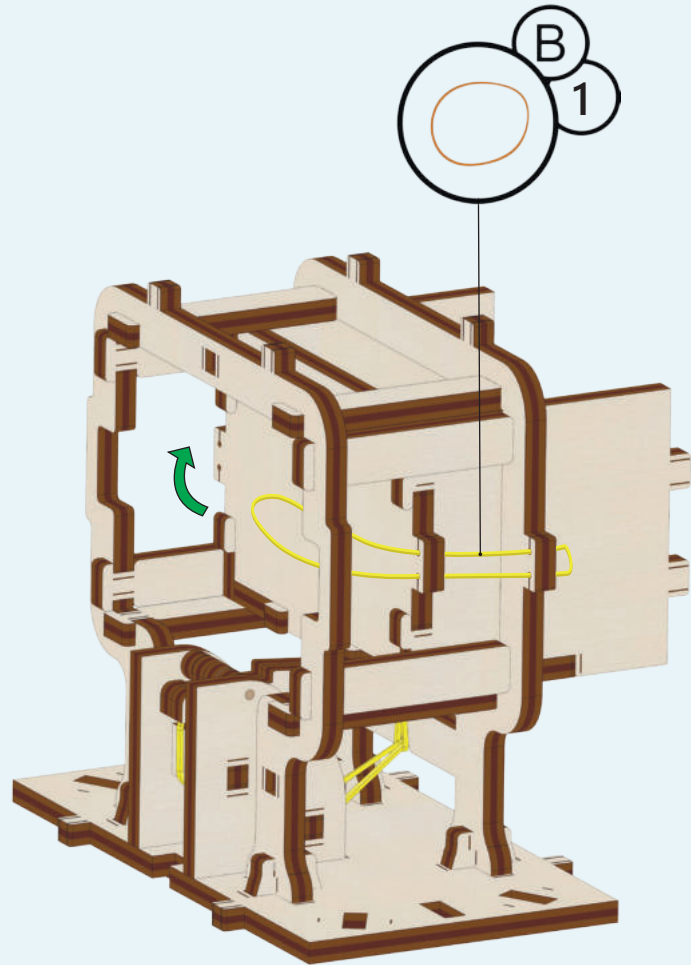
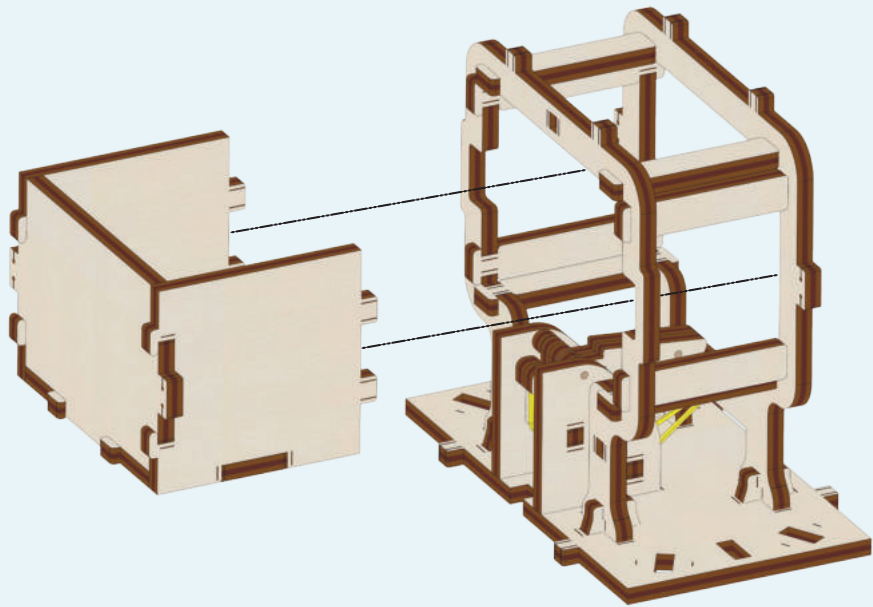

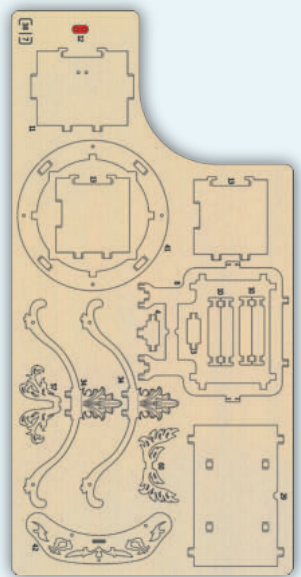

7

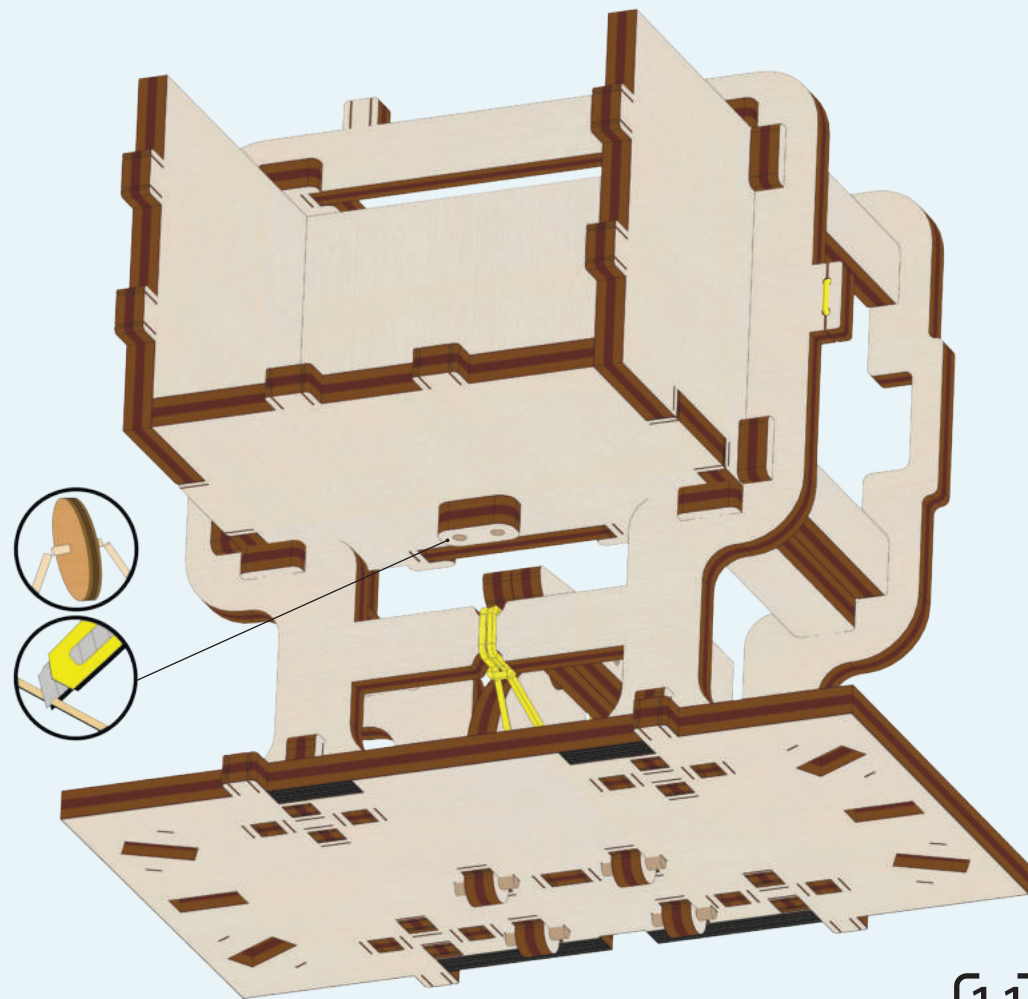
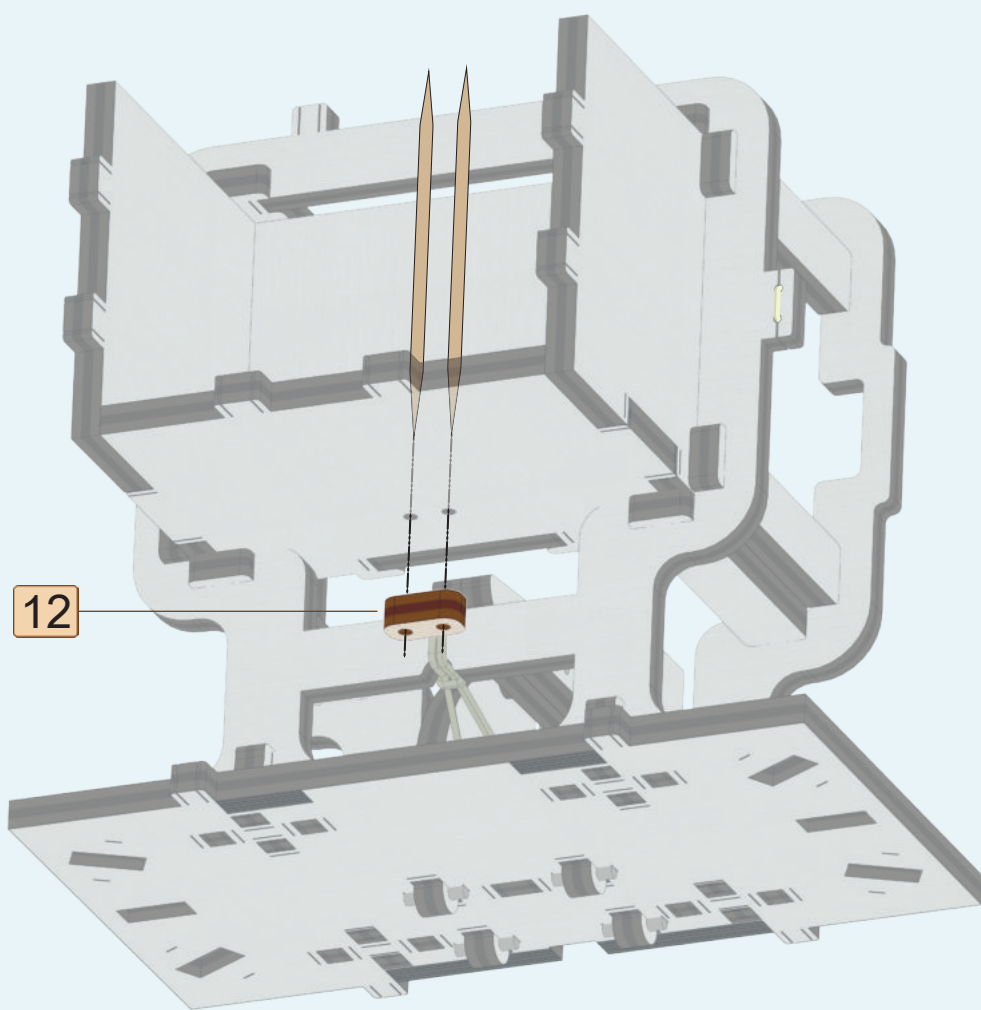

11

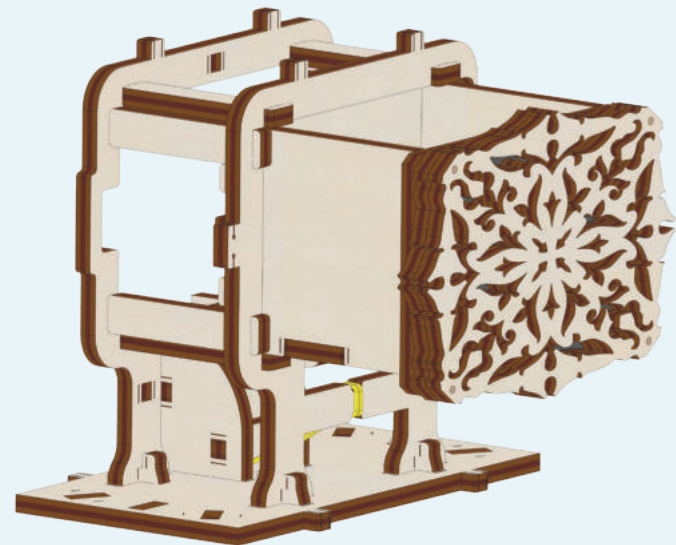
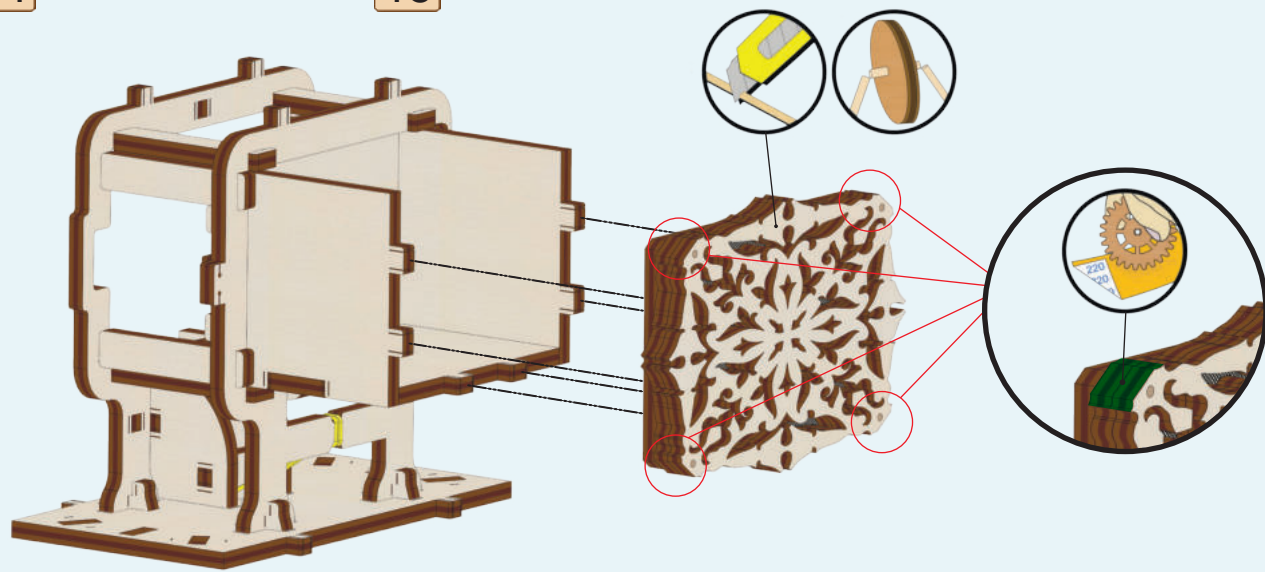
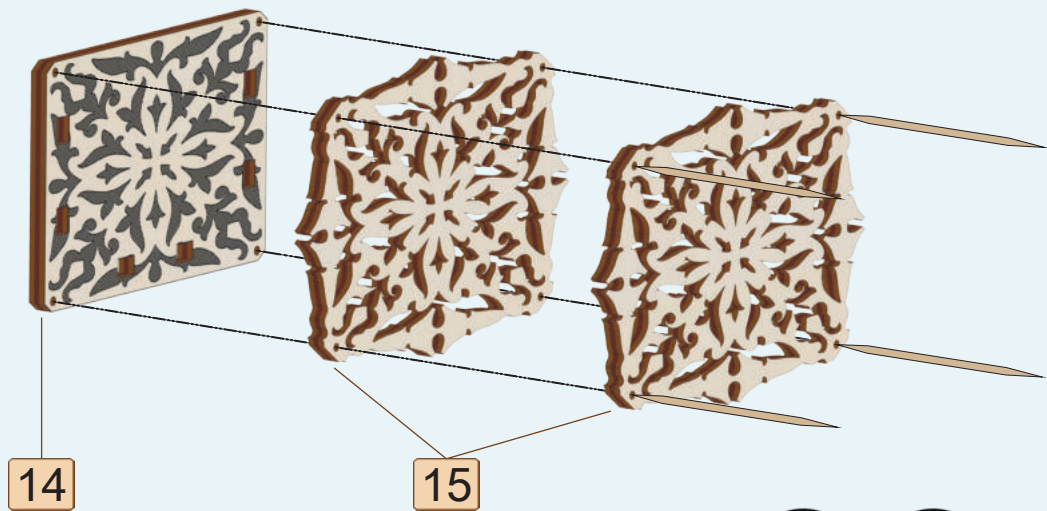
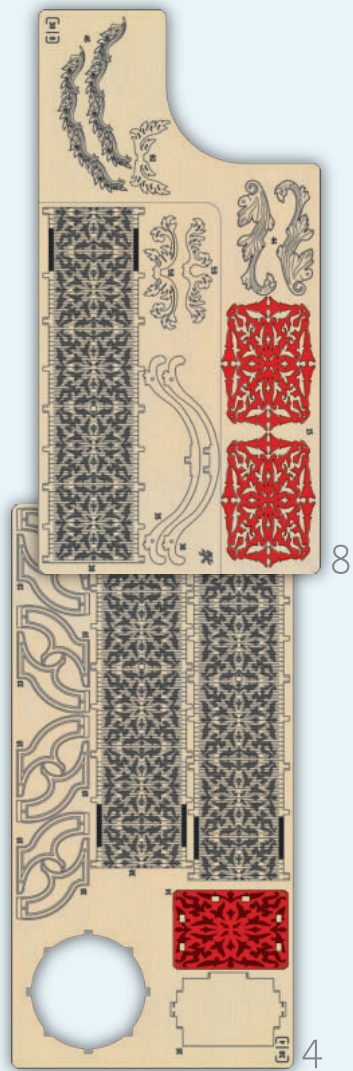

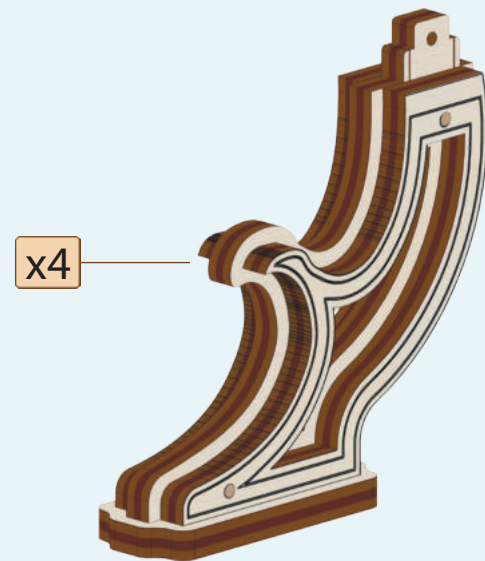
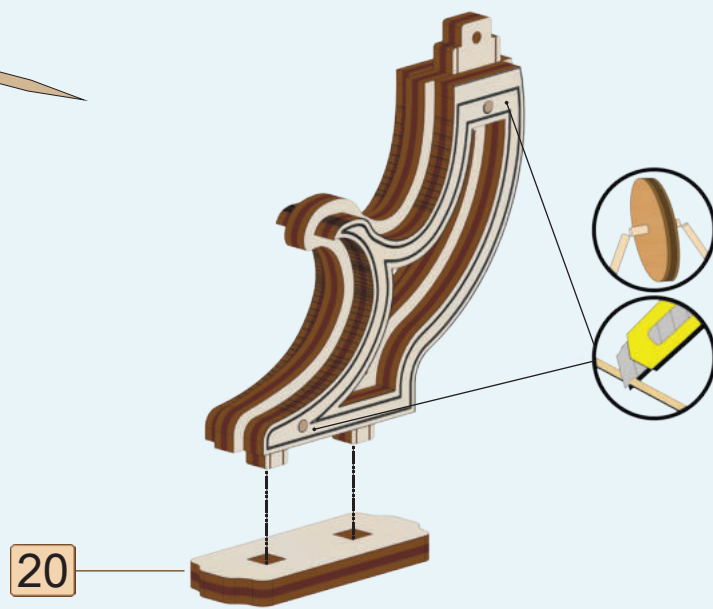
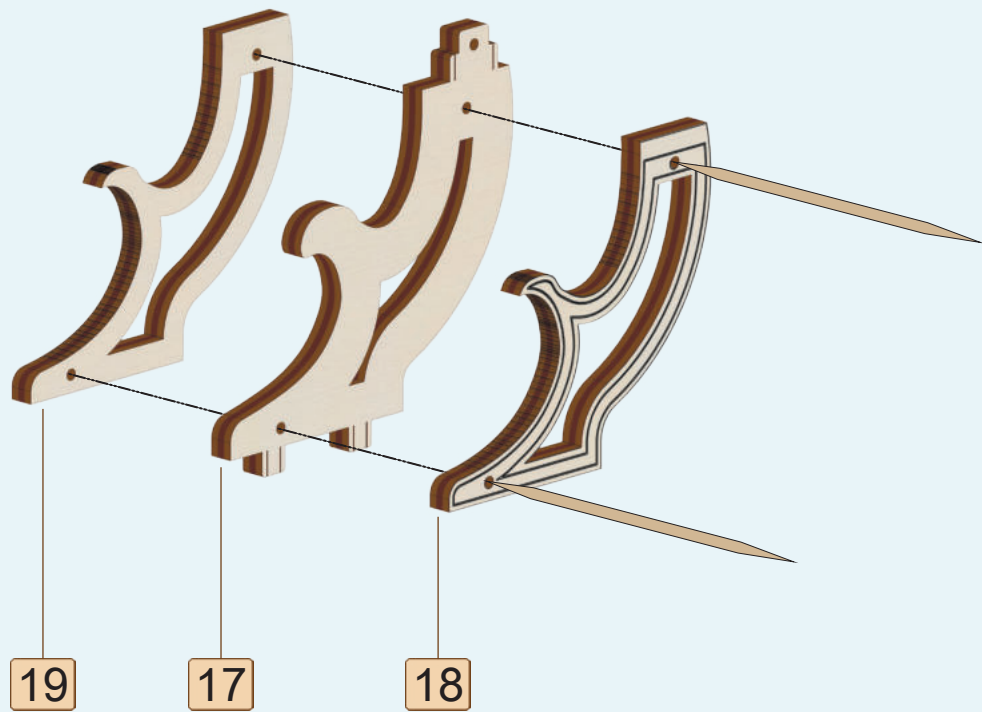
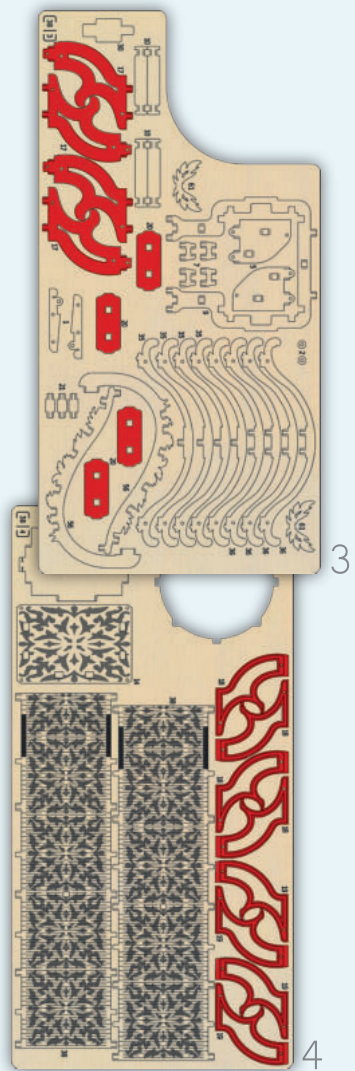

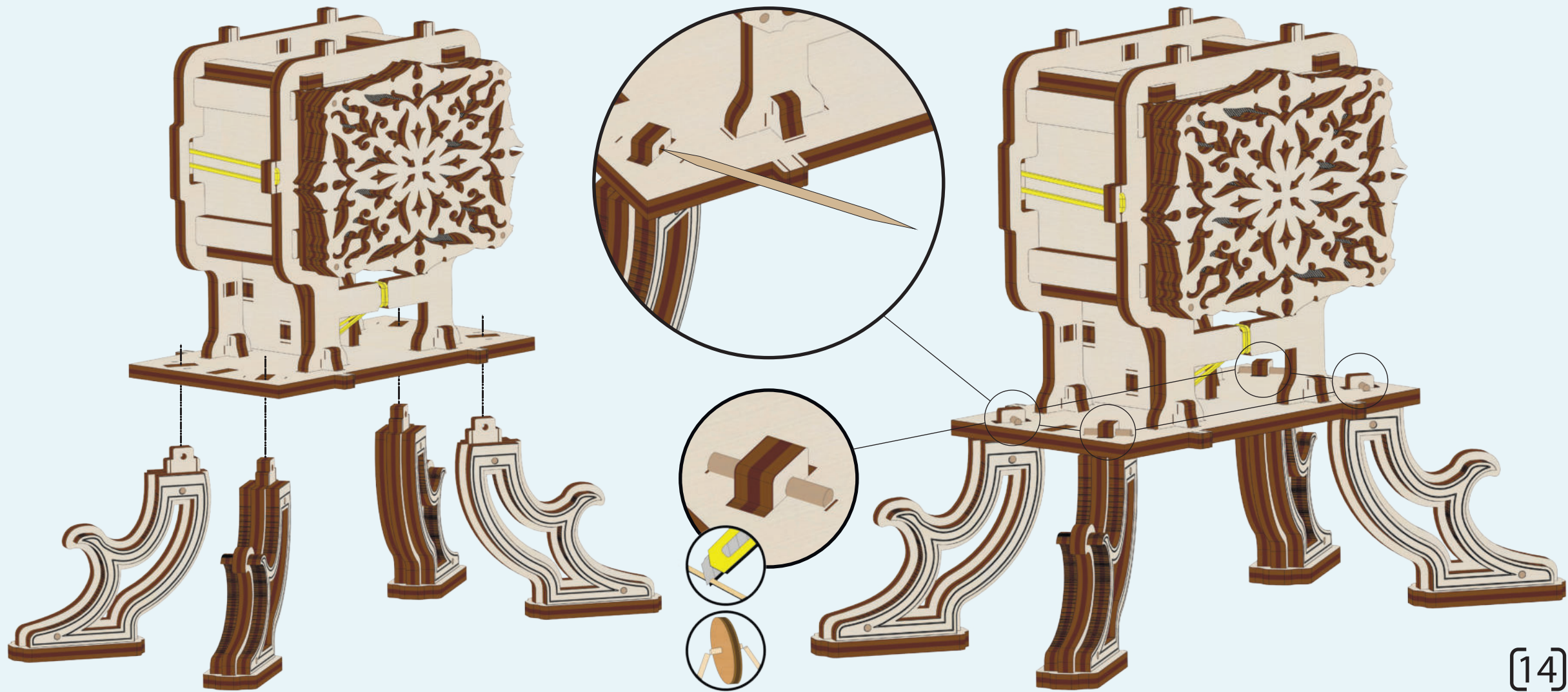

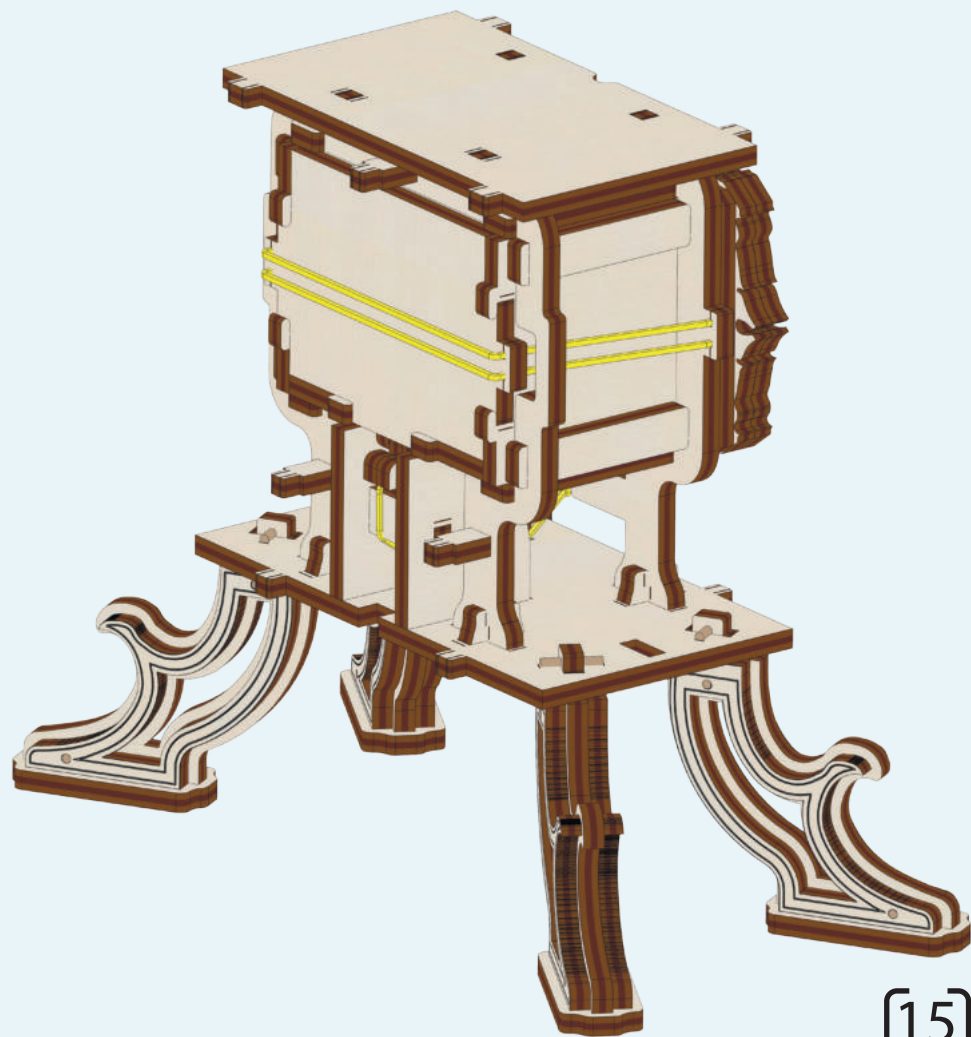
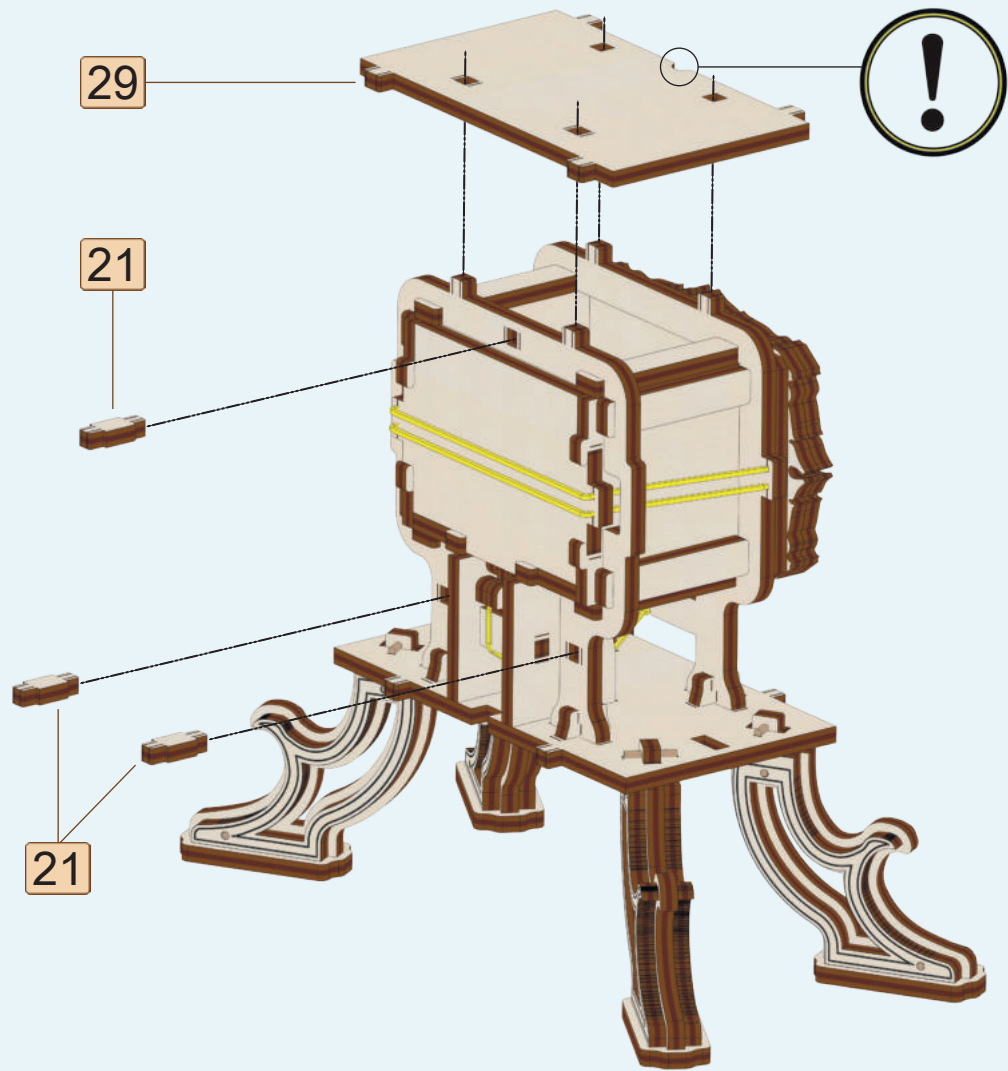
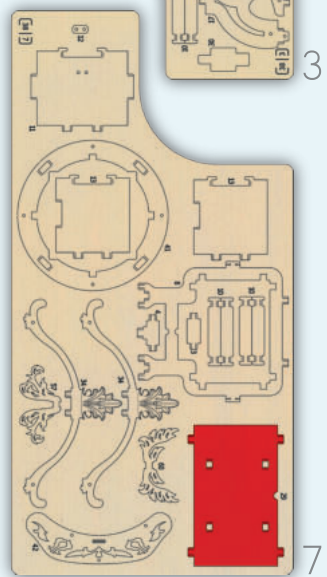
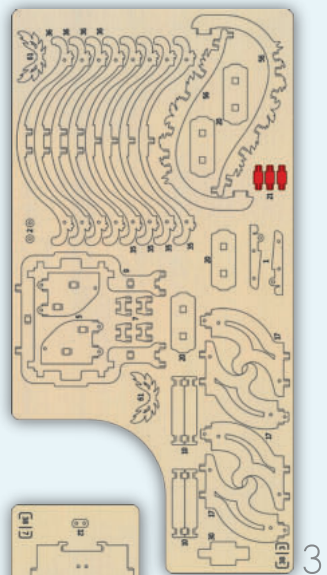

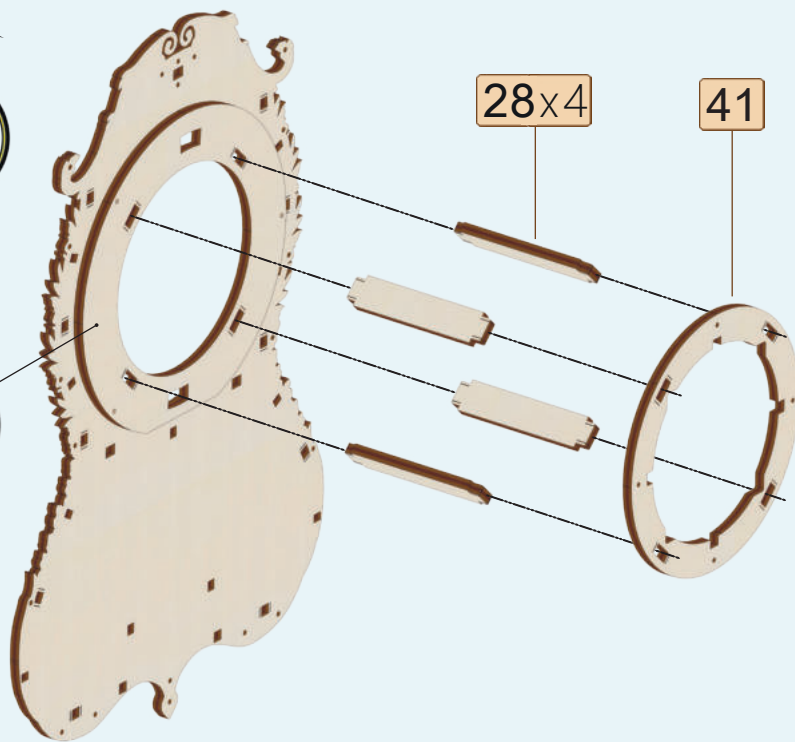
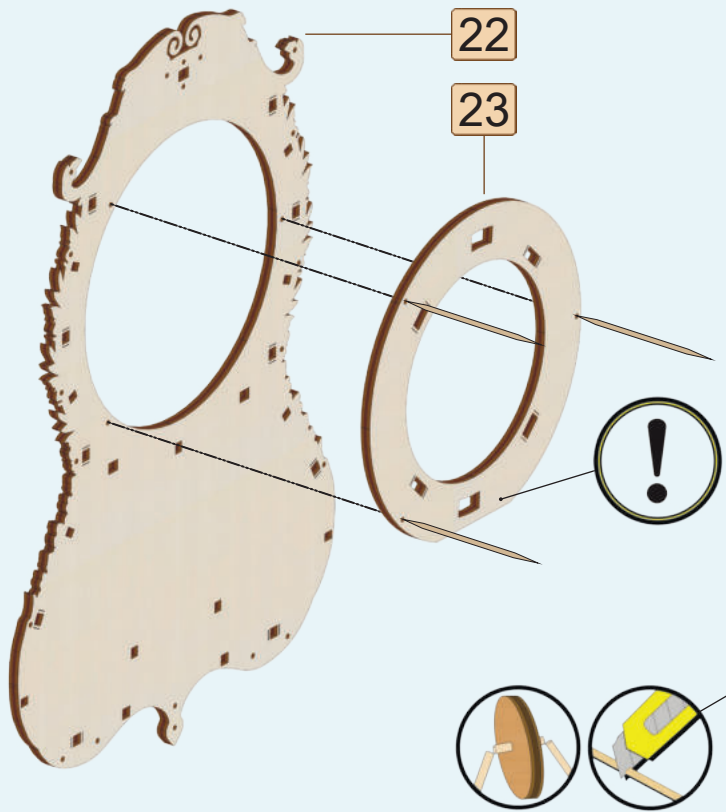

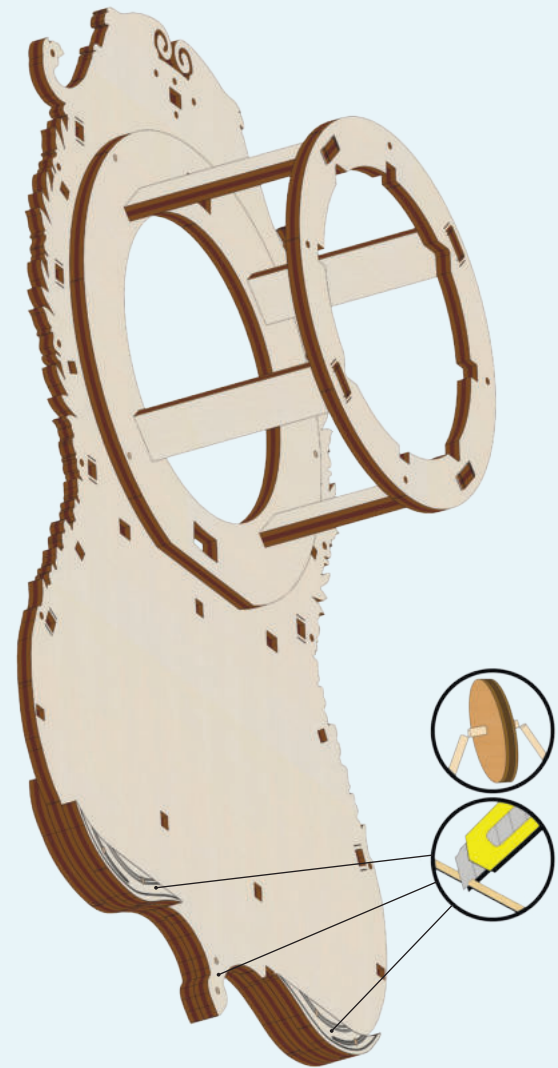
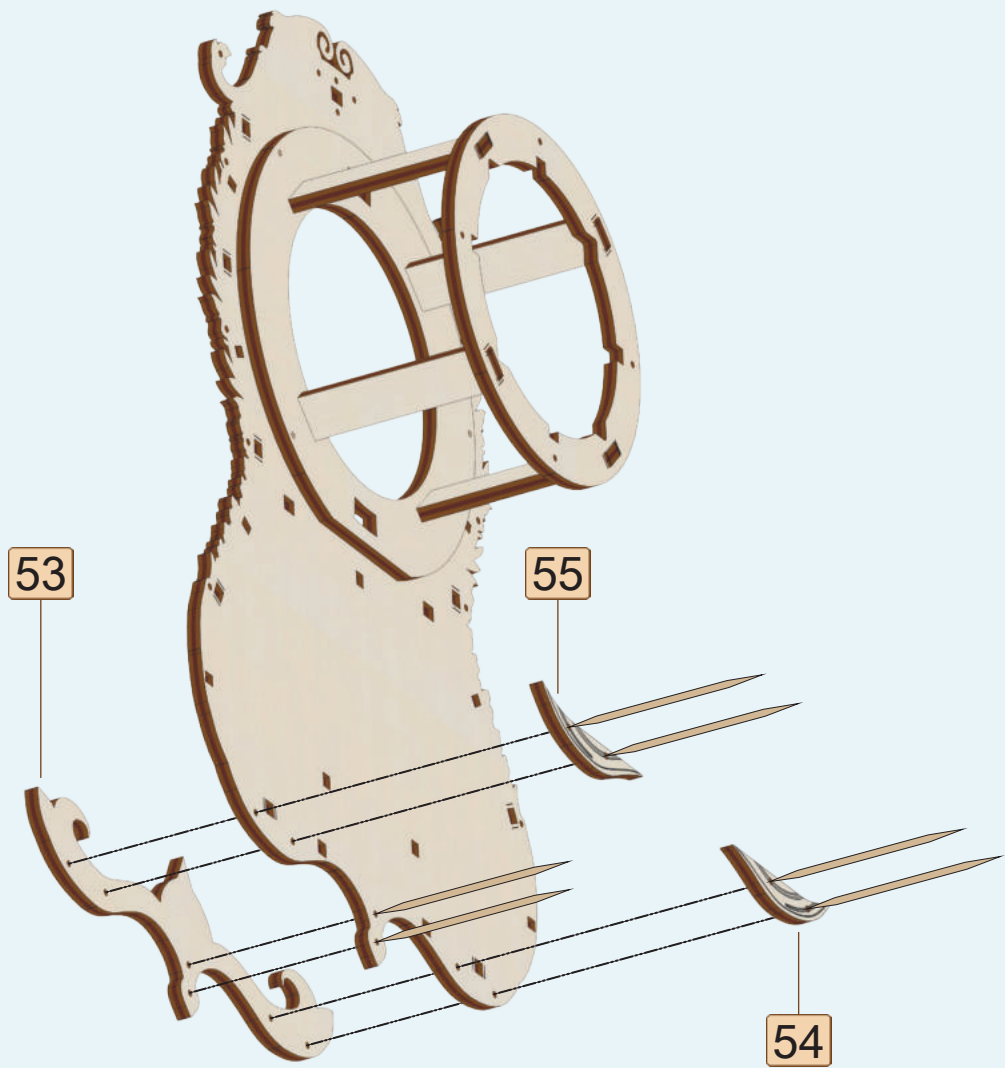
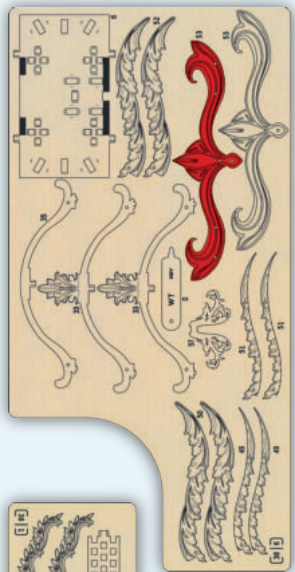

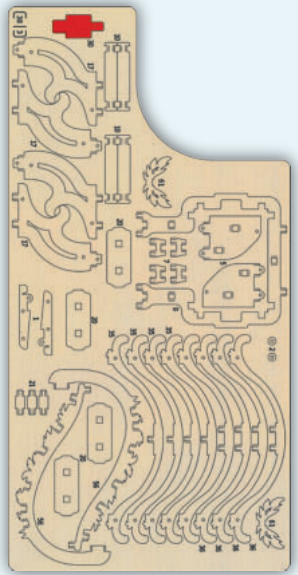

3

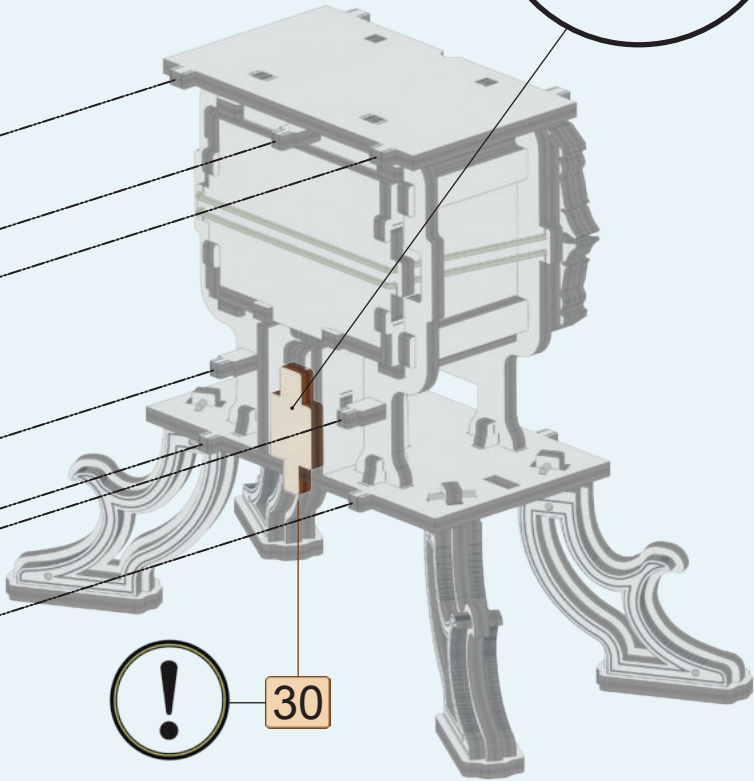

30

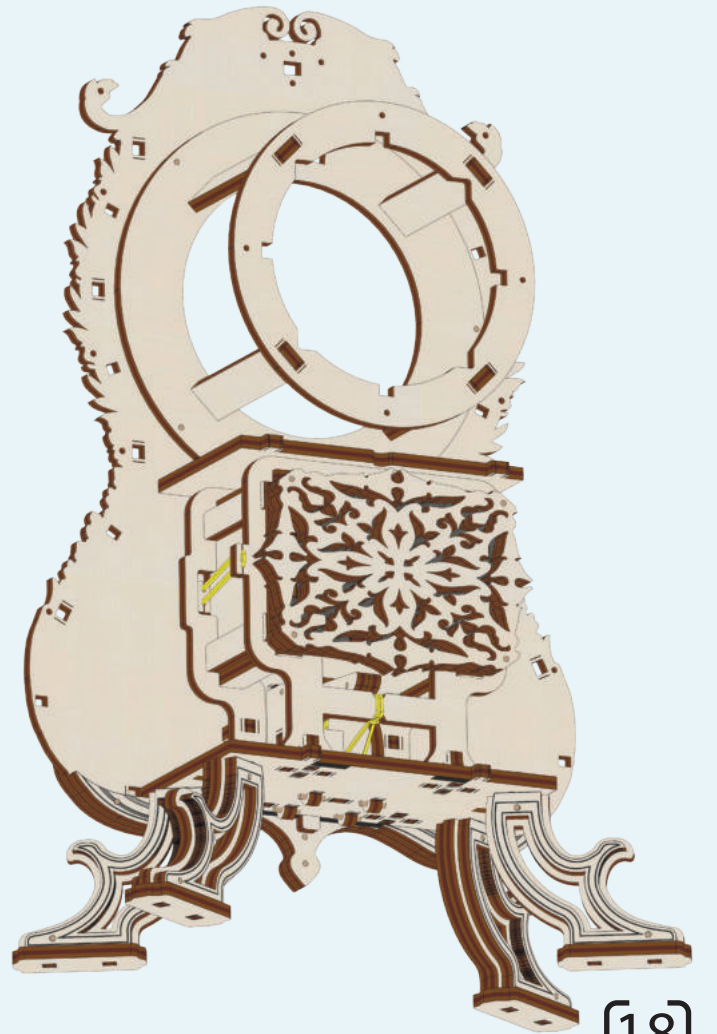

[18]

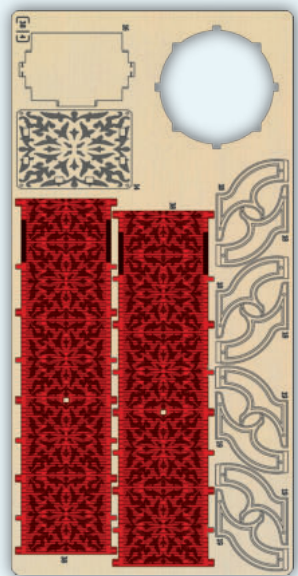

x2 38

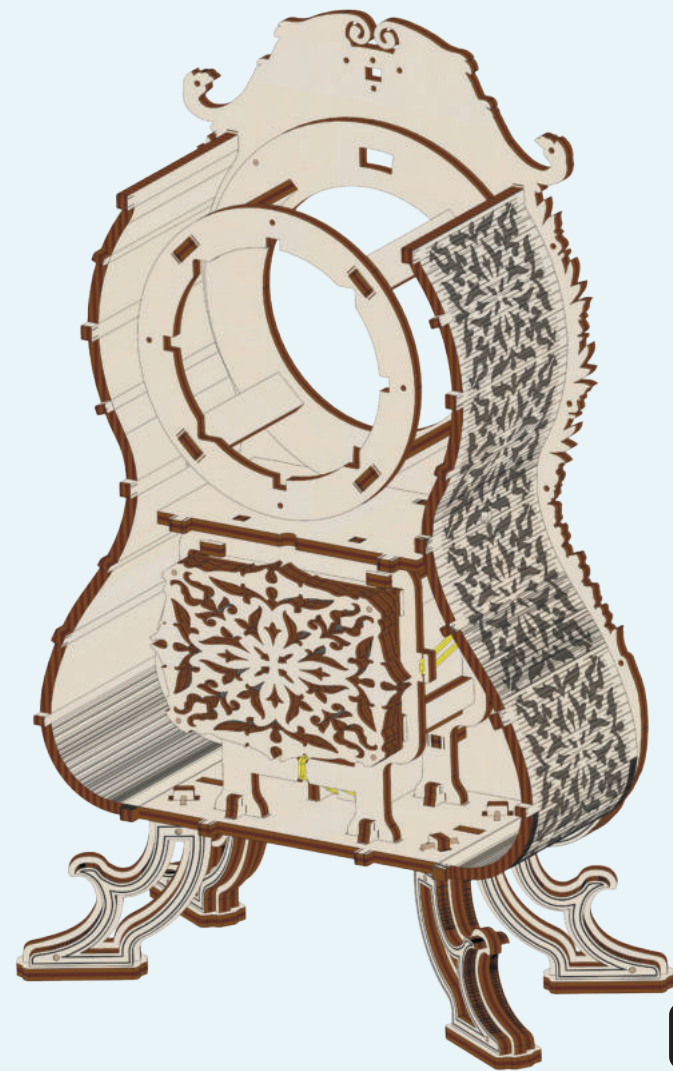
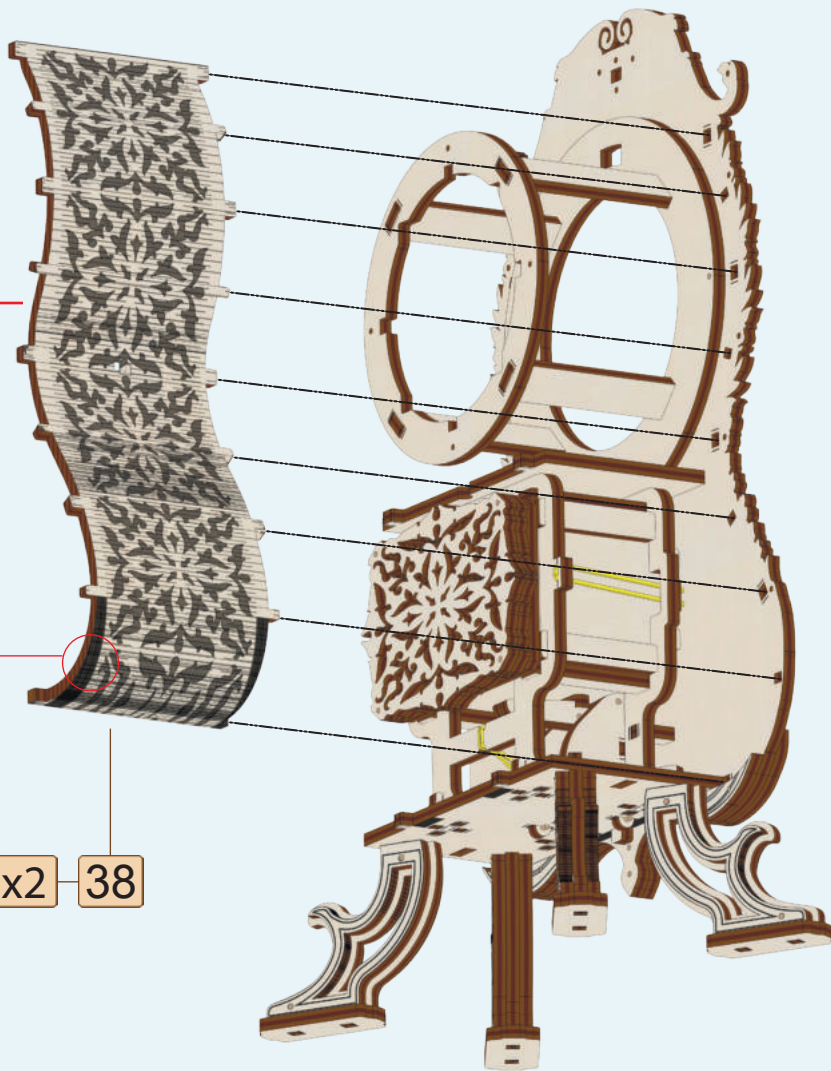

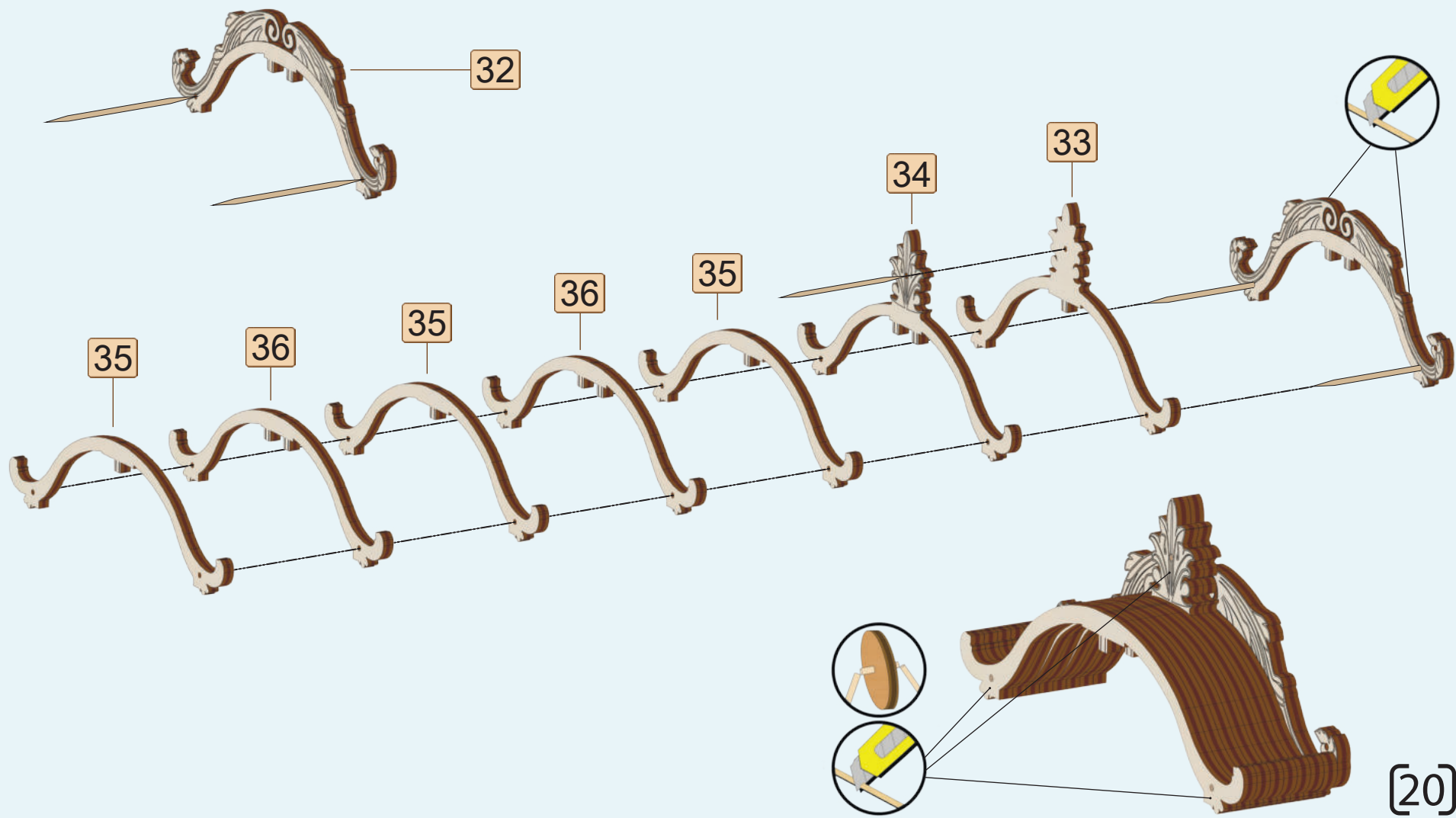
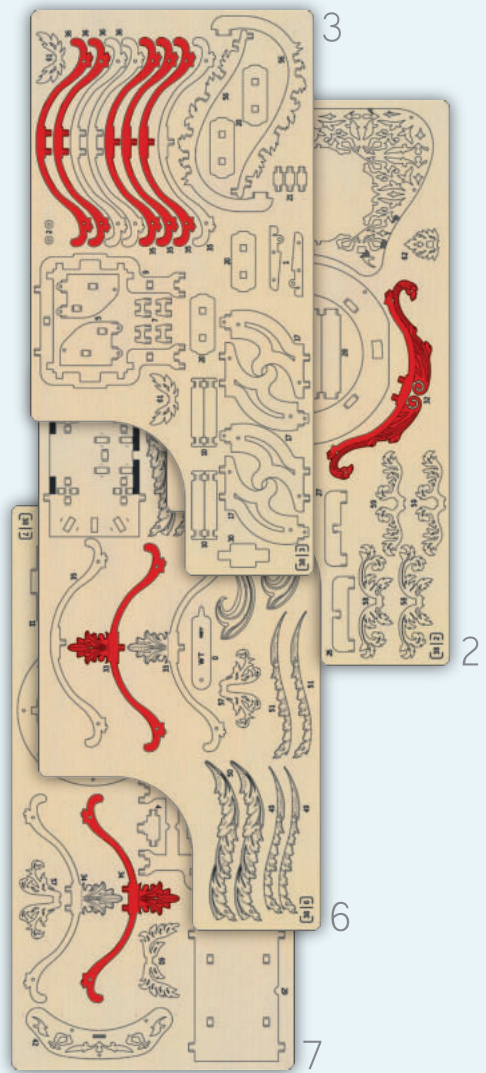

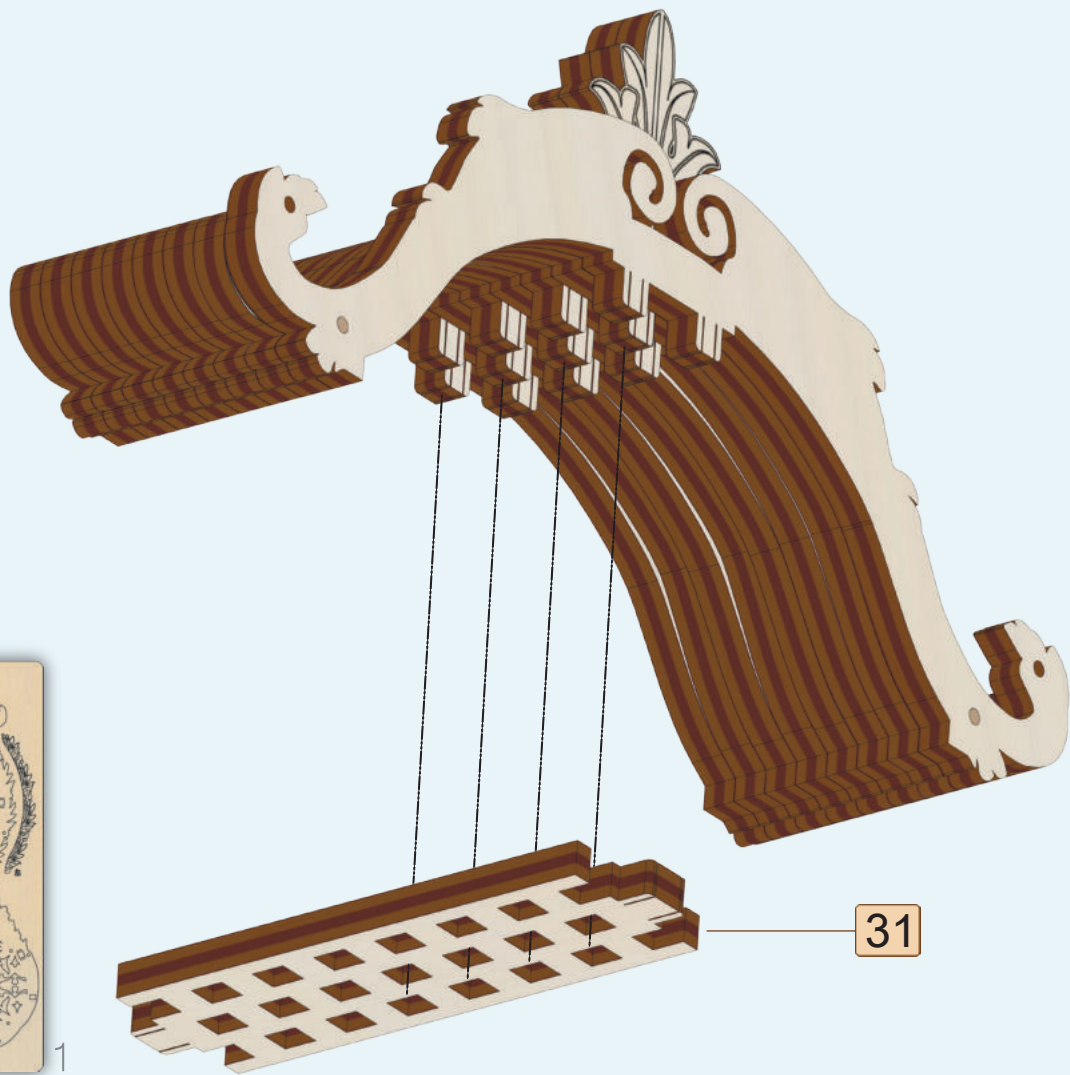

[21]

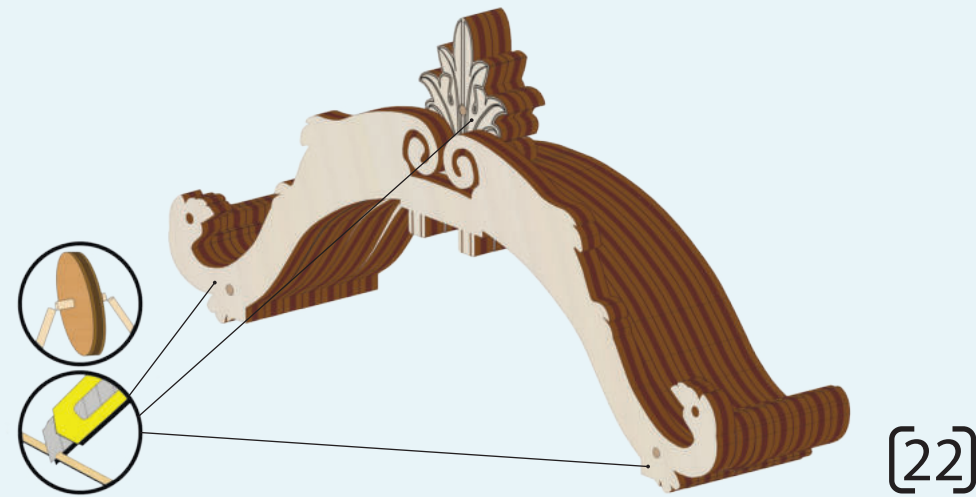
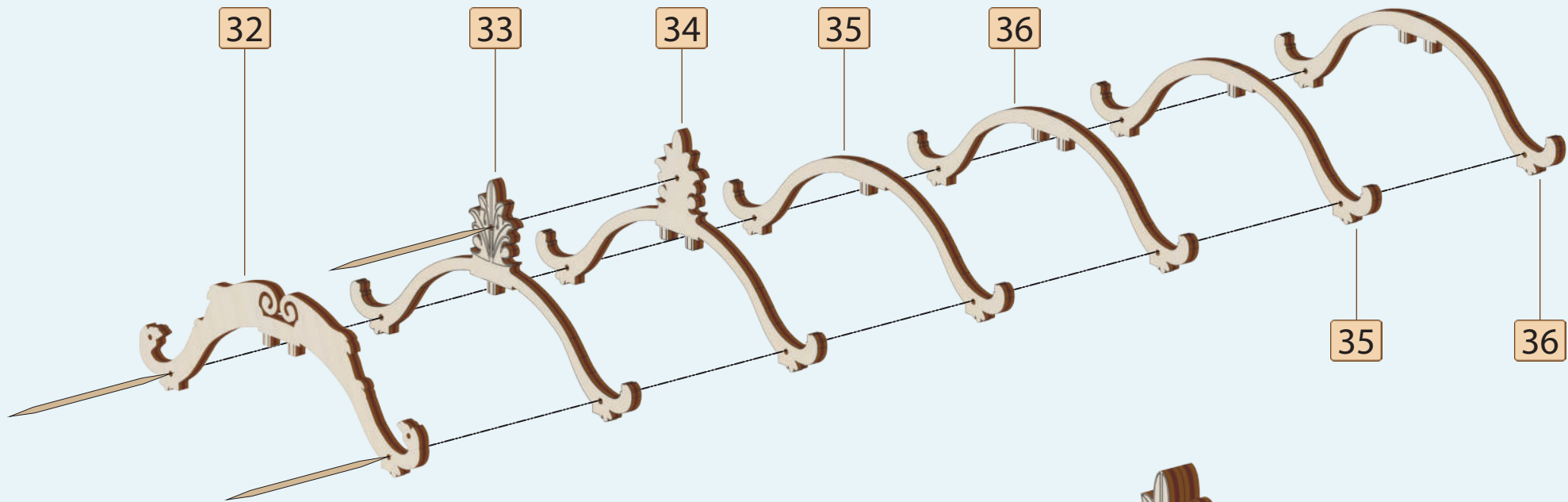
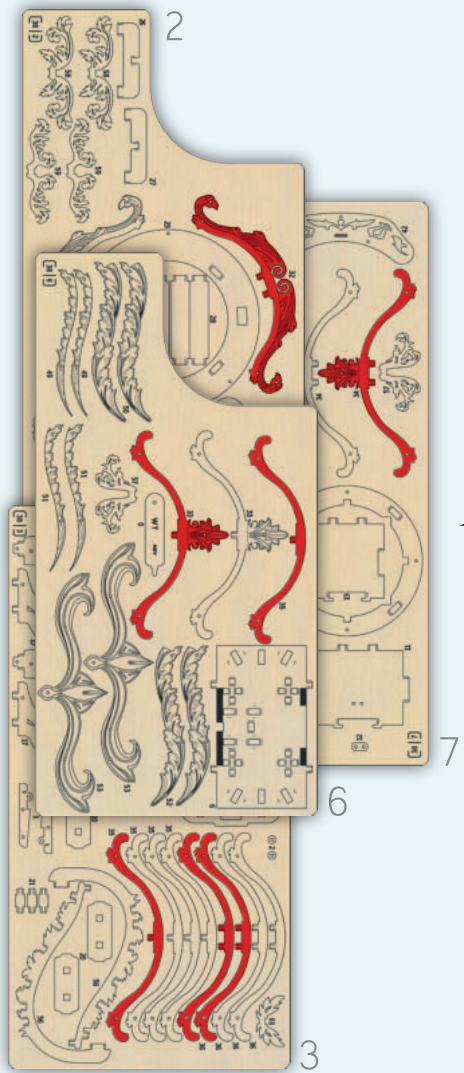

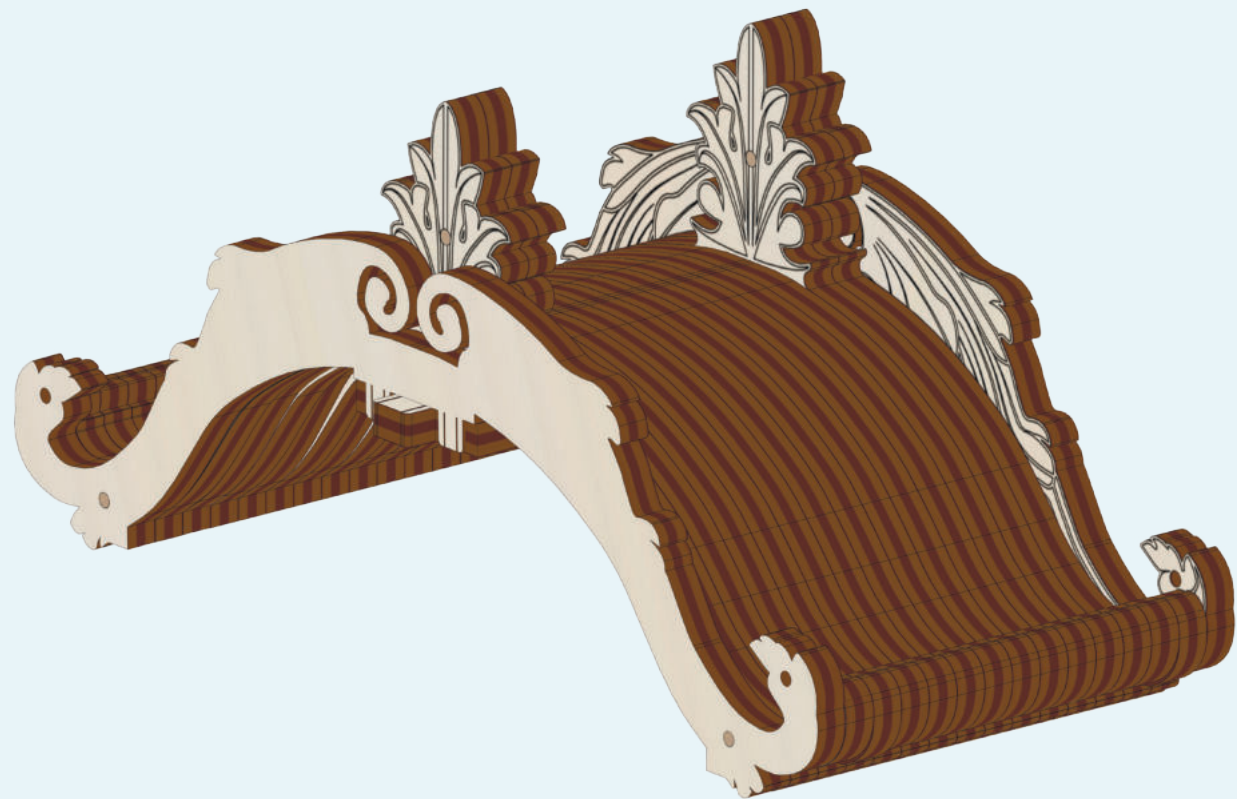

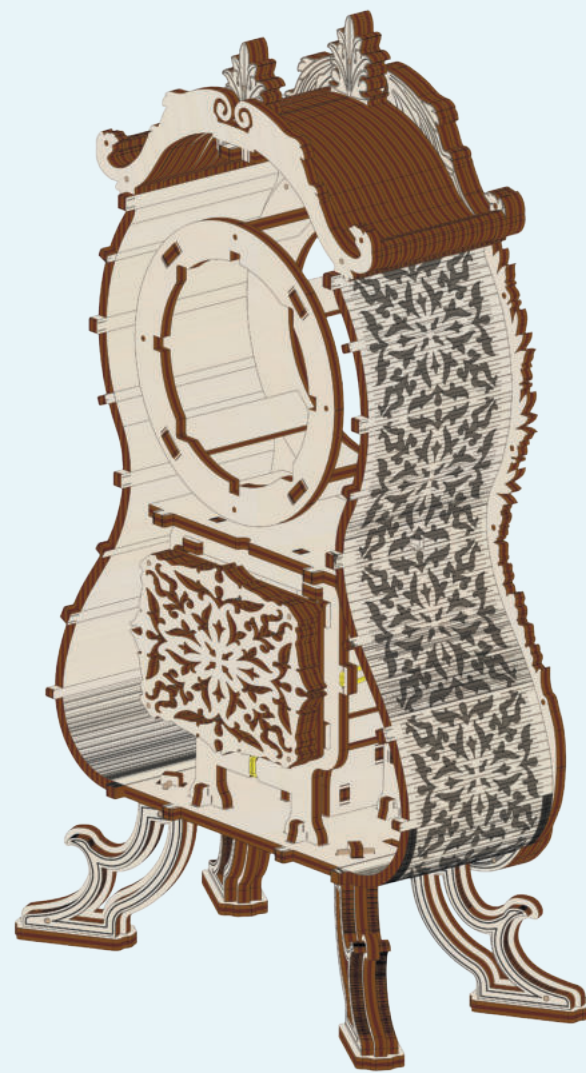
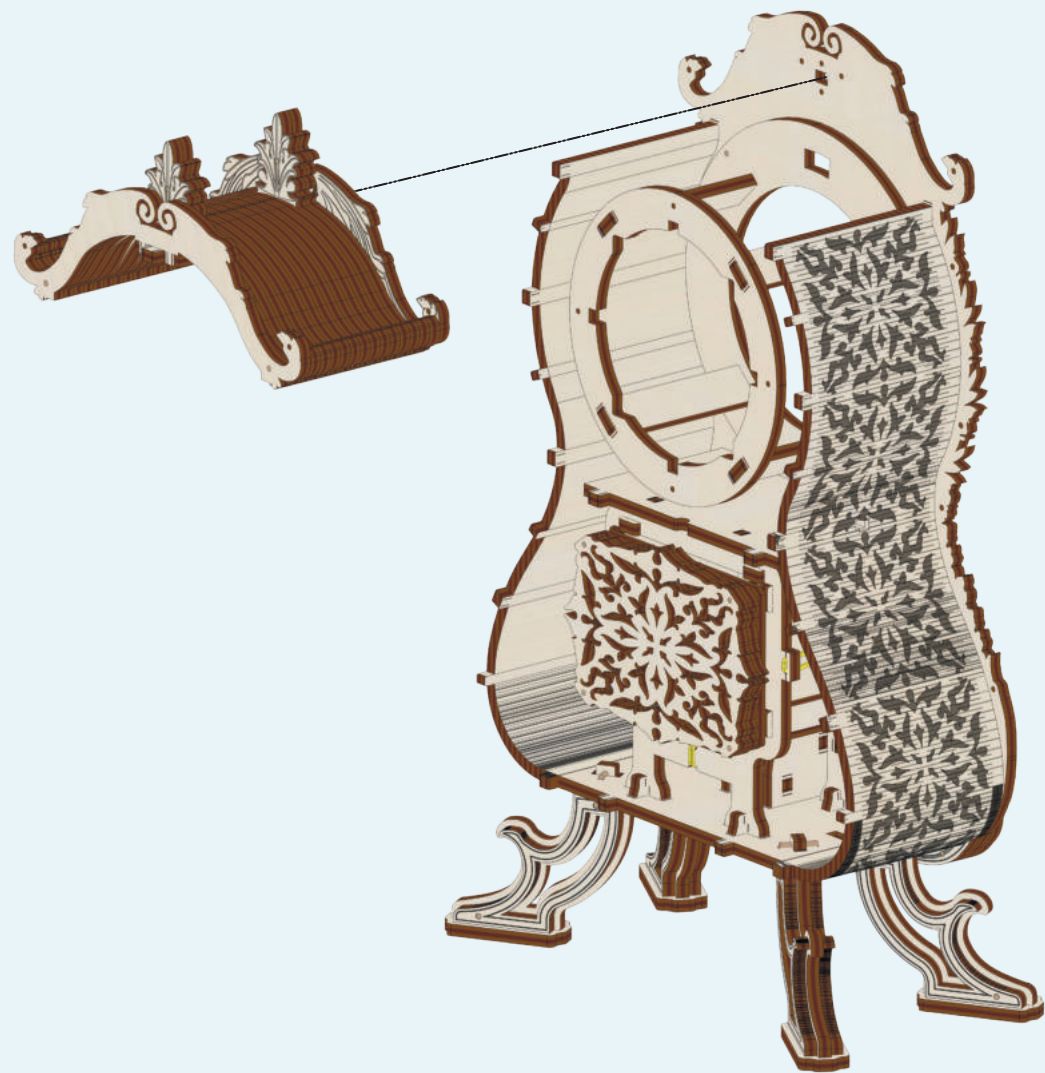

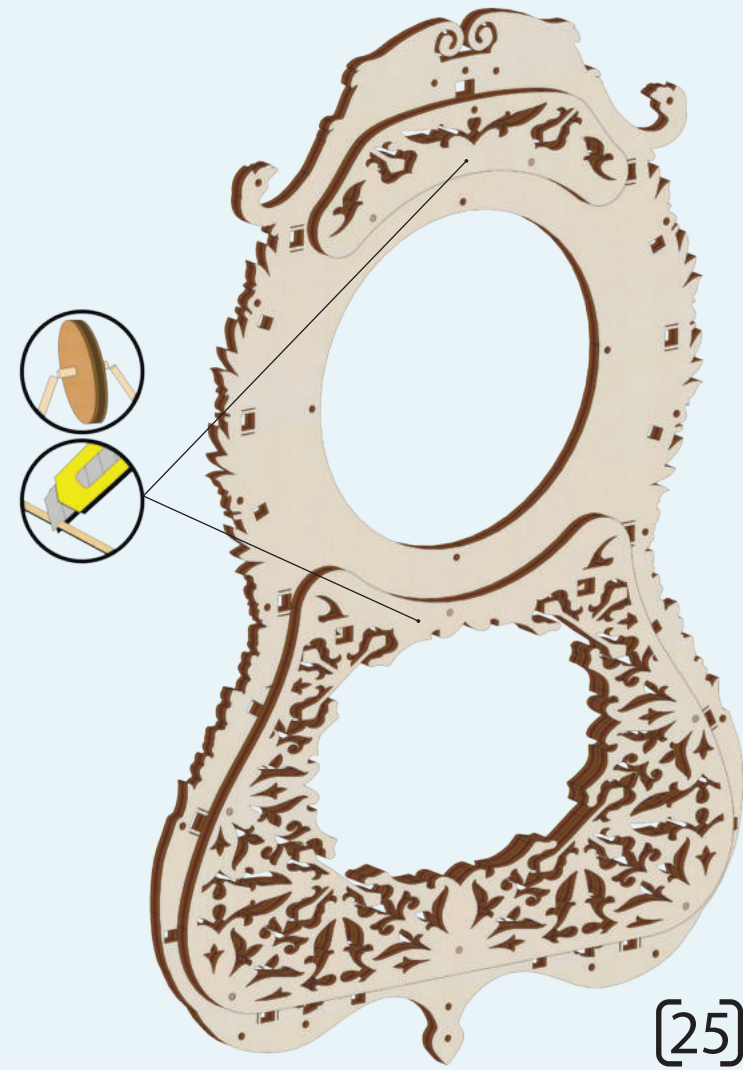
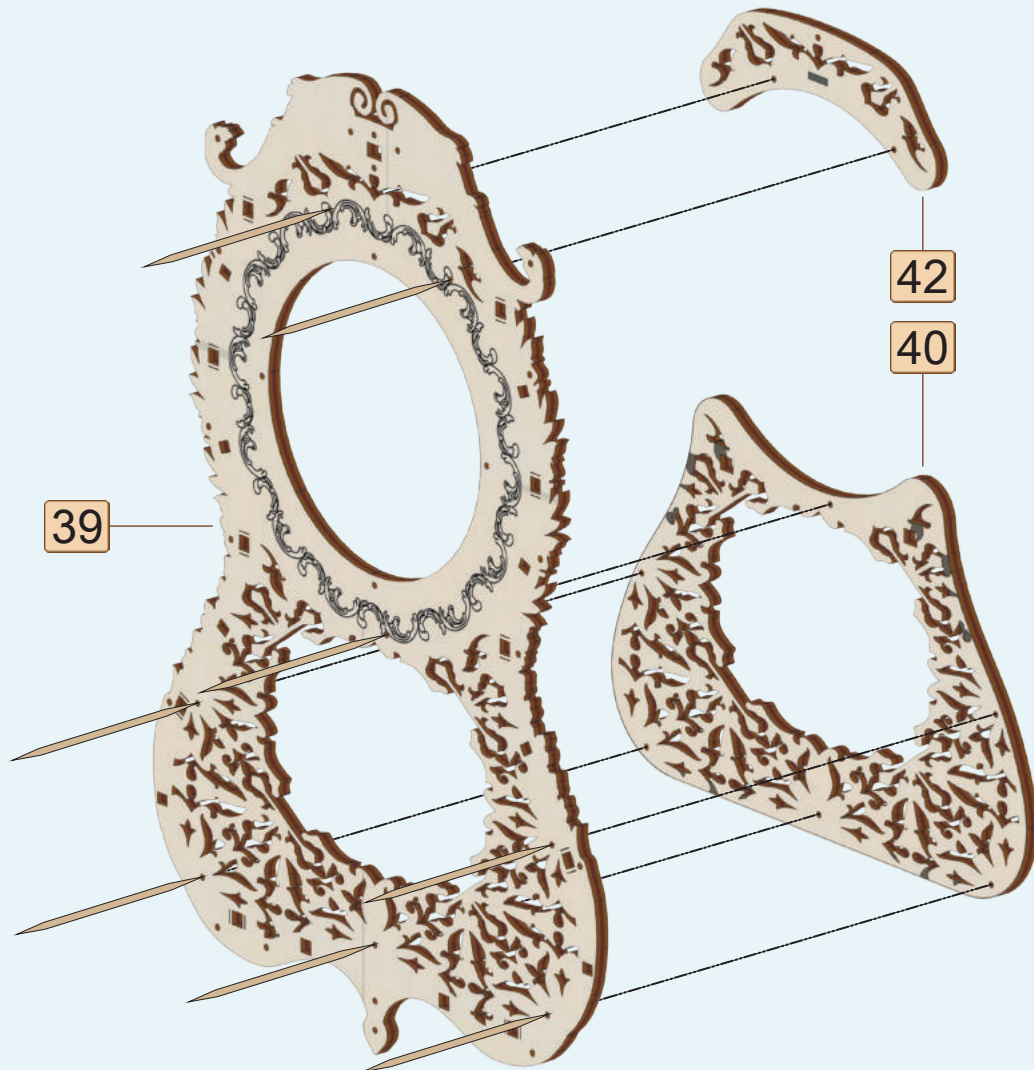
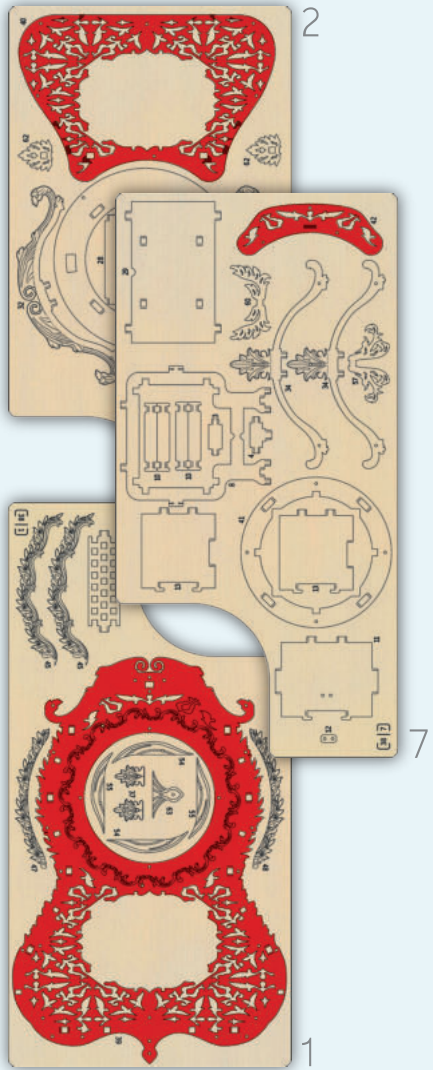

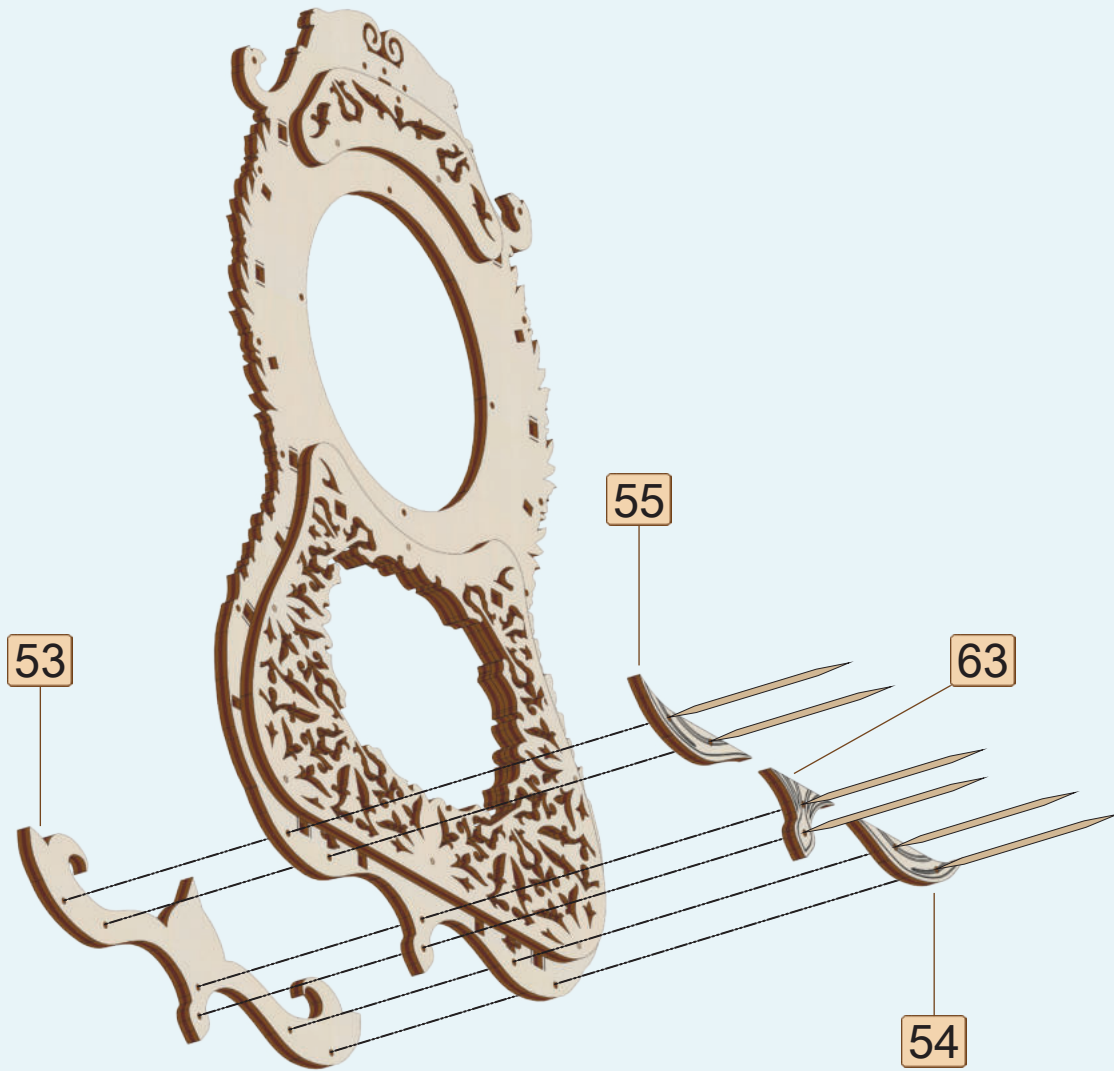
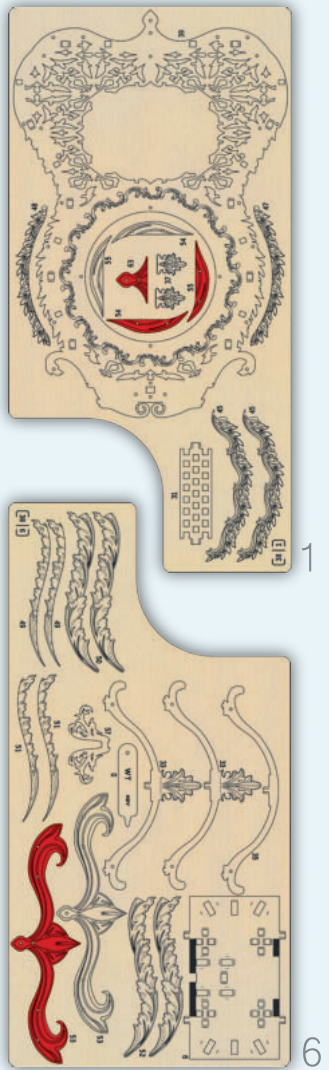

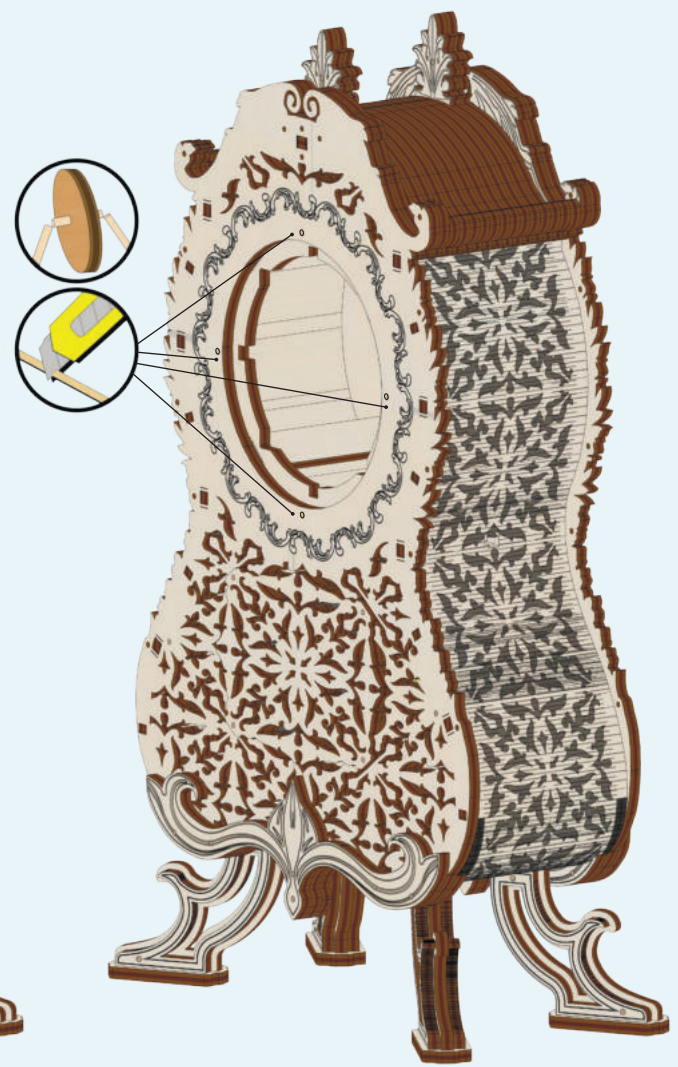
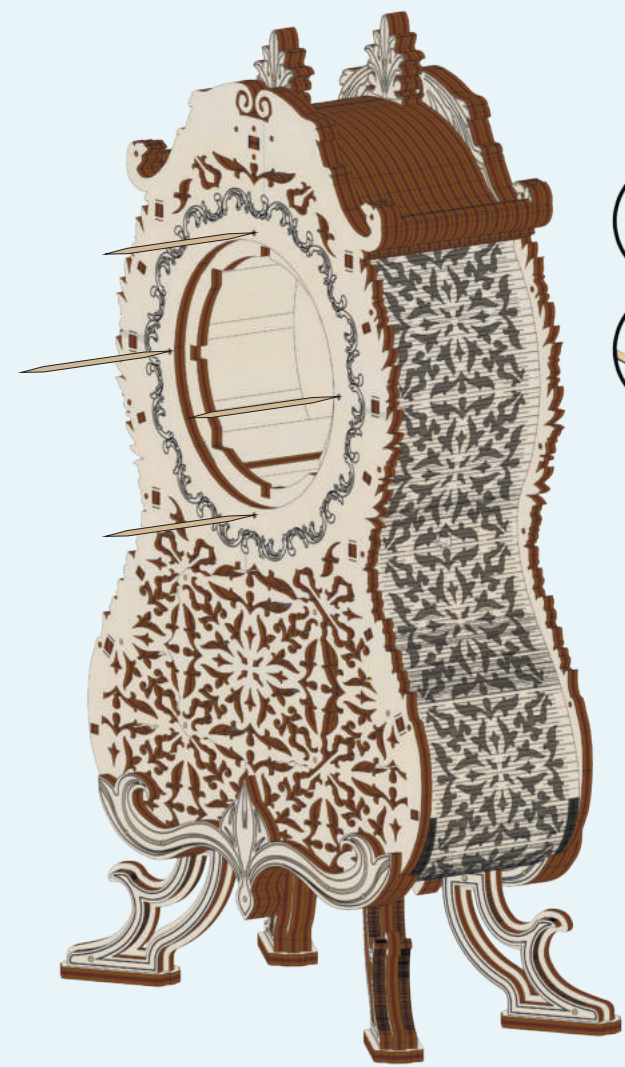
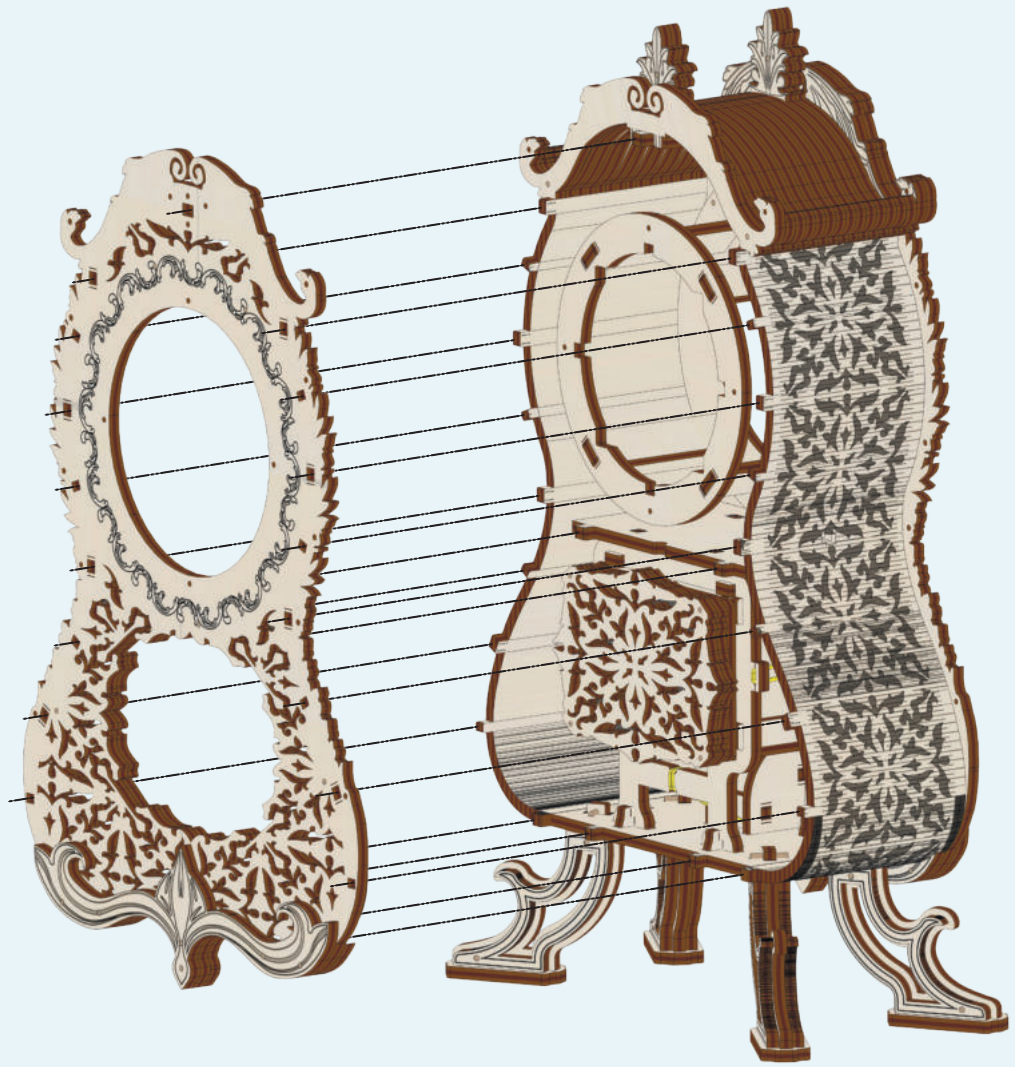

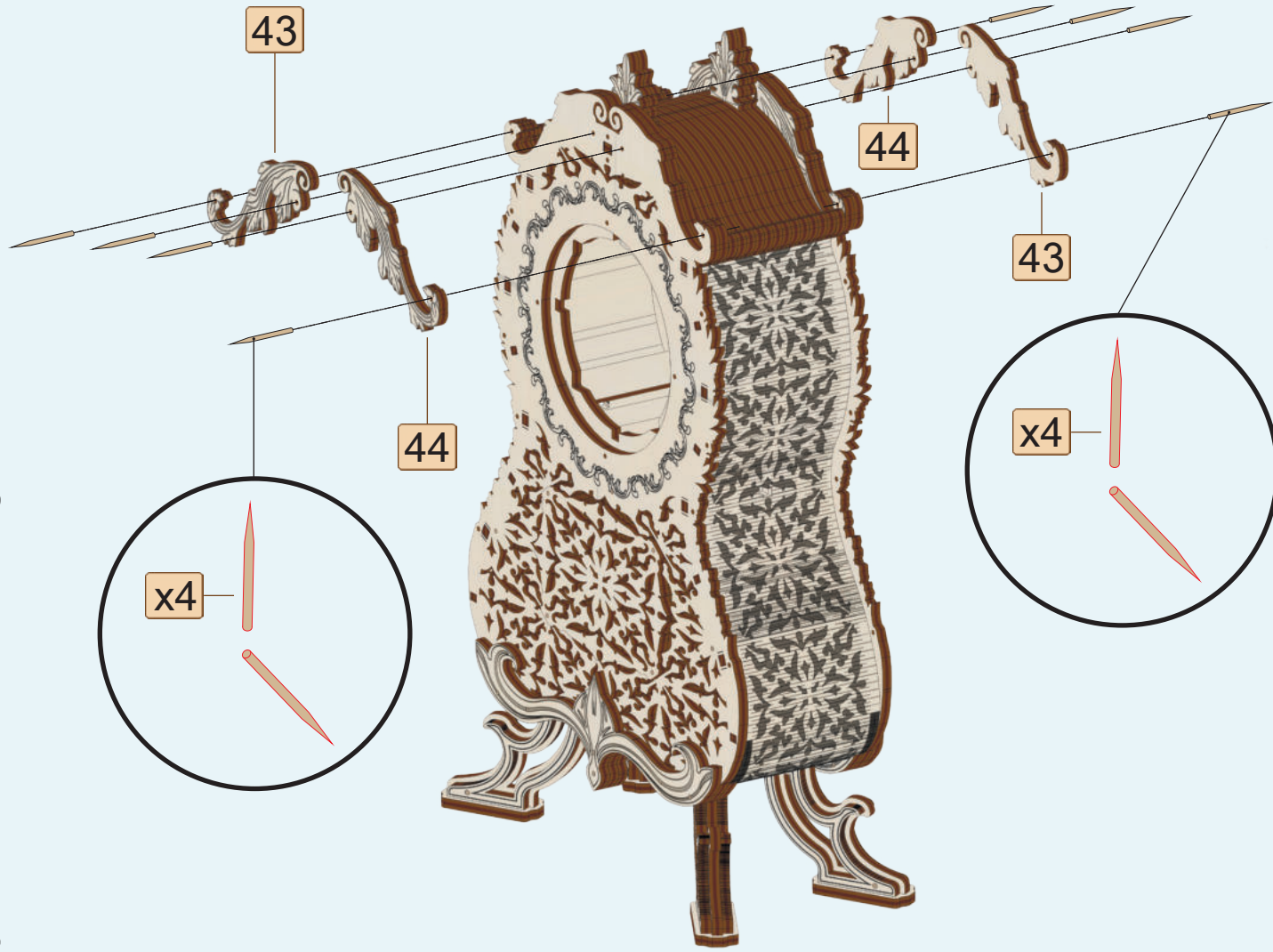
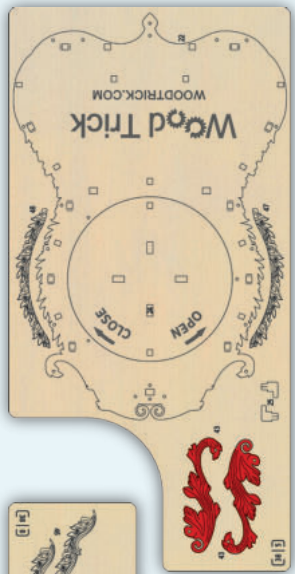

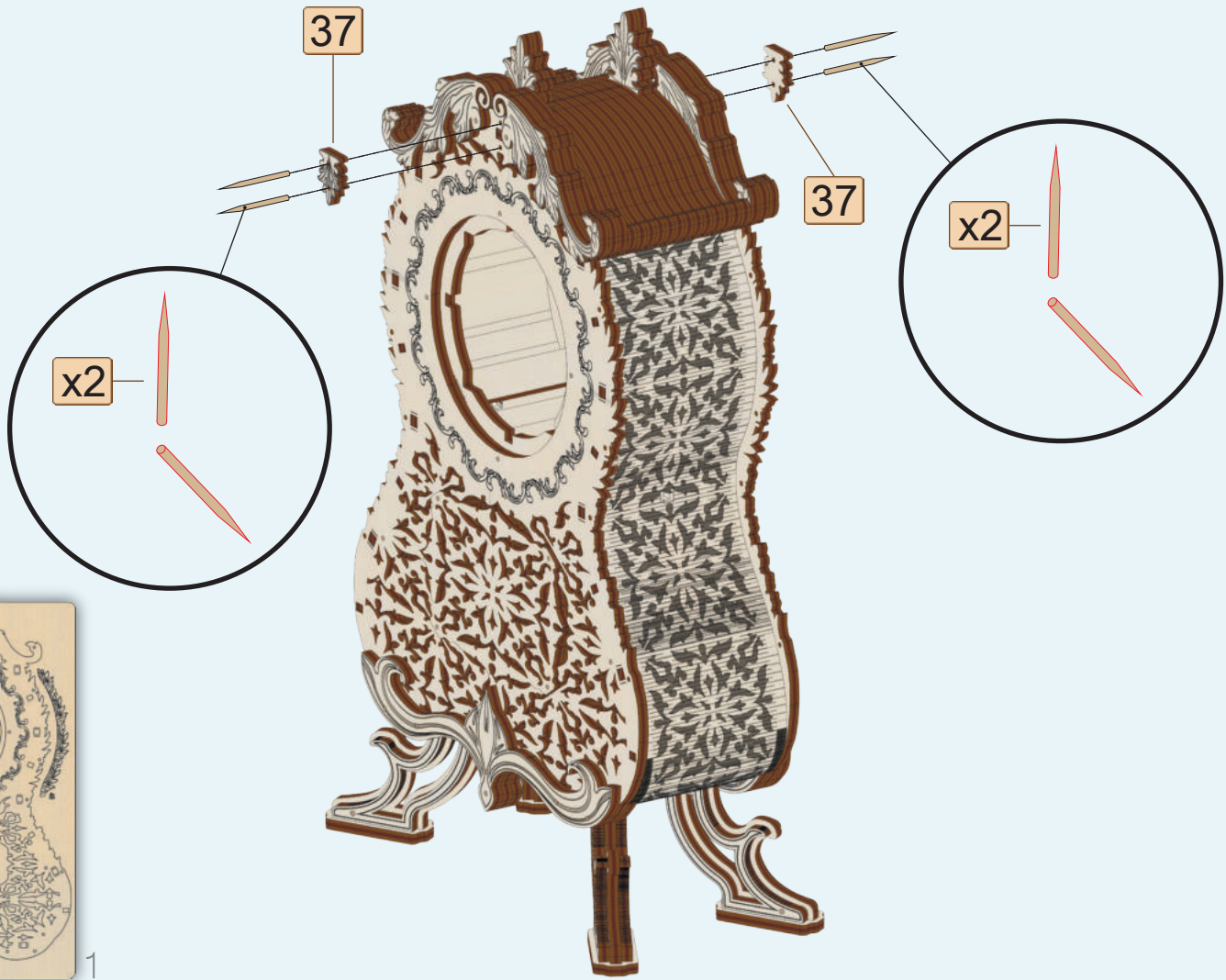

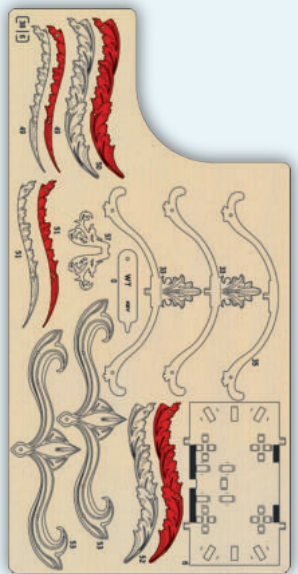

6

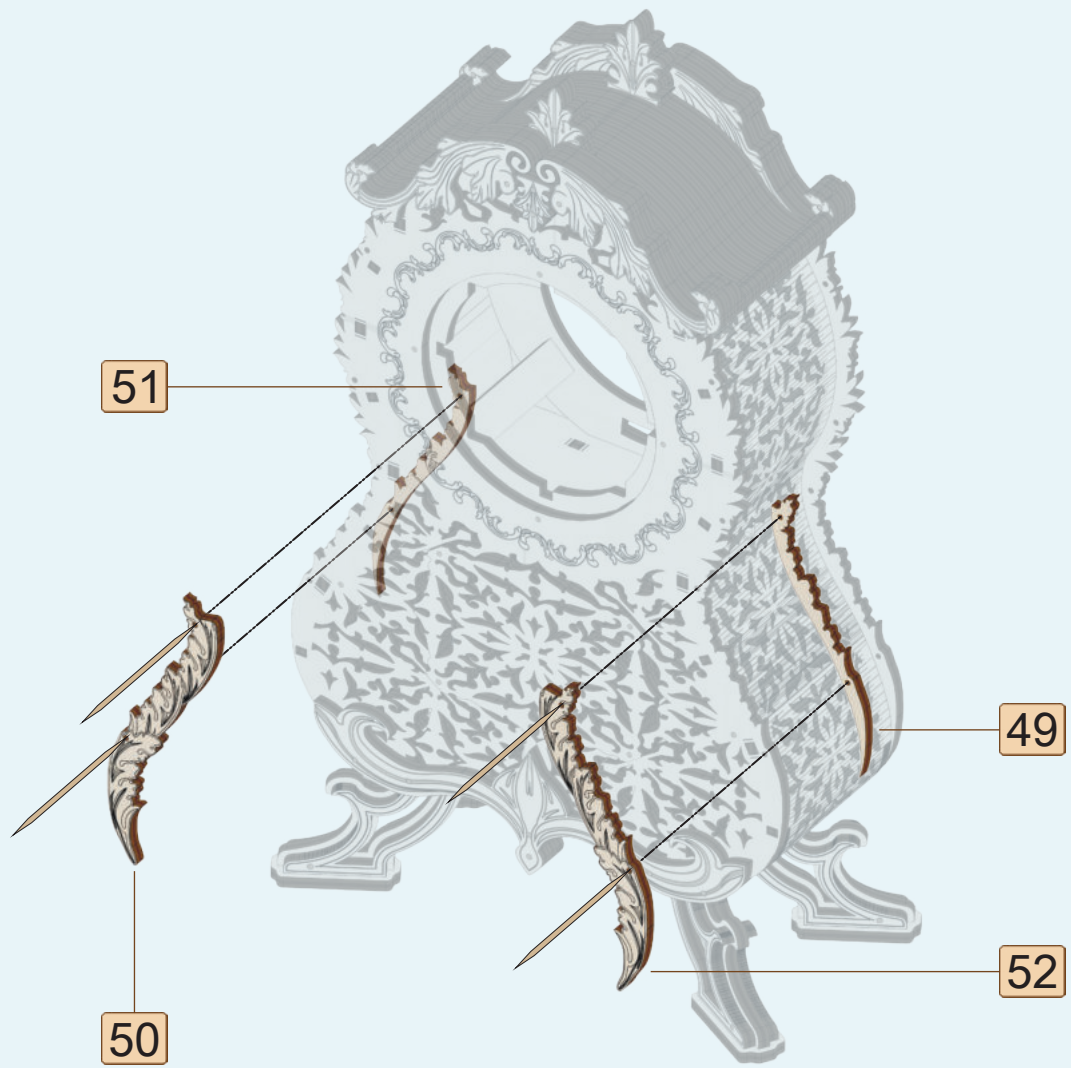

[30]

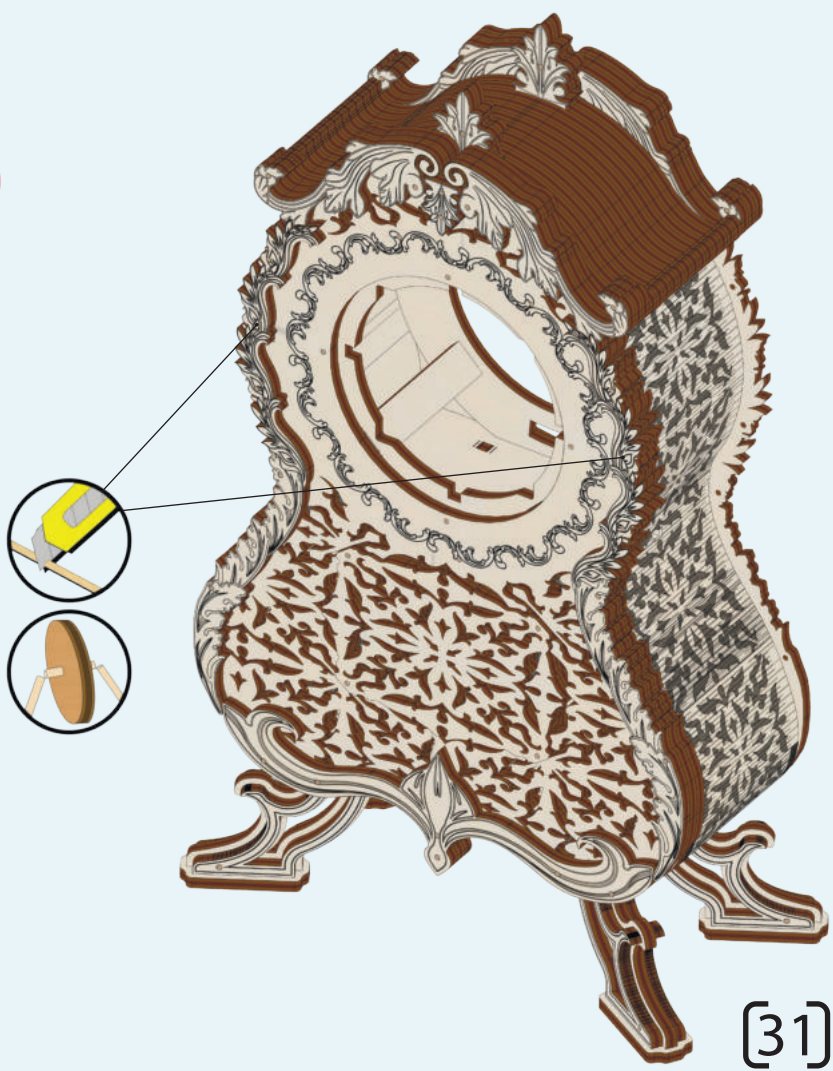
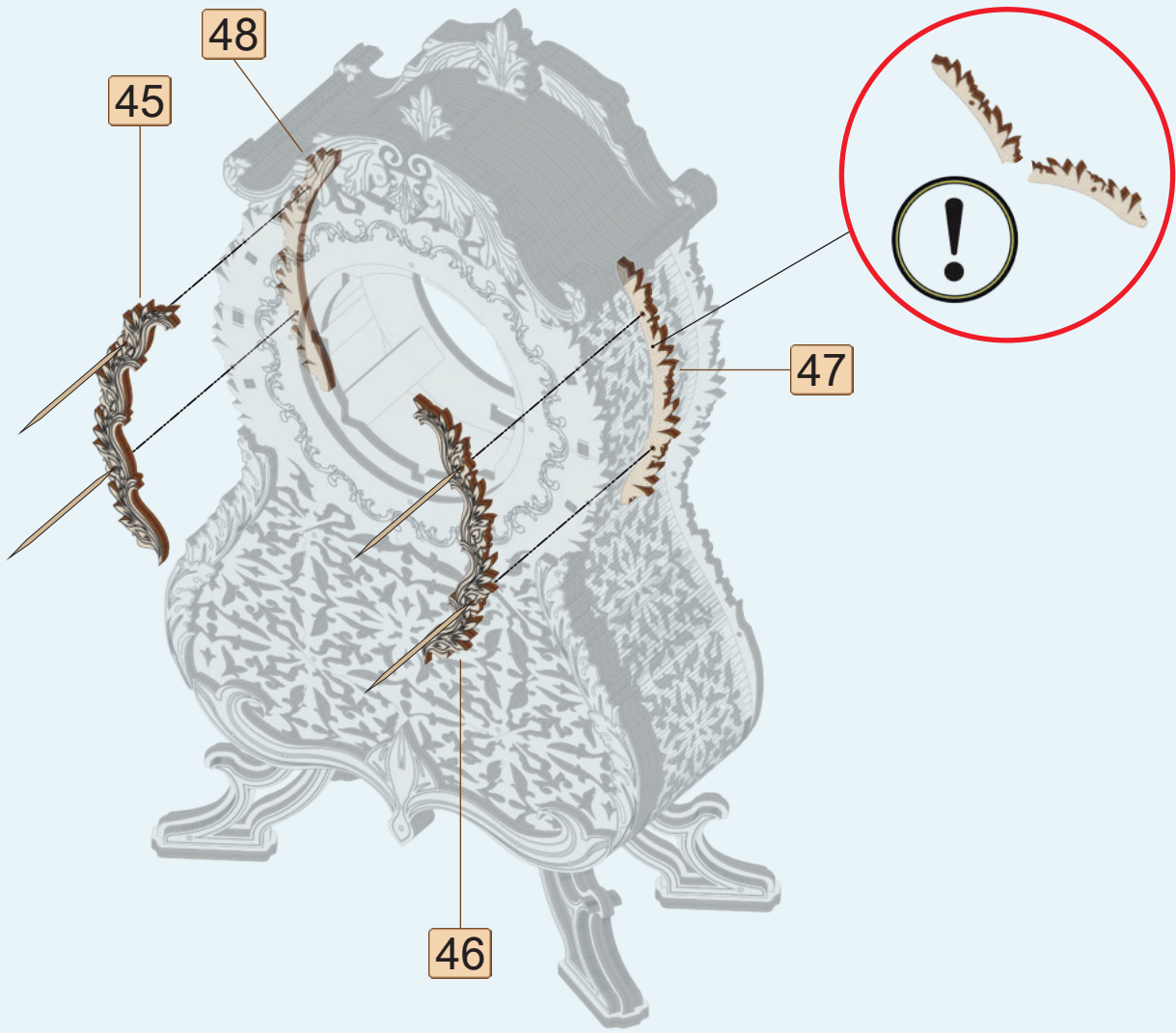
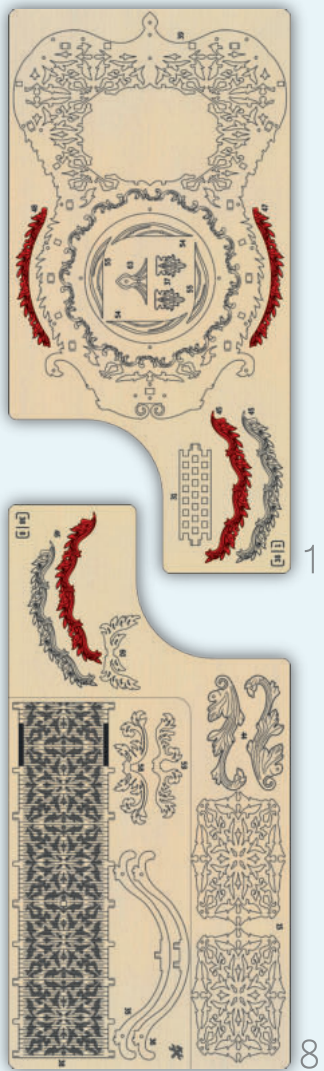

[31]

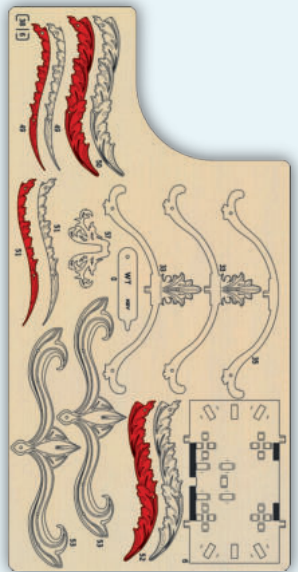

6

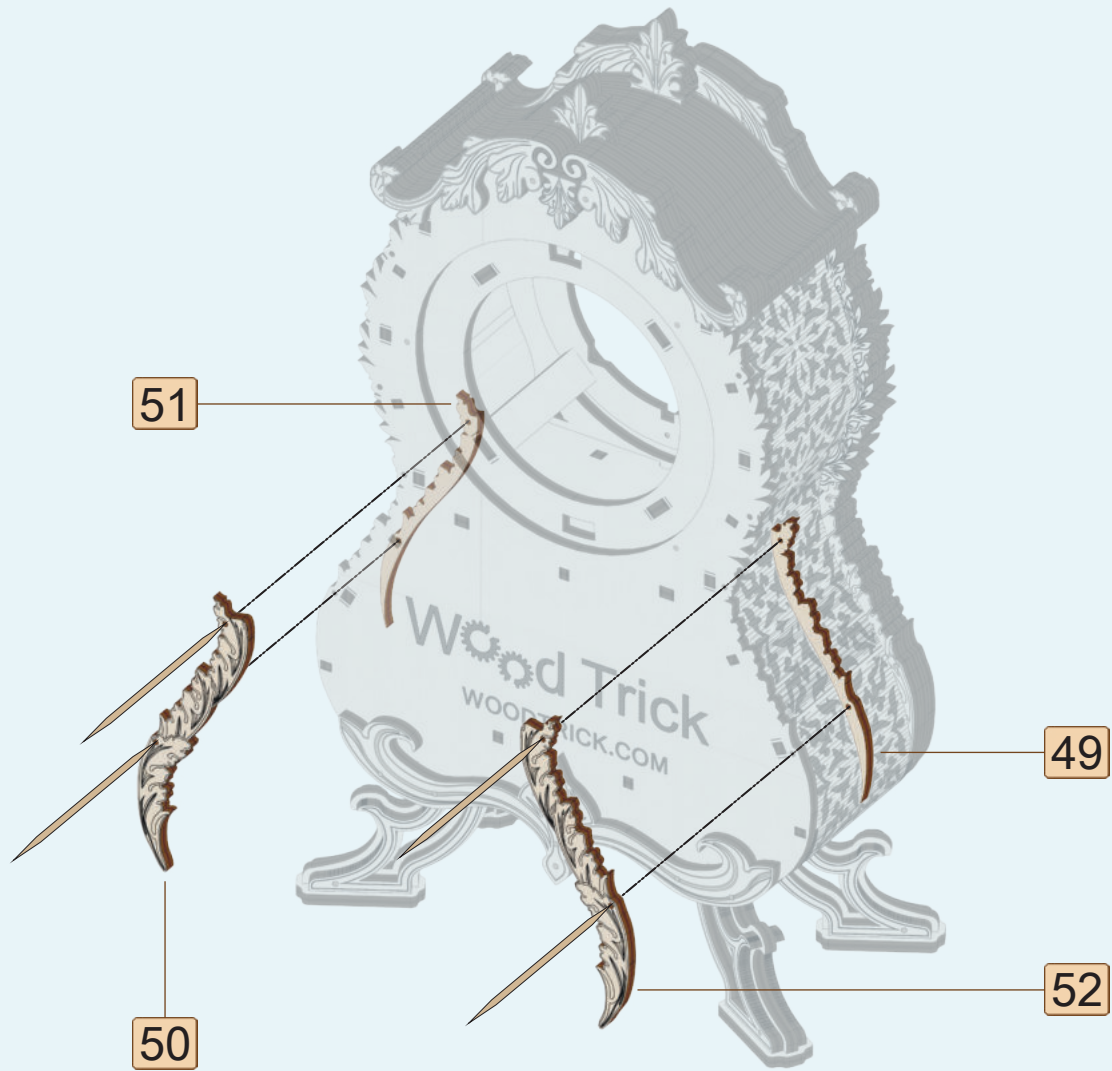

32

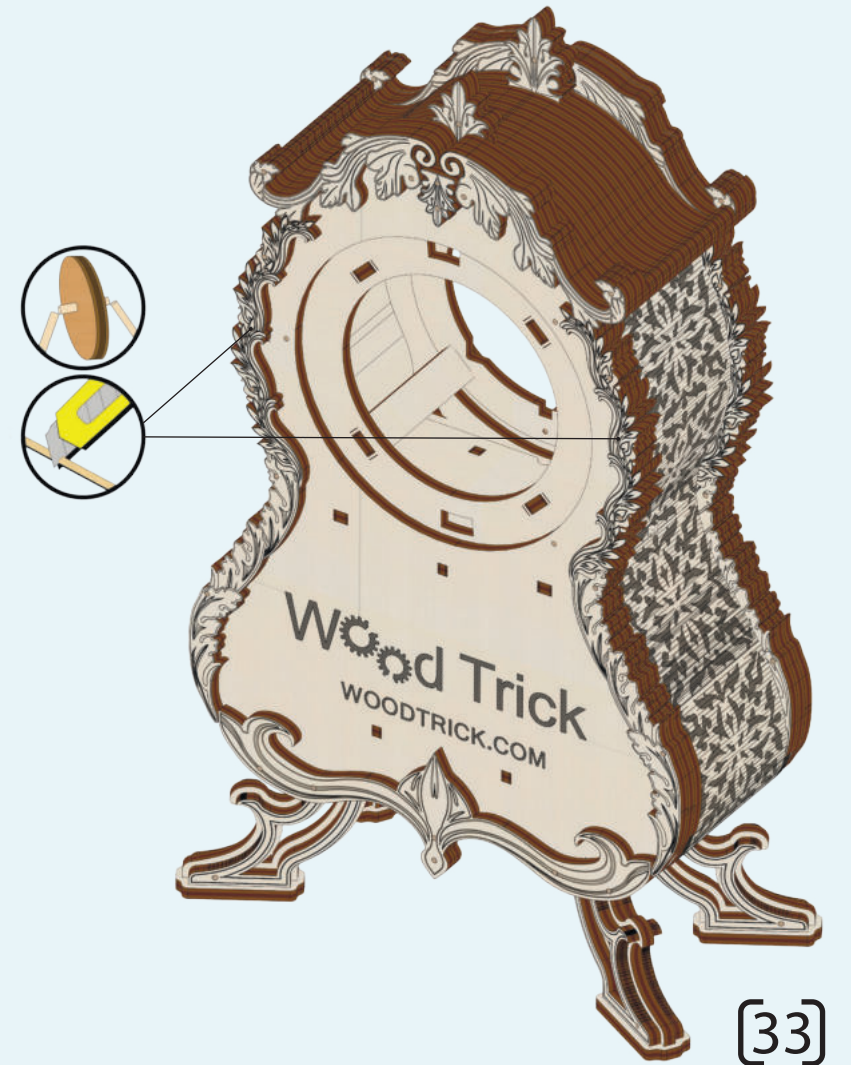
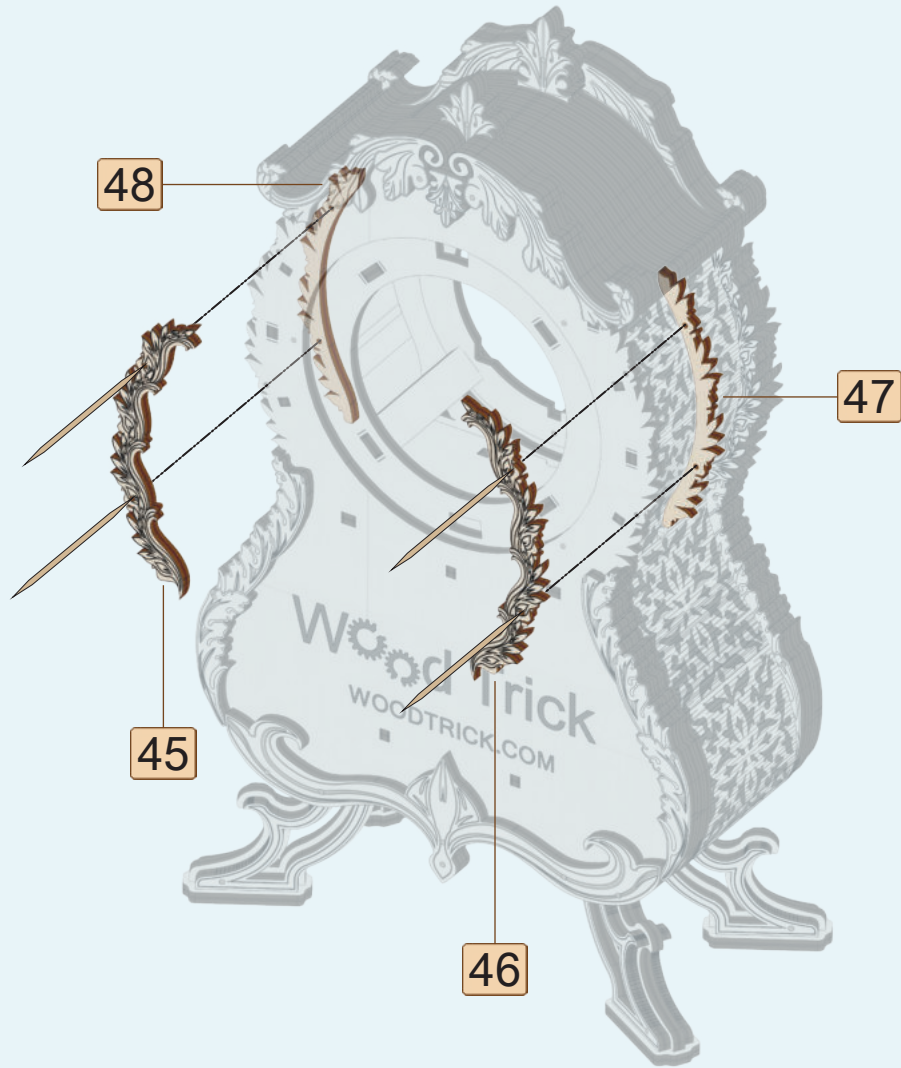

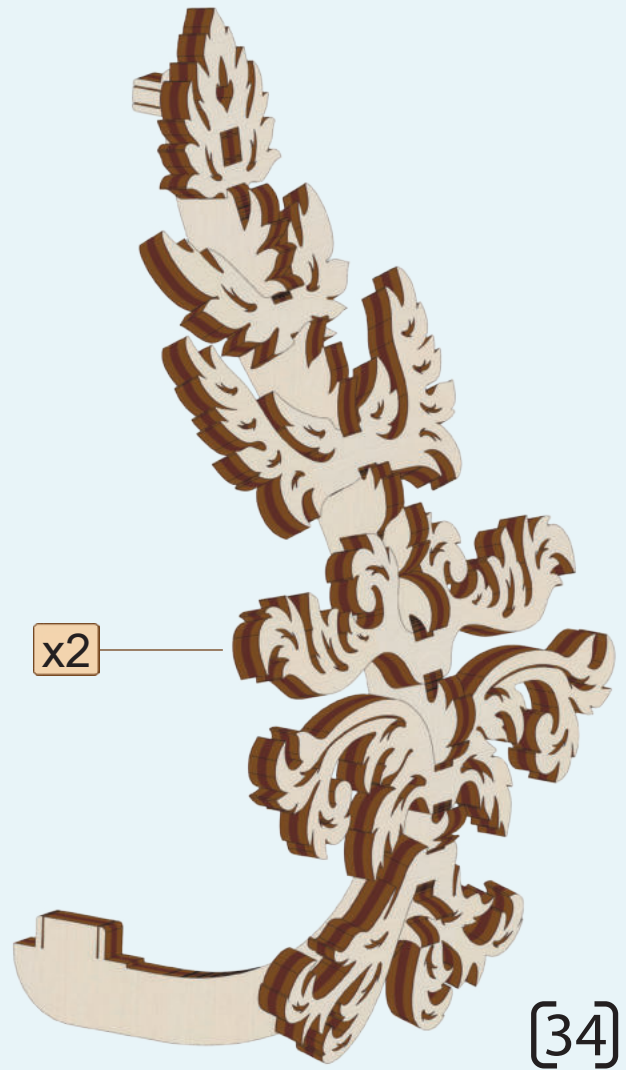
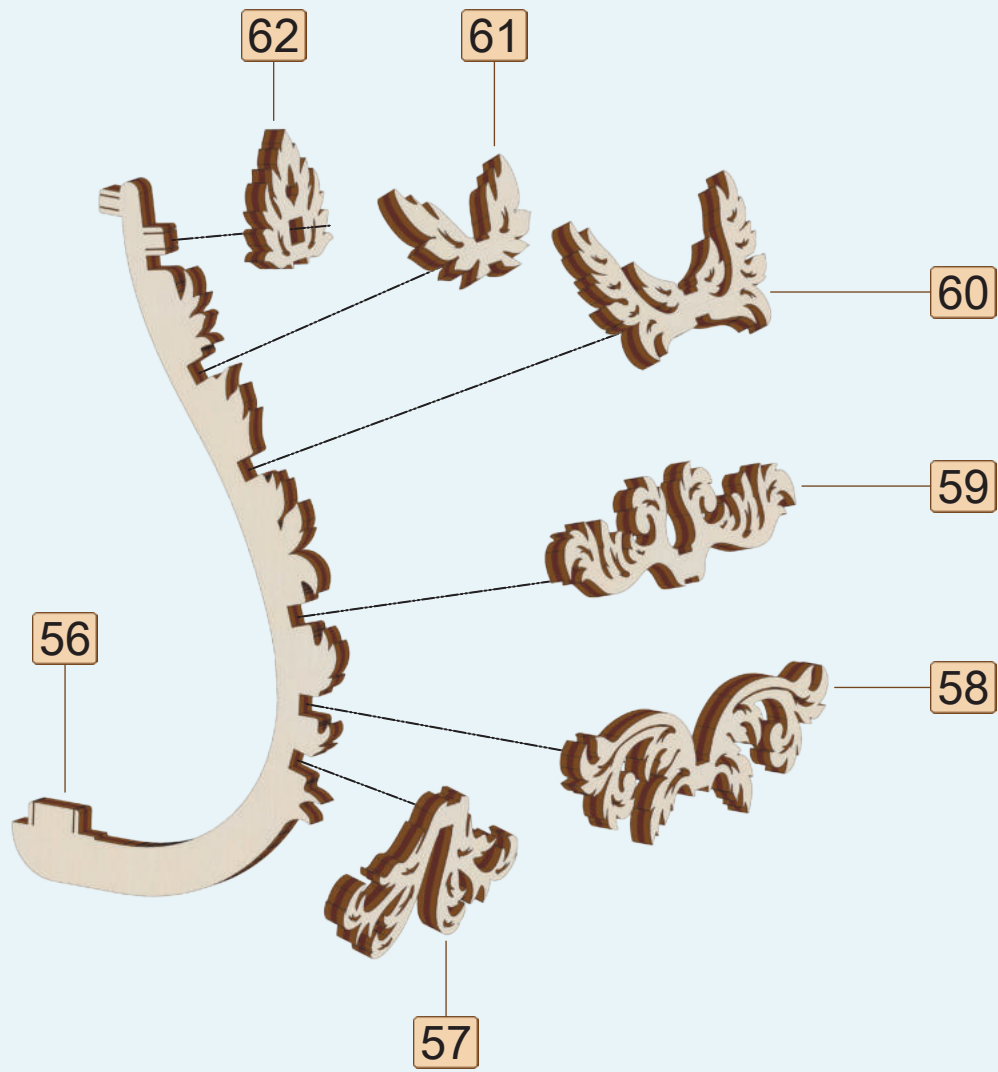
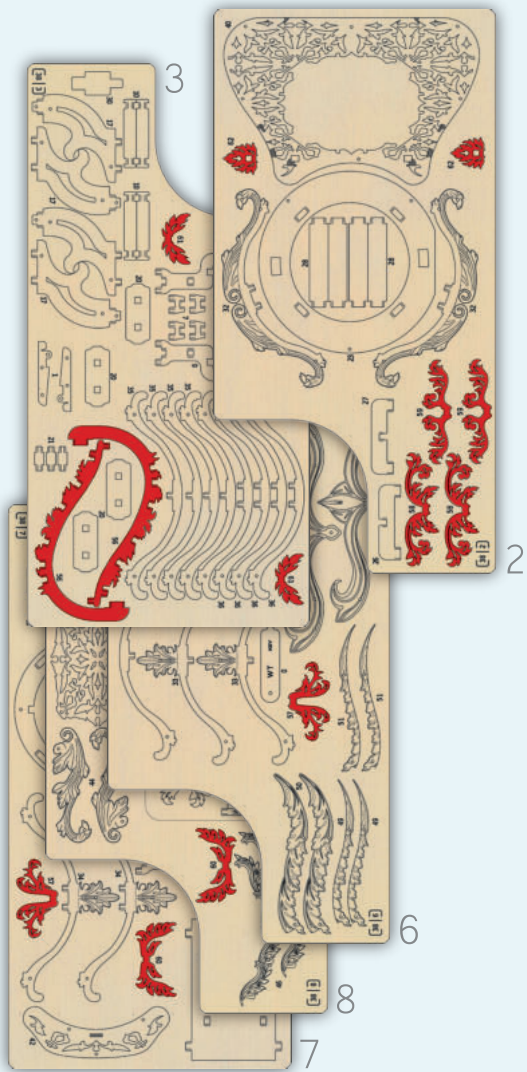

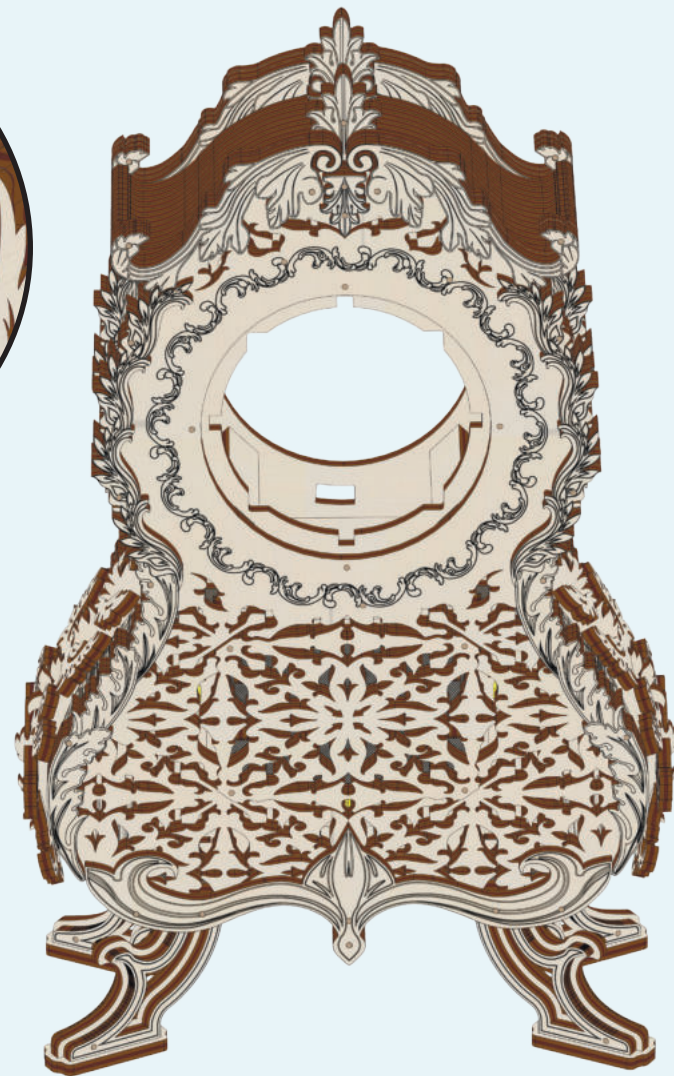
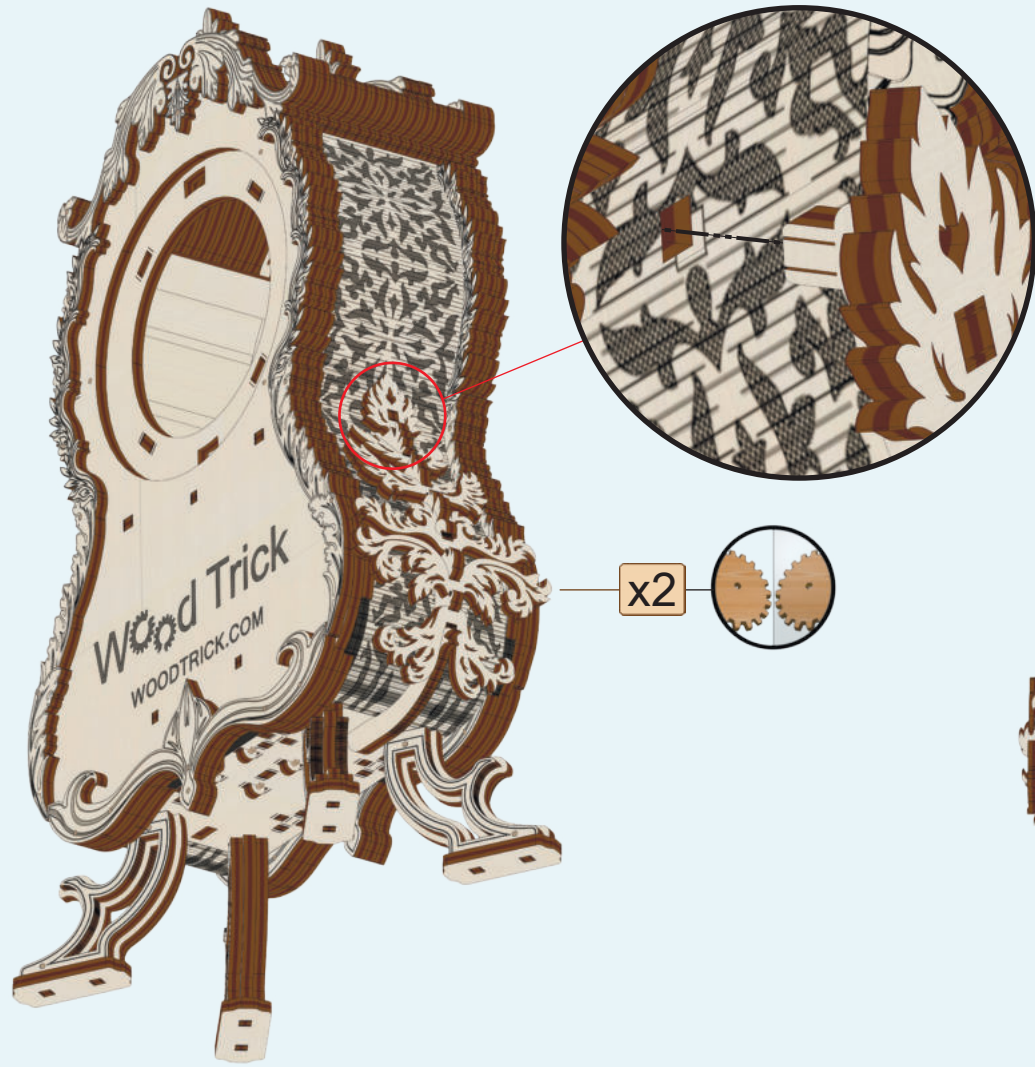

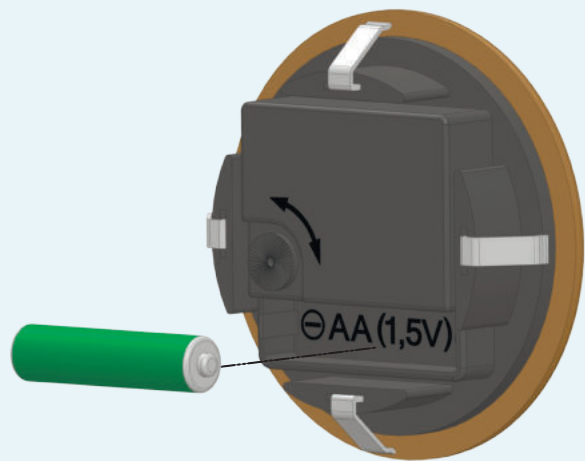

RU Для работы механизма необходимо использовать алкалиновые батарейки типа AA (1,5 В).

UA Для роботи механізму необхідно використовувати батарейки типу AA (1,5 В).

EN For the correct work of the mechanism alkaline AA batteries (1.5 V) must be used.

FR Pour que le mécanisme fonctionne, vous devez utiliser des piles alcalines AA (1,5 V).

ITL Affinché il meccanismo funzioni, è necessario utilizzare batterie alcaline AA (1,5 V).

DE Damit der Mechanismus funktioniert, müssen AA-Alkalibatterien (1,5 V) verwendet werden.

PL Aby mechanizm działał, należy stosować alkaliczne baterie AA (1,5 V).

SP Para que el mecanismo funcione, se deben usar baterías alcalinas AA (1.5 V).

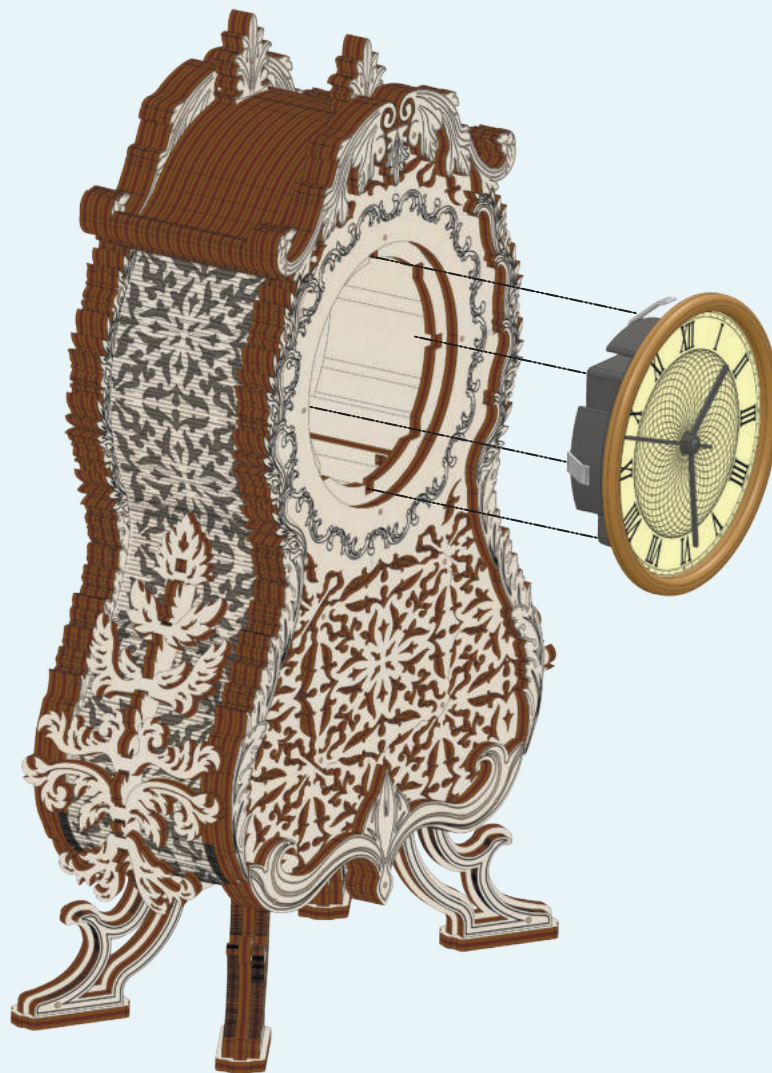



2

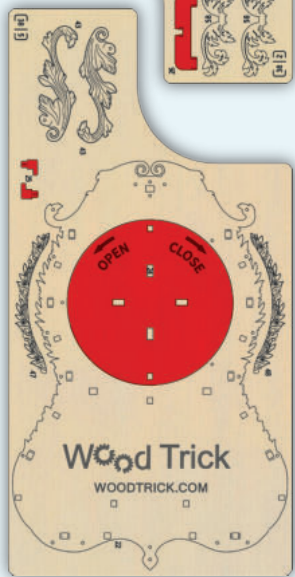

5

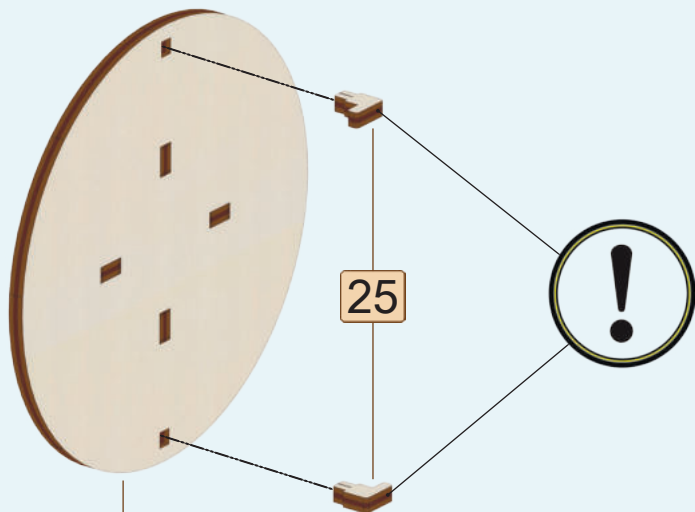

24

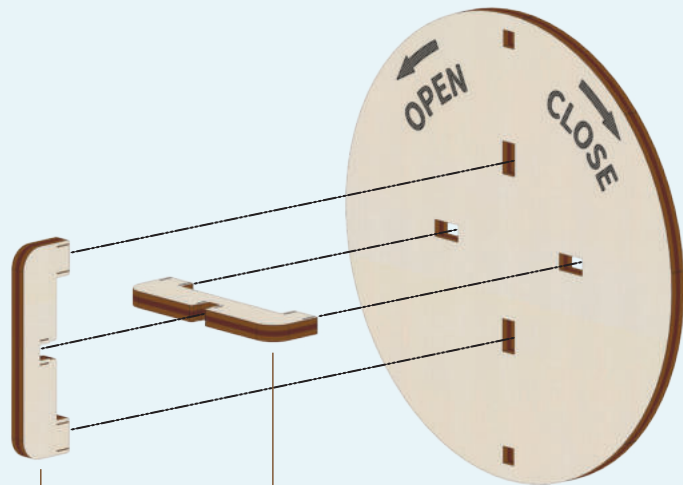
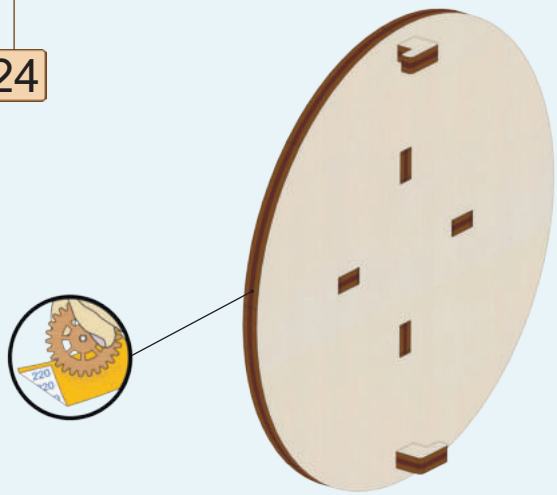

27

26



[37]

