



# CLASSIC

11014



 **WARNING: CHOKING HAZARD.**  
Small parts. Not for children under 3 years.



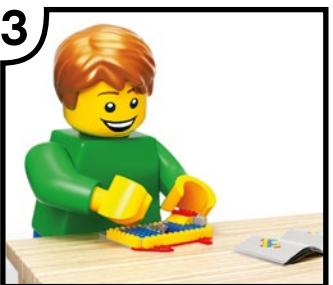

**AVERTISSEMENT : RISQUE D'ÉTOUFFEMENT.**  
Contient des petites pièces. Ne convient pas aux enfants de moins de 3 ans.



**ADVERTENCIA: PELIGRO DE ASFIXIA.**  
No recomendado para niños menores de 3 años. Contiene piezas pequeñas.



- 1** Scan the code on the front cover  
 Scanne den Code auf der Titelseite  
 Scanne le code sur la page de couverture  
 Scanner le code sur la page couverture  
 Scansiona il codice sulla copertina  
 Escanea el código de la portada  
 Faz scan do código na frente da capa  
 Olvasd be a borítón látható kódot!  
 Noskeně kodu uz priekšējā vāka  
 扫描封面上的二维码



- 2** Get Instructions PLUS  
 Hol dir Instructions PLUS  
 Obtens les instructions PLUS  
 Obtenir les Instructions PLUS  
 Scarica Instructions PLUS  
 Descubre Instructions PLUS  
 Obtém Instruções PLUS  
 Szerezd be az Instructions PLUS kiegészítőt!  
 Saņem "Instructions PLUS"  
 获取更多说明

**LEGO.com/apps**

Check for compatibility  
 Kompatibilität prüfen  
 Vérifier la compatibilité  
 Controlla la compatibilità  
 Comprueba tu compatibilidad

Verificar a compatibilidade  
 Ellenőrizd a kompatibilitást  
 Pārbaudīt saderību  
 检查兼容性



p./pag.  
**11**

p./pag.  
**7**



p./pag.  
**22**





p./pag.  
**31**



p./pag.  
**39**



p./pag.  
**46**



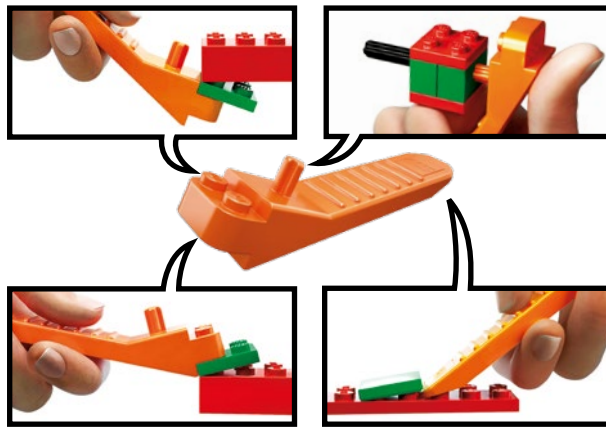

[LEGO.com/brickseparator](https://LEGO.com/brickseparator)

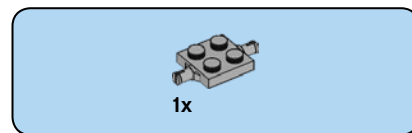
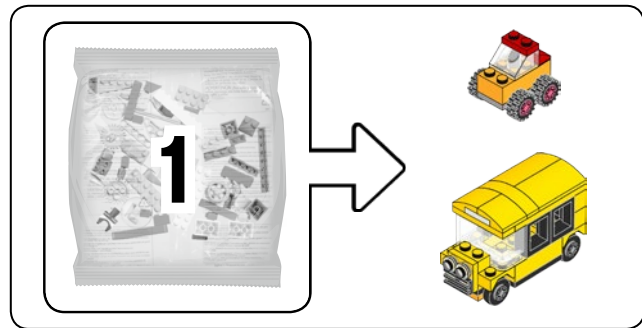

1

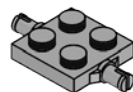

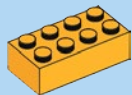

1x

2

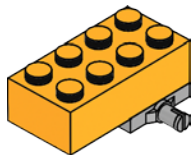

1x

3

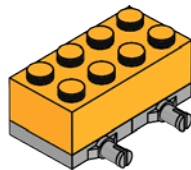



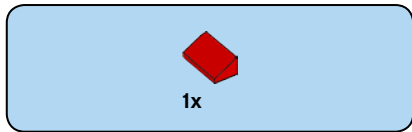

4

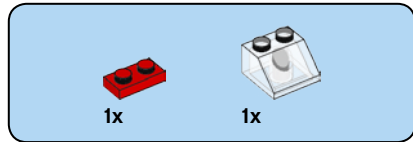
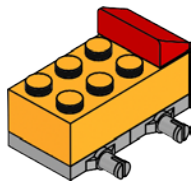

5

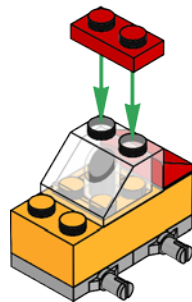

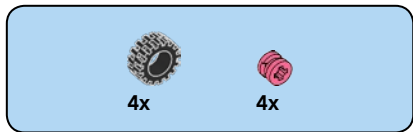

6

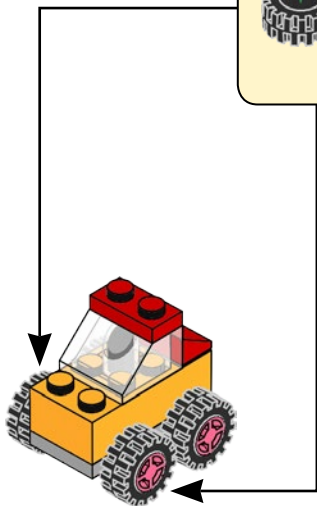
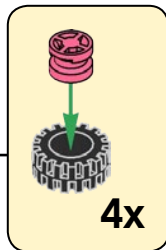

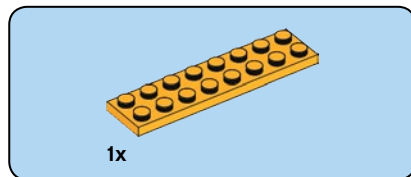

1

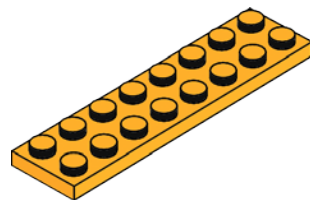

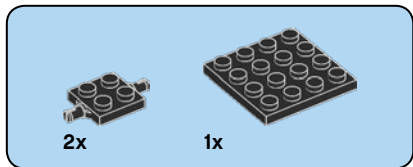

2

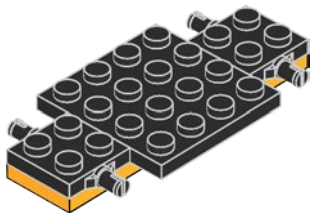

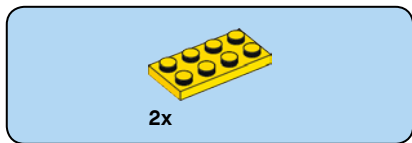

3

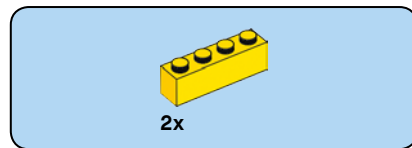
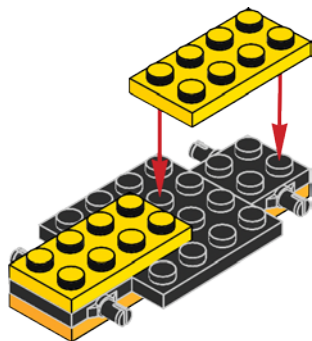

4

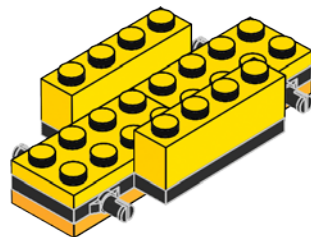

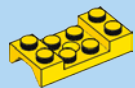

2x

5

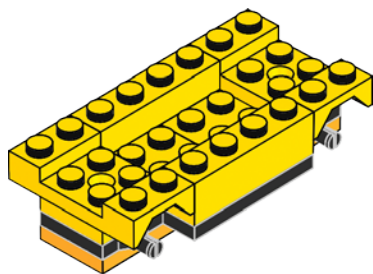



2x



1x

6

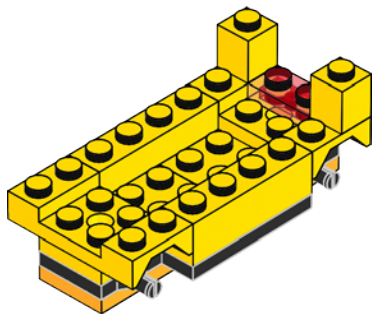

2x



1x

7

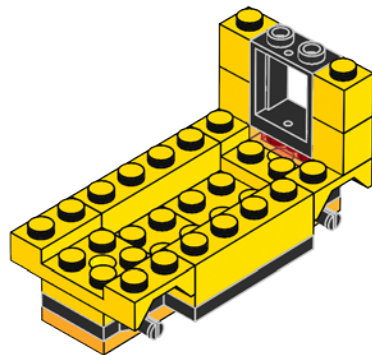



4x

8

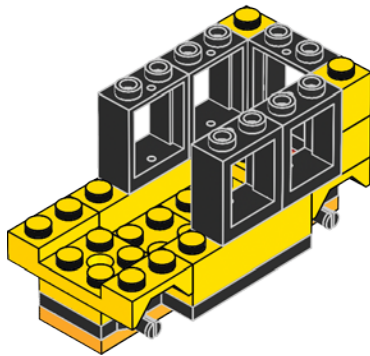



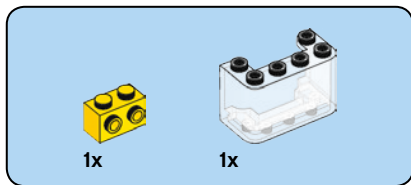

9

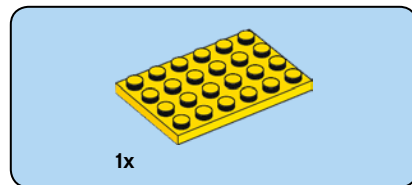
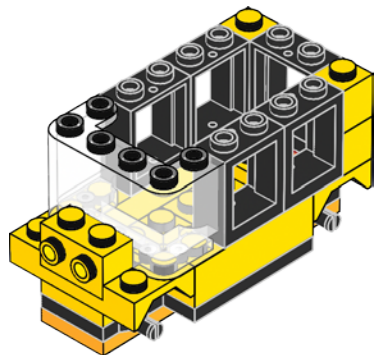

10

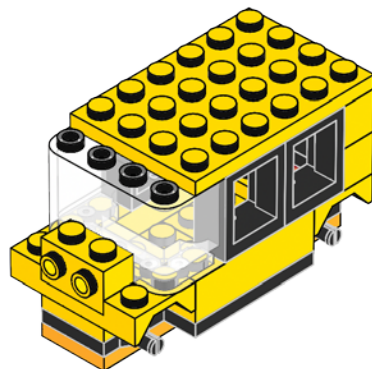



1x

11

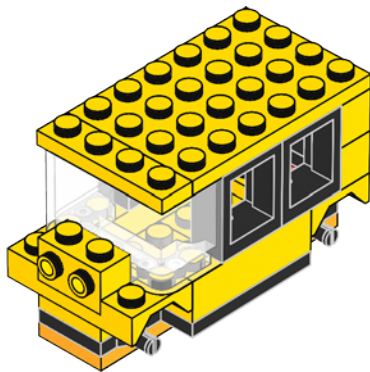

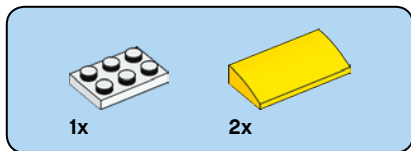

12

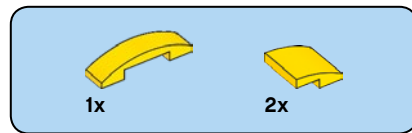
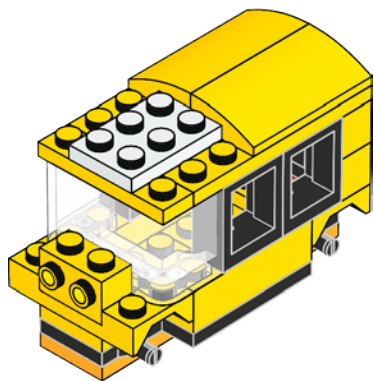

13

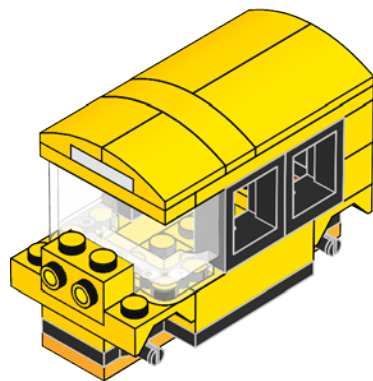



1x

14

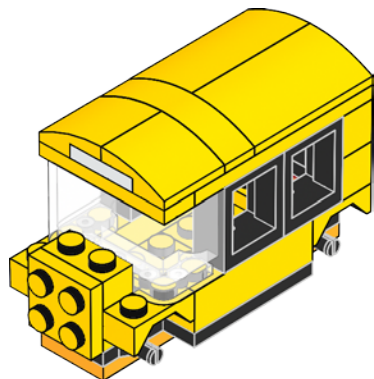

1x



2x

15

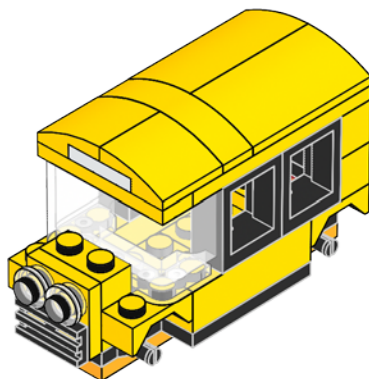



4x



4x

16



4x

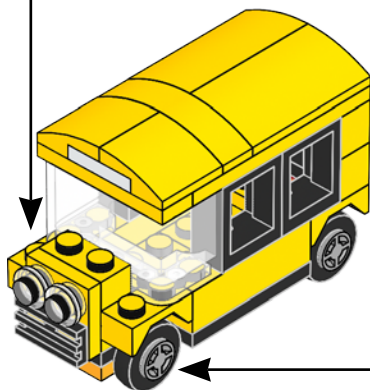

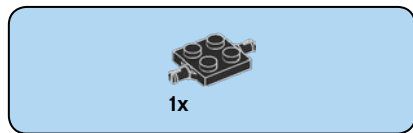
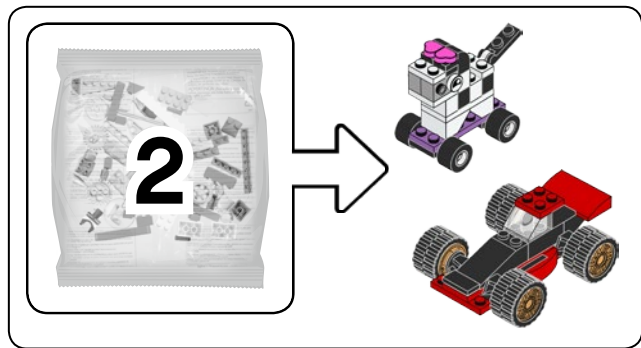

1



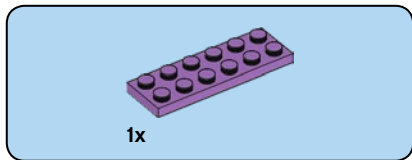

**2**

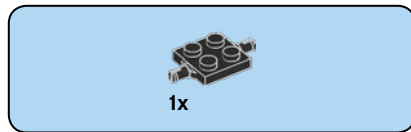
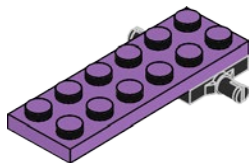

**3**

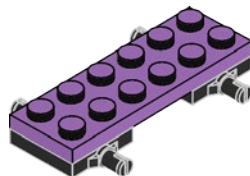



2x

4

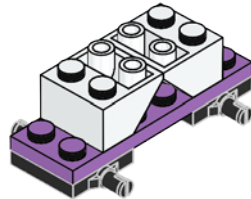



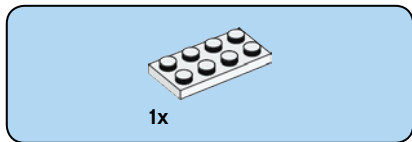

5

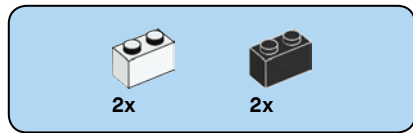
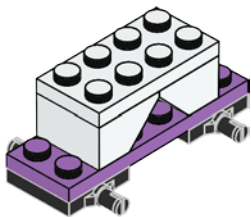

6

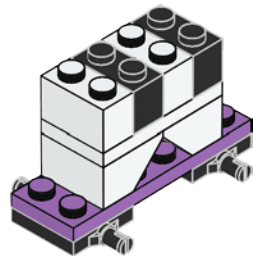

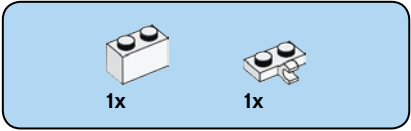

7

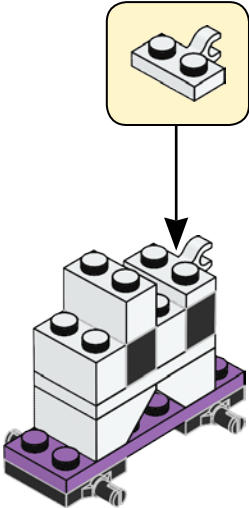

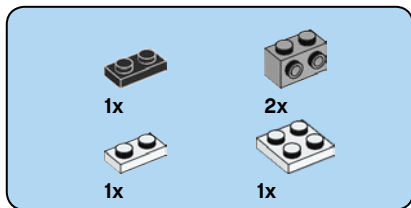

8

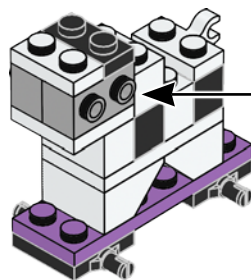
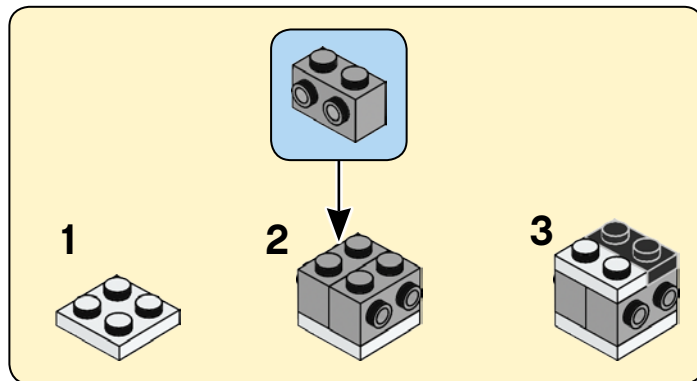



2x

9

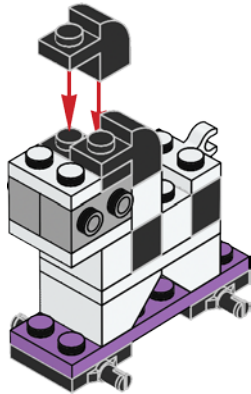

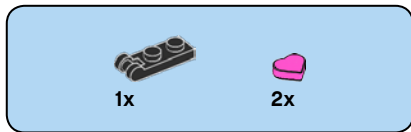

10

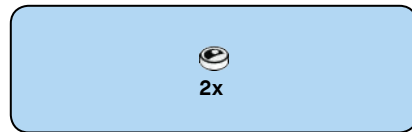
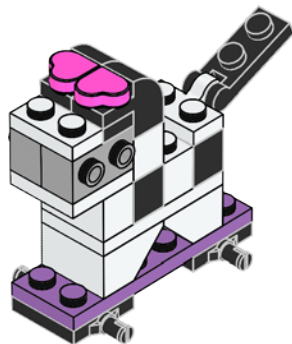

11

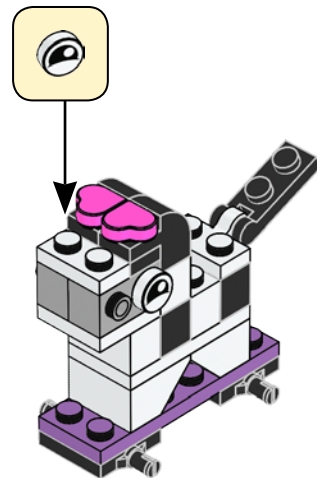

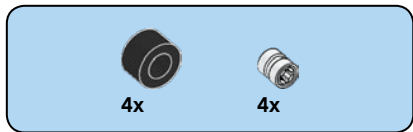

12

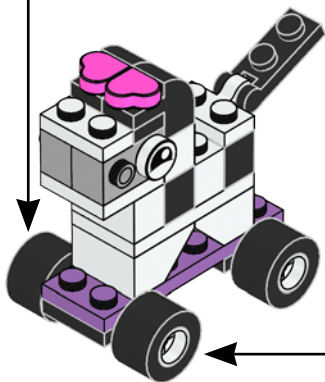
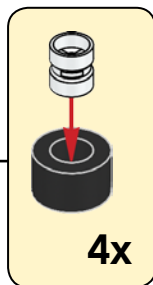

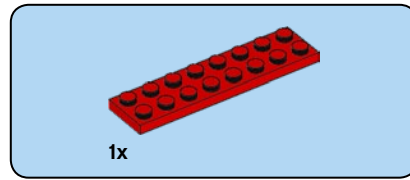

1

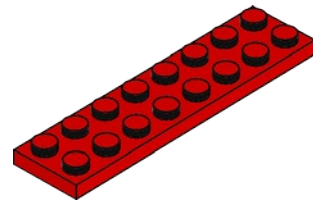

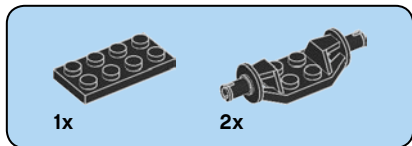

2

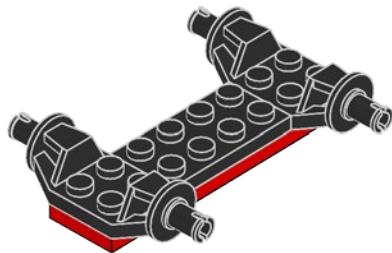



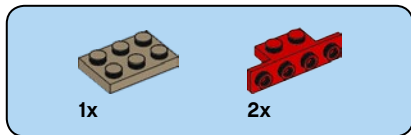

3

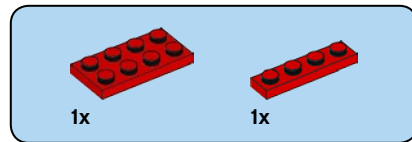
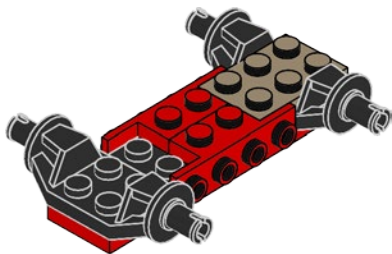

4

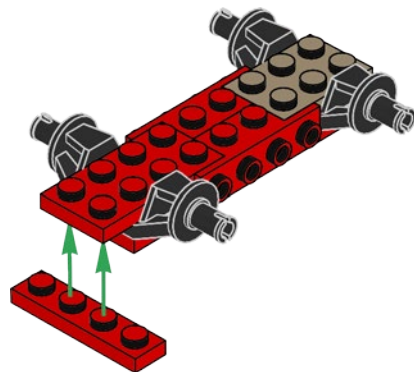

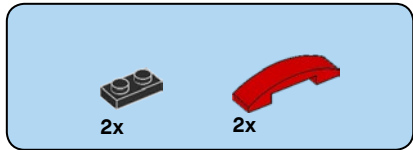

5

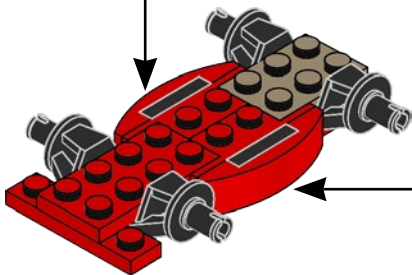
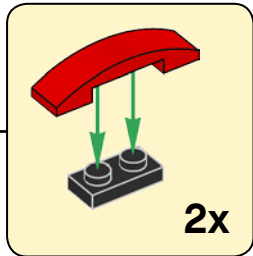

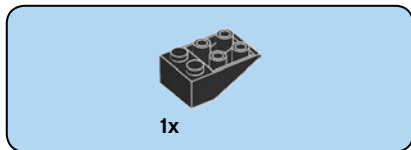

6

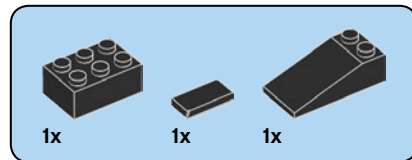
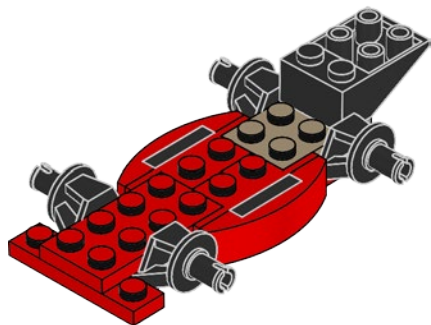

7

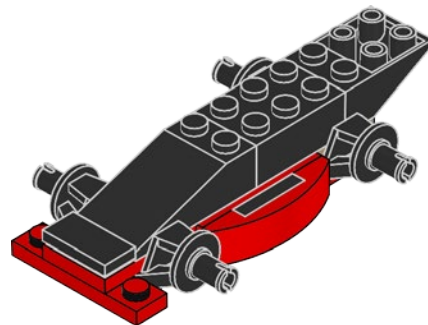



1x



1x

8

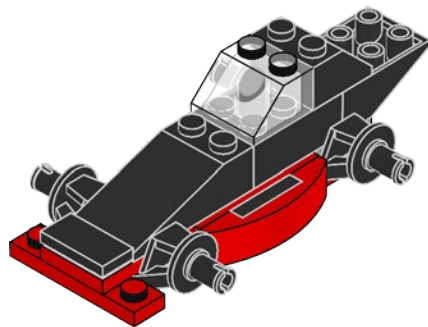

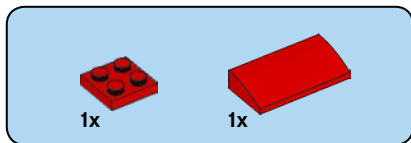

9

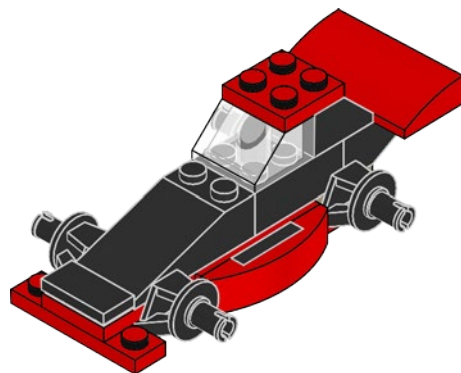

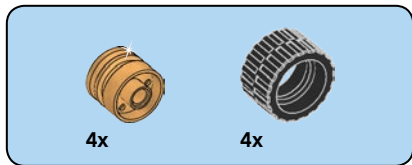

10

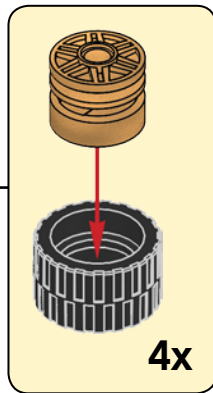
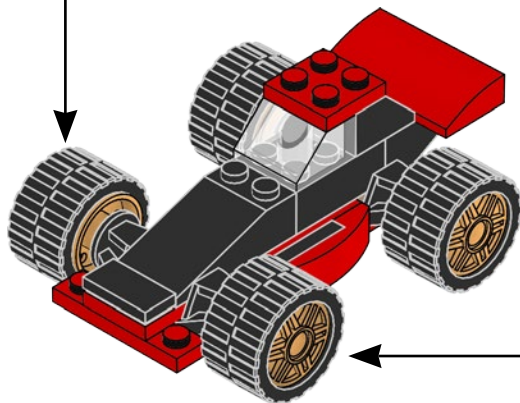

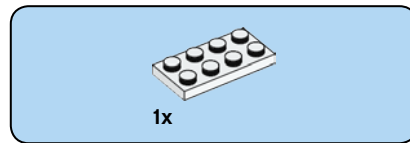
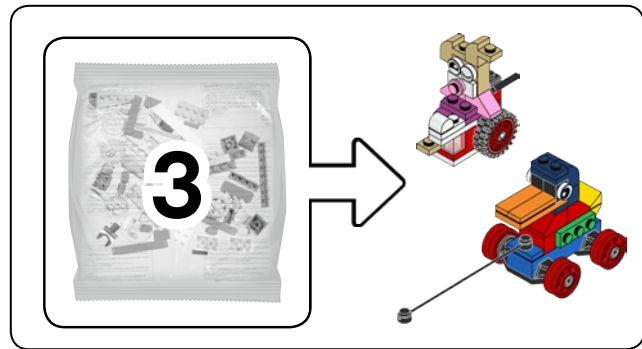

1

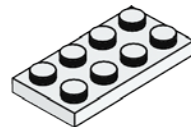

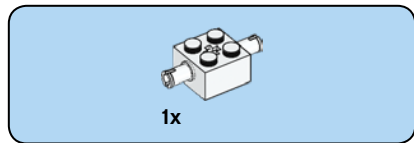

2

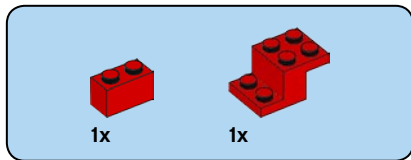
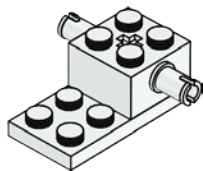

3

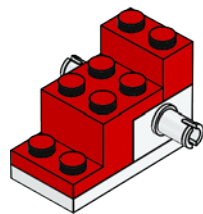



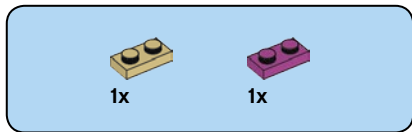

4

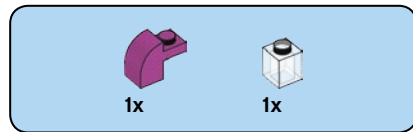
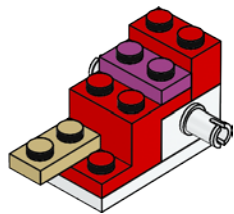

5

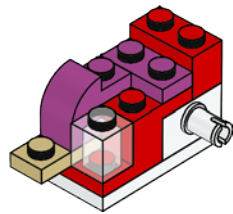



1x

6

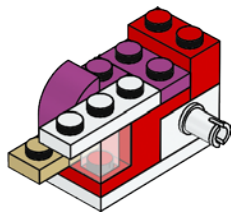

1x



1x

7

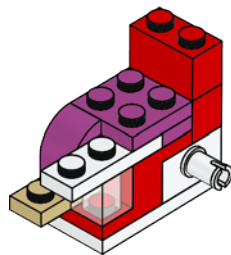



8

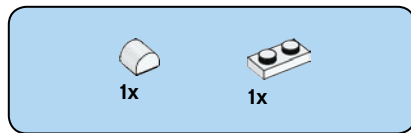
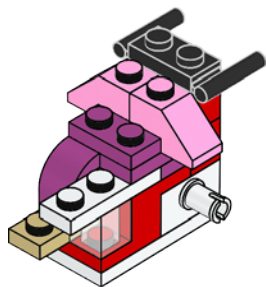

9

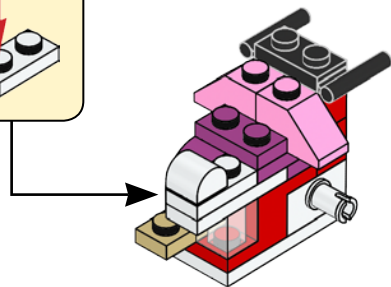
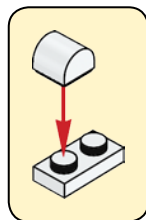

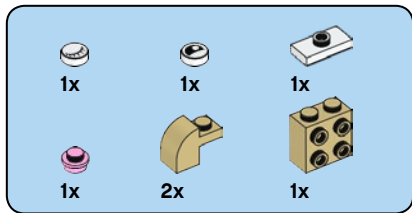

10

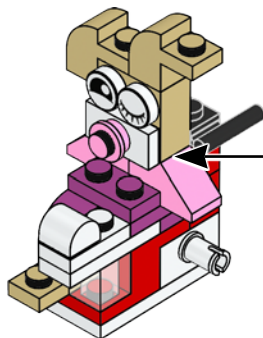
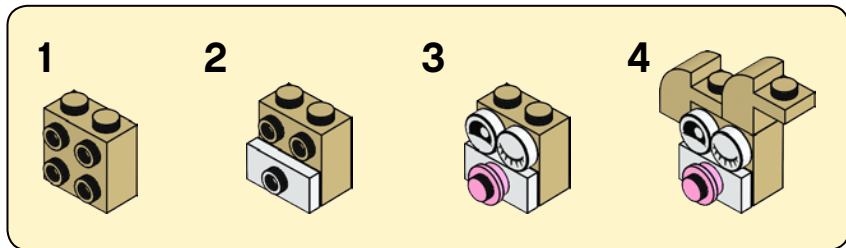

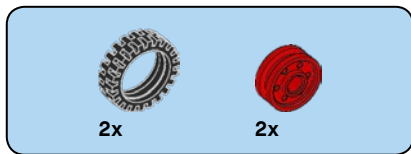

11

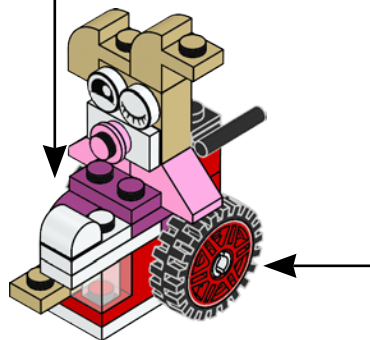
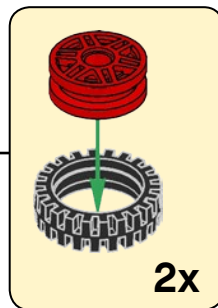

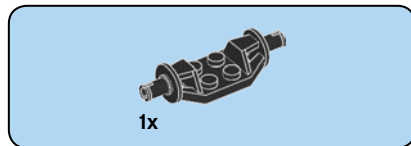

1



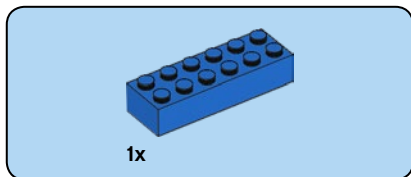

2

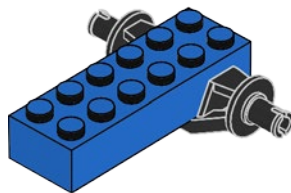



1x

3

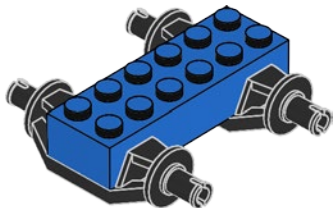



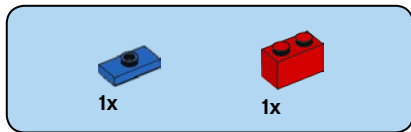

4

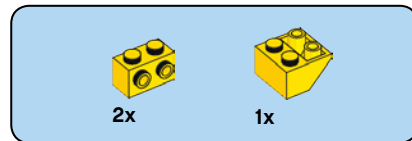
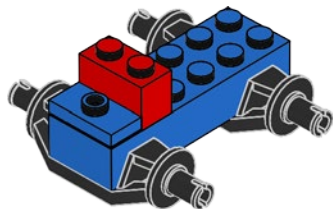

5

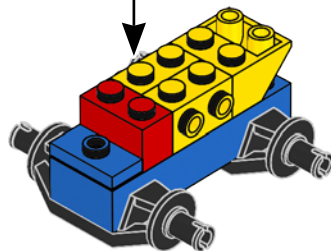
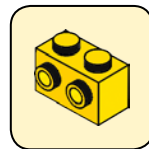



2x

6

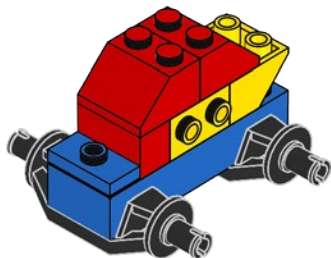

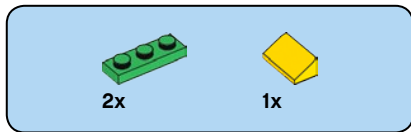

7

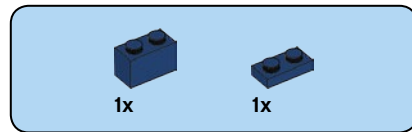
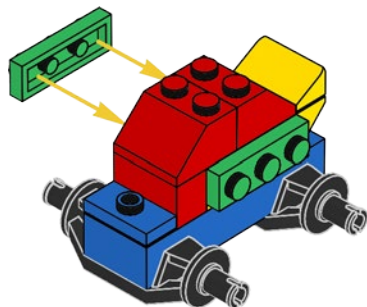

8

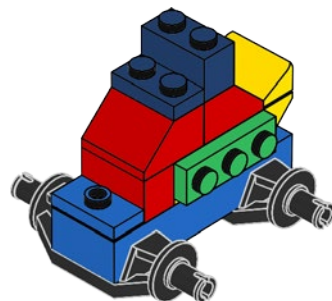

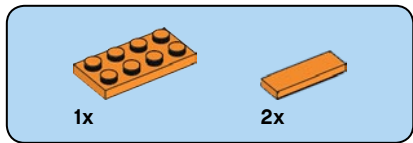

9

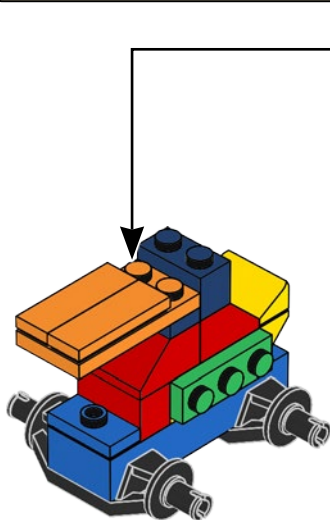
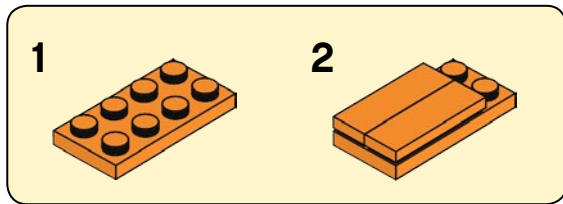



2x

10

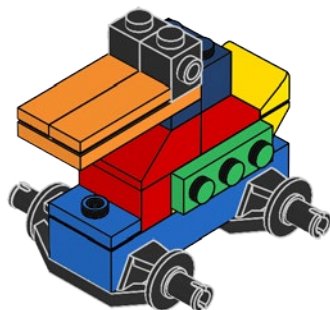



2x

11

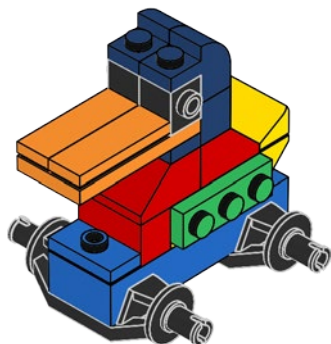

1x



2x

12

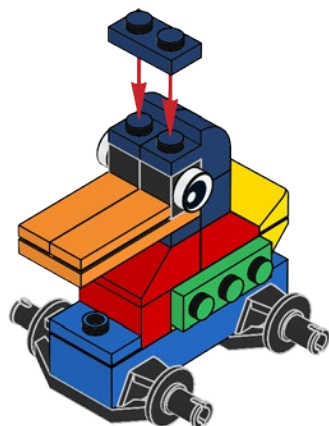

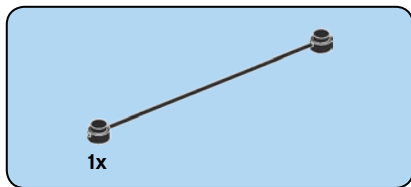

13

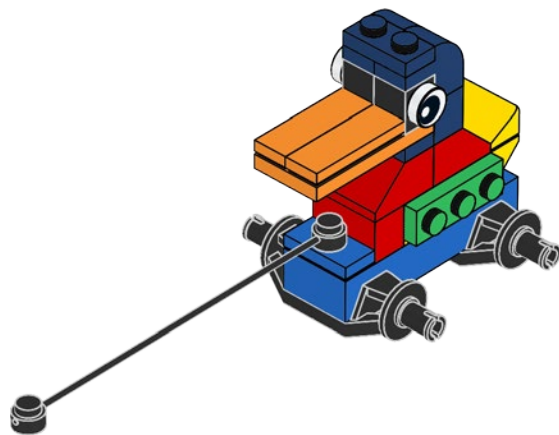



4x

14

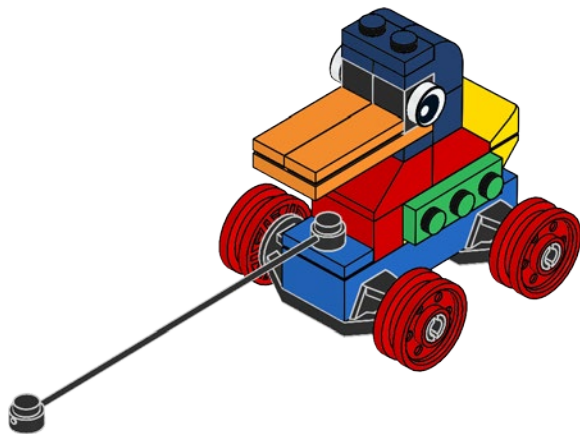





# CLASSIC



What fun things can you build?  
Quels objets amusants peux-tu construire ?  
¿Qué cosas divertidas puedes construir?





# CLASSIC



10696



10698



10713



11013



11010



10700



10714



10701



1x  
300226



1x  
374726



1x  
383926



2x  
4660876



2x  
302026



2x  
4600178



1x  
4185583



4x  
4217725

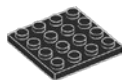

1x  
4243819

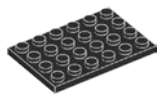

1x  
303226



1x  
303426

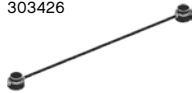

1x  
6096955



1x  
4529239



1x  
6129807



2x  
6117971



2x  
4556159



2x  
4565388



1x  
300328



2x  
4107758



2x  
4164037



2x  
621528



1x  
371028



2x  
4566179



2x  
302028



2x  
4106356

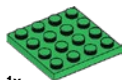

1x  
4243821

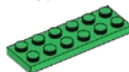

2x  
379528



2x  
4220634



2x  
4164037



2x  
4650630



2x  
4220632



1x  
4617069



1x  
4187743



1x  
4504850

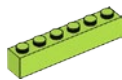

2x  
4537919



1x  
6274738



4x  
6240030



2x  
6245250



1x  
6220959



2x  
6244904



1x  
6239418



4x  
6244886



1x  
6253681



1x  
6240532



2x  
6208450



2x  
6245252



1x  
6244905



3x  
6240212



2x  
6244885



2x  
6240214



2x  
6245256



1x  
6244907



1x  
6244908



2x  
6167615



2x  
4620693



1x  
4158355

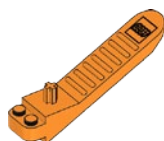

1x  
6240515



2x  
6249422



1x  
6244909

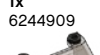

1x  
6247359



2x  
6254484



2x  
6022035



1x  
6109953



2x  
6103415



3x  
6109930



1x  
6022048



1x  
6035540



2x  
4541506



1x  
4177741



2x  
4504374



1x  
6253885



4x  
4249891



4x  
4528981



2x  
6115447



1x  
4296785



2x  
6025375



2x  
4530028



2x  
452089



2x  
6275133



1x  
6100239

**60**



2x  
6101285



2x  
4650244



2x  
4245571



1x  
6020923



2x  
4586057



2x  
6092035



2x  
4622062



2x  
6099730



1x  
6327855

2x  
6073042



2x  
6131583



2x  
6097503



1x  
6331205



3x  
6097511



3x  
6100027



2x  
6331526

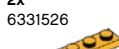

2x  
6020074

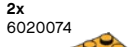

1x  
6097509

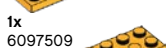

1x  
6133817



2x  
4211242



1x  
4221744



1x  
6035291



1x  
4660435



3x  
6223599



2x  
4223303



2x  
4629736



2x  
6335567



1x  
6092590



2x  
4211150



2x  
4211199



2x  
4211210



1x  
6251470



2x  
6338135



2x  
4270882



8x  
6194808



2x  
6335378



4x  
4621178



2x  
4278273

2x  
4211350



2x  
6015344



4x  
6044729



1x  
4211568



2x  
4211632



2x  
6276848



2x  
6265742



3x  
6273227



2x  
4211881



4x  
6109684

1x  
4221775



2x  
6267142



2x  
6063611



13x  
4211504



2x  
4211529



1x  
6093054



1x  
4211752



1x  
4211395



1x  
4243797



2x  
4211392



1x  
9566



1x  
4296152



1x  
6092582



2x  
6345427



2x  
4496366



































































2x  
301023



2x  
4181139



1x  
303223

						
1x 4114584	4x 300524	1x 4613151	2x 6004938	1x 6270008	1x 4109995	1x 6214334
						
2x 6029947	2x 4624985	2x 4597902	1x 6004943	2x 4211063	3x 4113917	1x 6171006
						
1x 4550348	2x 4188357	2x 301024	1x 6307482	2x 4211111	2x 6069165	4x 6285616
						
2x 614324	2x 6336971	3x 300124	2x 6154879	1x 4502068	2x 4273526	5x 6284605
						
1x 371024	2x 6079007		3x 4655172	4x 6256130	2x 4579260	4x 307001
						
1x 302224	2x 287724	1x 303224	2x 4619512	8x 6310372	1x 4624086	1x 625401
						
2x 302024	3x 366024	2x 4523159	2x 6136331	1x 4517996	1x 4666611	2x 614101
						
2x 4164073	2x 303924	2x 6284379	1x 4625027	2x 4517995	2x 6102999	8x 6011380
						1x 6258135
2x 6303233	3x 6119197	4x 6109685	2x 4211094	1x 6002148	1x 4114001	1x 6261349
						



2x  
6174937



4x  
366001



2x  
300301



2x  
362301



2x  
6186675



10x  
4578677



2x  
6122656



2x  
4535737



1x  
6089696



1x  
6035762



2x  
395701



3x  
302326



2x  
6184784



6x  
460026



2x  
393701



1x  
6284604



1x  
302101



2x  
302001



4x  
307026



2x  
4558954



1x  
6052126



1x  
6051511



6x  
6284599



2x  
6126046



2x  
4143000



1x  
306926



2x  
4548180



2x  
3003126



4x  
302301



2x  
306201



2x  
6126046



3x  
300101



1x  
303926



1x  
4107761



2x  
6093525



2x  
6285777



1x  
6313115



1x  
306801



3x  
300101



4x  
4246901



1x  
4140588



2x  
4565323



1x  
302201



7x  
300401



2x  
6146215



1x  
4181142



2x  
6168646



6x  
4516843



2x  
4541191



2x  
370001



4x  
4160228



1x  
4520970



1x  
303401



10x  
4295370



8x  
6132299



1x  
241226



3x  
4515368



2x  
366026



1x  
400626



8x  
4508215



10x  
4541455



5x  
4521439



2x  
300326



2x  
300426



1x  
4597912



1x  
371021



2x  
303721



2x  
300121



2x  
302021

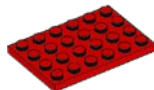

1x  
303221



2x  
303421



1x  
6132541



2x  
4278275



1x  
4521852



2x  
6168619



2x  
301021



1x  
6019155



1x  
6172642



2x  
4633914



1x  
74335



2x  
306221



1x  
9552



2x  
6072998



4x  
300521



2x  
6284574



1x  
6066342



1x  
302221



2x  
6275178



2x  
6117974



6x  
6048859



3x  
300421



2x  
303921



5x  
4612575



1x  
4226876



2x  
4600176



2x  
302321



1x  
4651524



2x  
6268946



Customer Service

Kundenservice

Service Consommateurs

Servicio Al Consumidor

LEGO.com/service or dial



+ 00800 5346 5555

+ 1-800-422-5346

# WIN

GO TO [WWW.LEGO.COM/PRODUCTFEEDBACK](http://WWW.LEGO.COM/PRODUCTFEEDBACK) AND  
GIVE US YOUR SHORT **FEEDBACK** ABOUT THIS  
LEGO® SET FOR A CHANCE TO WIN  
A COOL LEGO PRIZE.

Terms & Conditions apply



## LEGO.com/productfeedback

### GEWINNE

Erzähle uns auf  
[www.LEGO.com/productfeedback](http://www.LEGO.com/productfeedback)

etwas über die Erfahrungen, die du mit  
diesem LEGO® Set gemacht hast, und  
sichere dir die Chance auf einen coolen  
LEGO Preis!

Es gelten die Teilnahmebedingungen

### GAGNE

Rends-toi sur  
[www.LEGO.com/productfeedback](http://www.LEGO.com/productfeedback)

et donne-nous quelques commentaires sur  
ce produit LEGO® pour avoir une chance  
de gagner un prix LEGO !

Voir Conditions Générales

### GANAN

Visita  
[www.LEGO.com/productfeedback](http://www.LEGO.com/productfeedback)

y envíanos tu opinión acerca de este set  
LEGO®. ¡Participarás en el sorteo de un  
premio LEGO!

Términos y Condiciones aplicables

### 获取奖品

登录  
[www.LEGO.com/productfeedback](http://www.LEGO.com/productfeedback)

给出关于此乐高®套装的简短反馈，  
就有机会获得炫酷乐高奖品

《条款及条件》适用

LEGO and the LEGO logo are trademarks of the/son des marques de commerce de/son marcas registradas de LEGO Group. ©2021 The LEGO Group.

6349722