



duplo



10952

LEGO.com/DUPLO





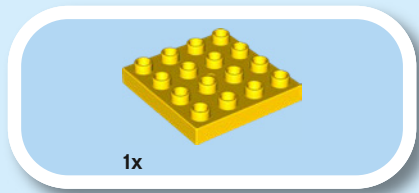

1

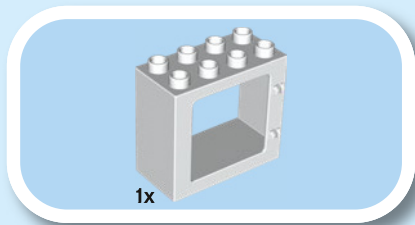
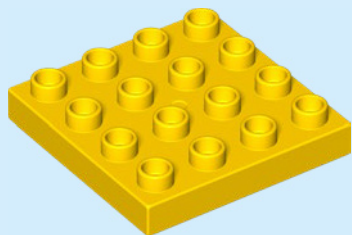

2



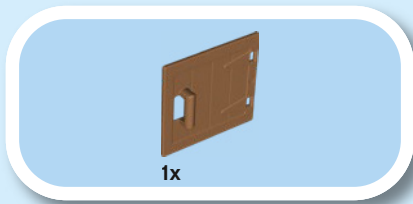

3

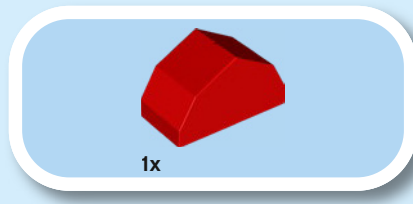
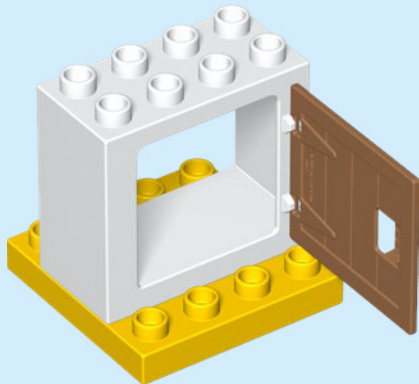

4



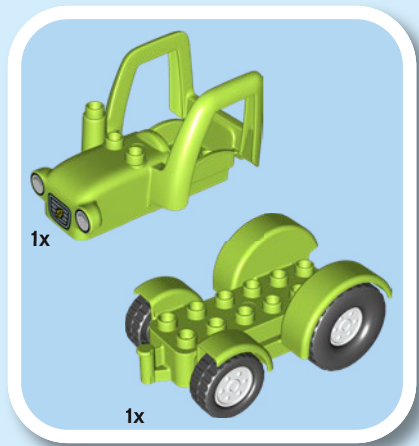

5

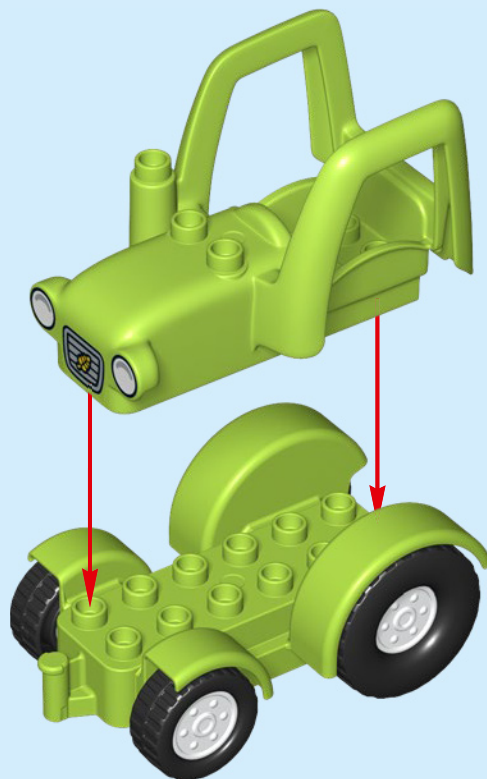



6







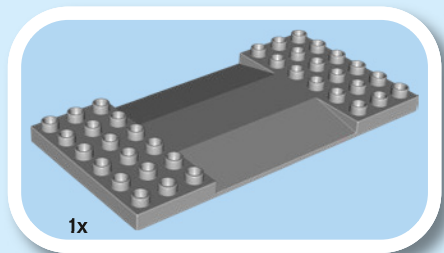

1

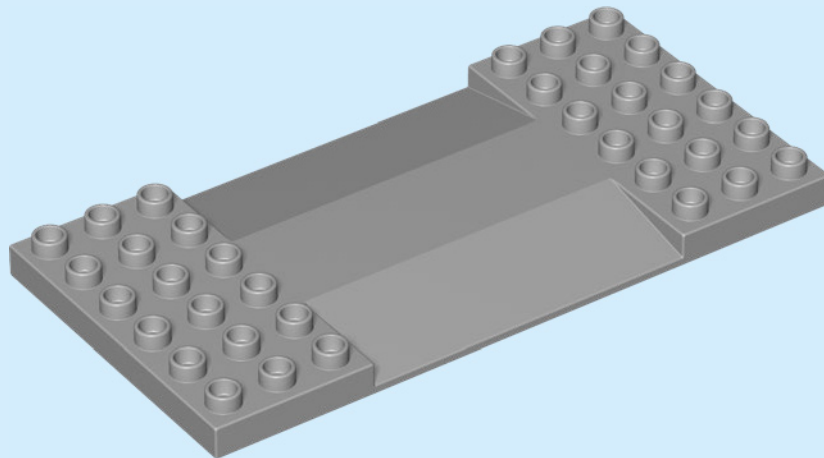

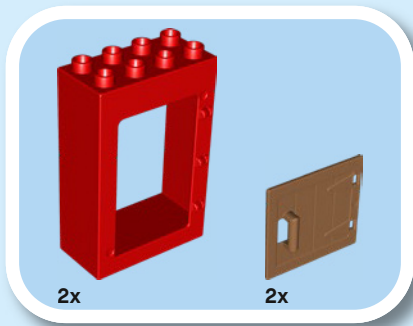

2

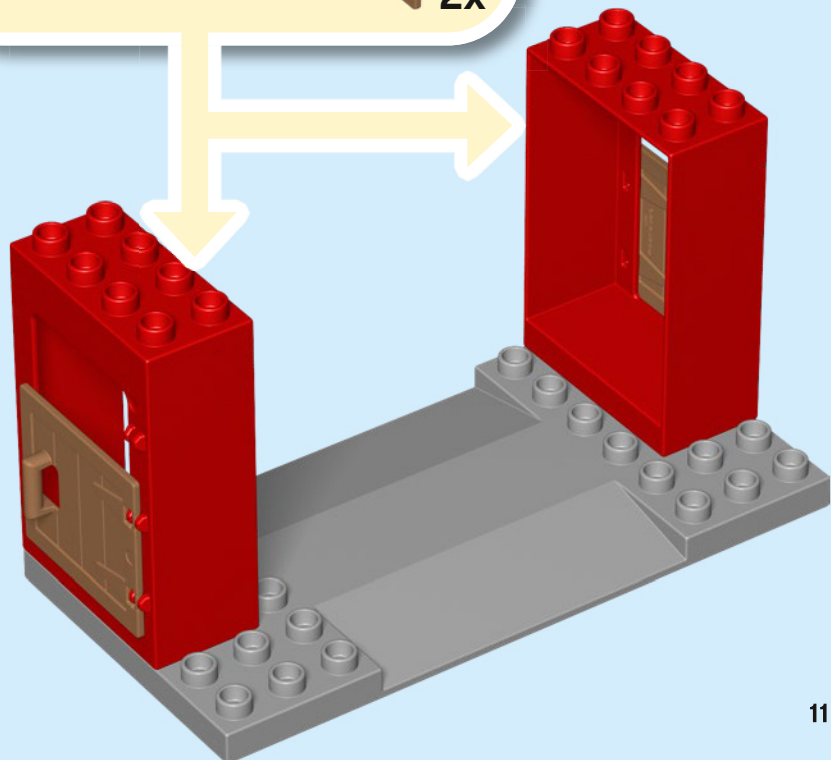
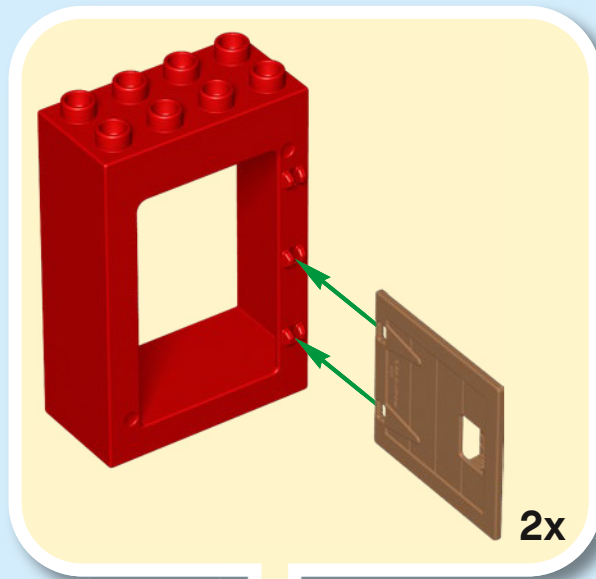



2x

3

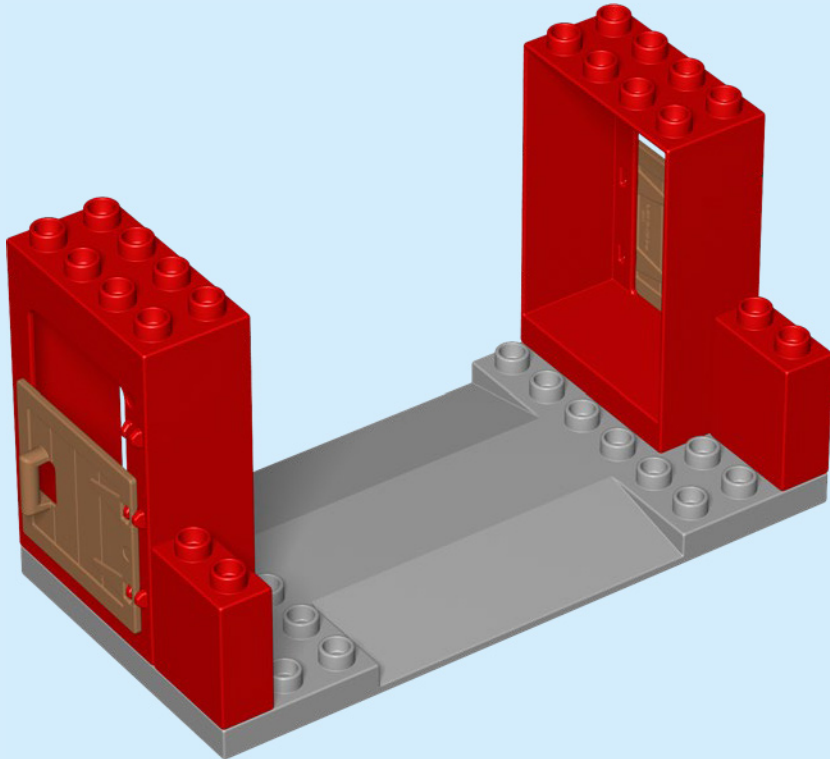

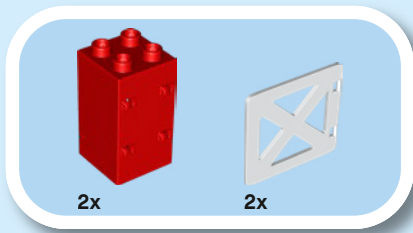

4

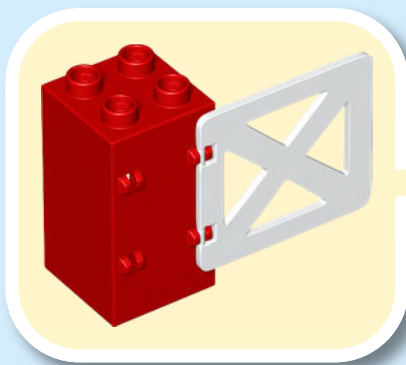
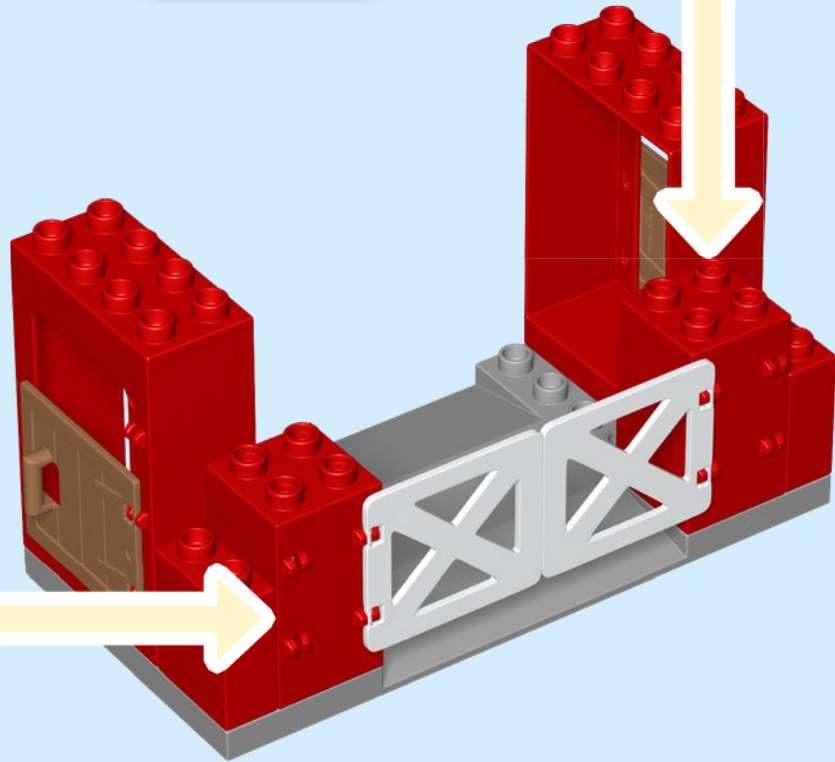
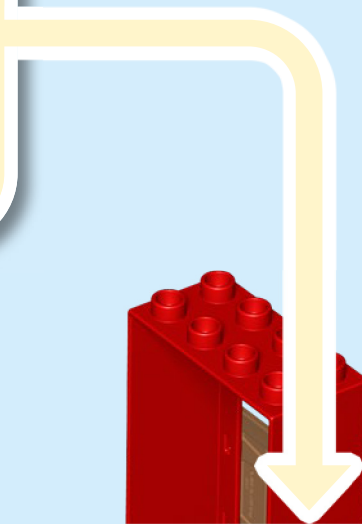
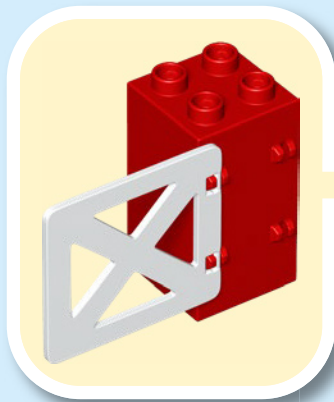

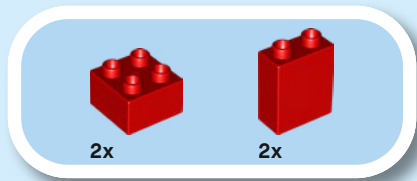

5

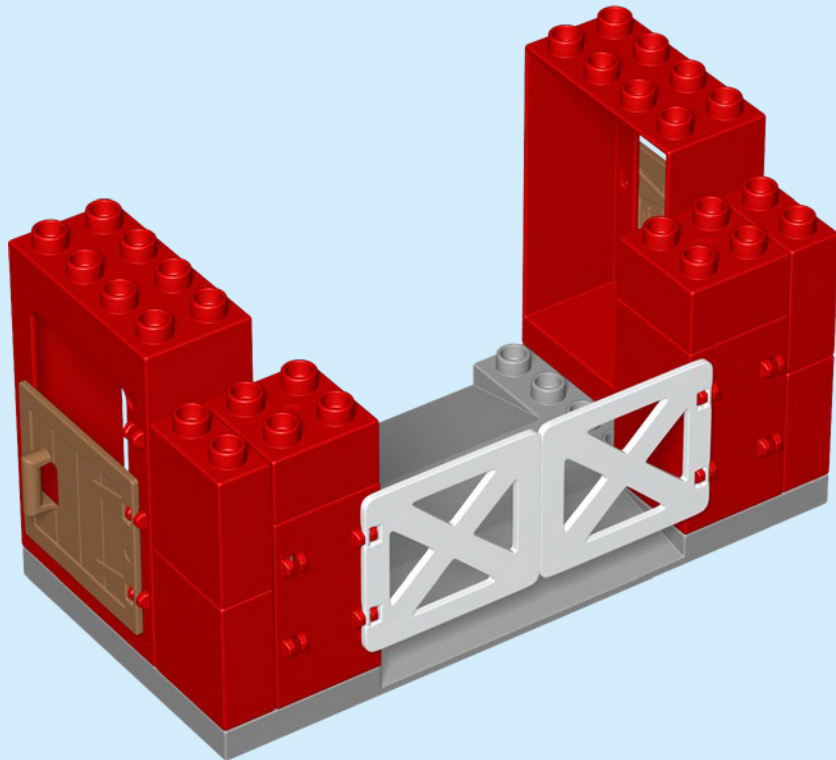

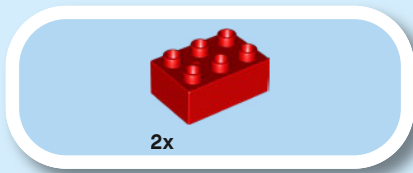

6

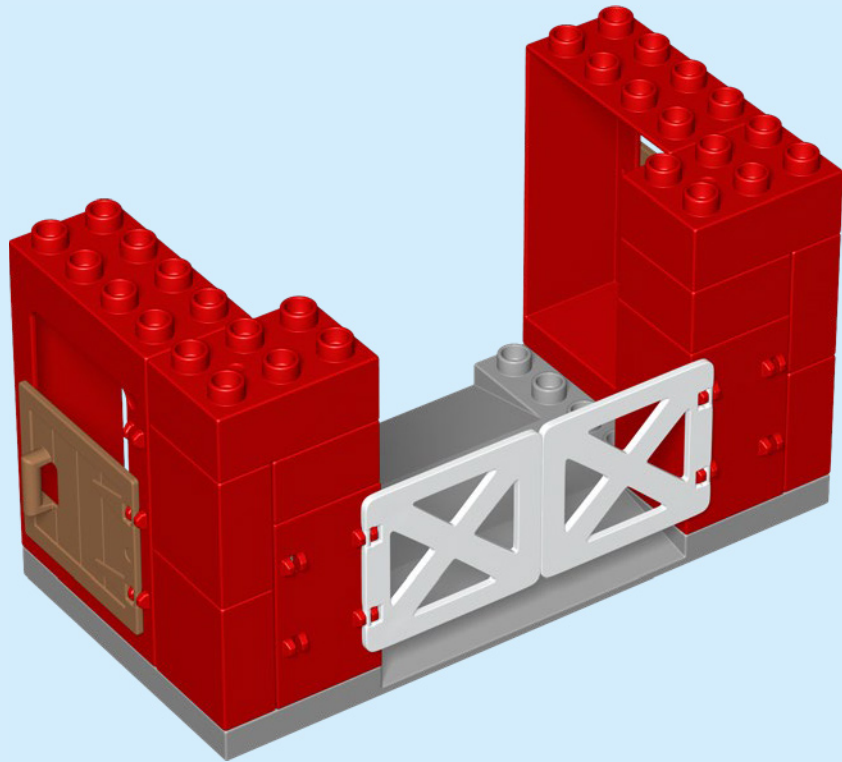

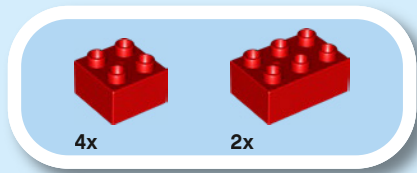

7

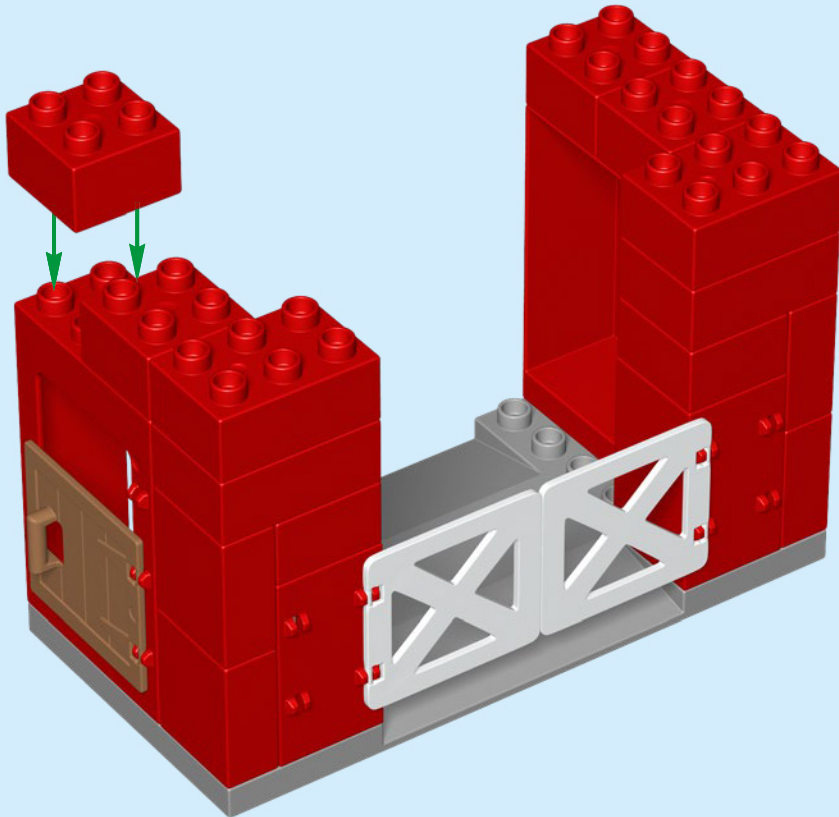

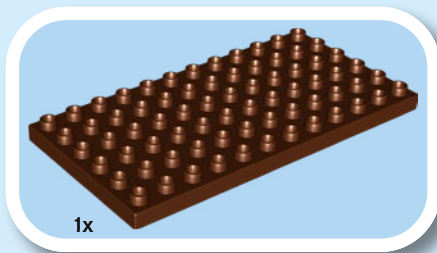

8

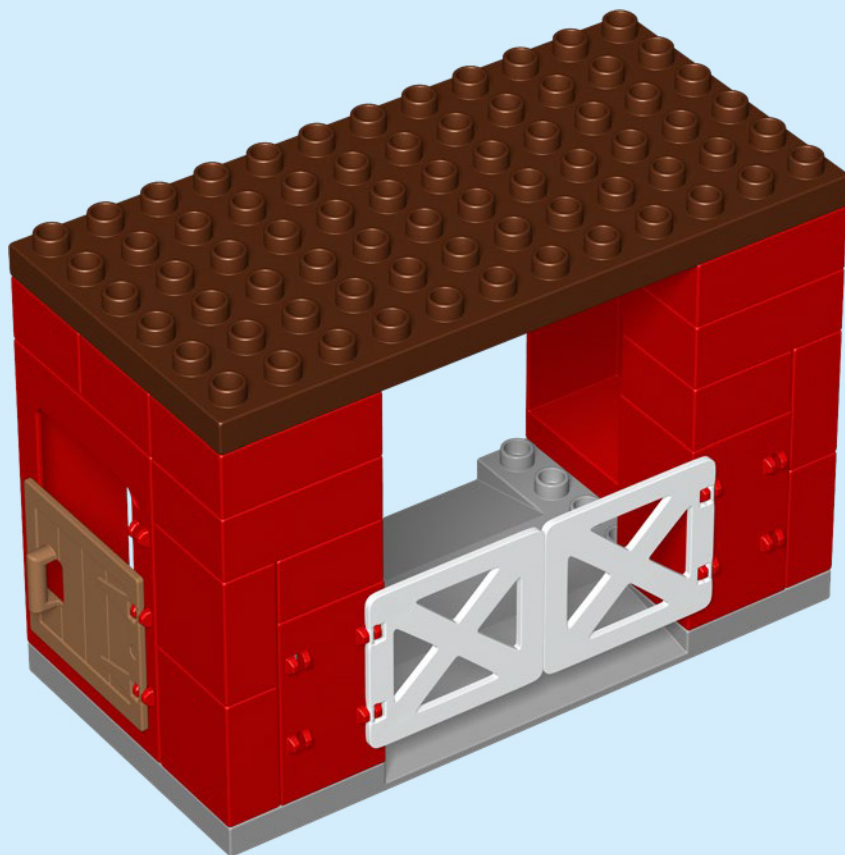

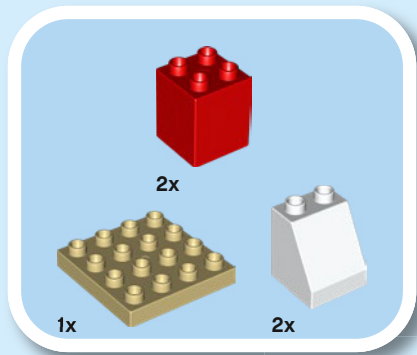

9

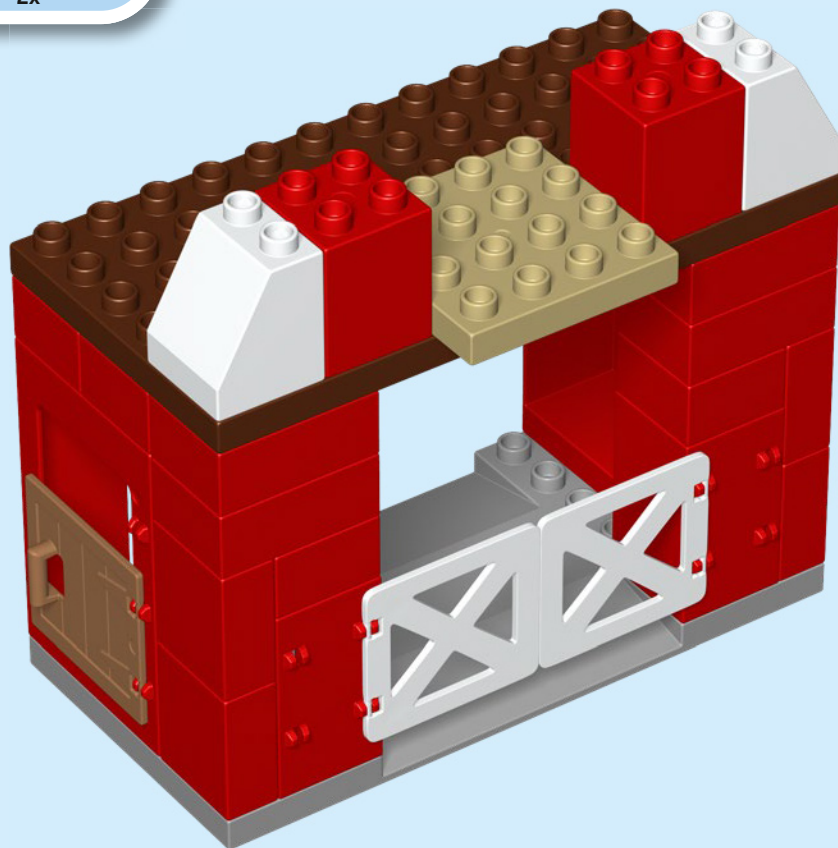

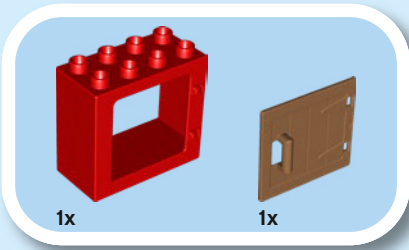

10

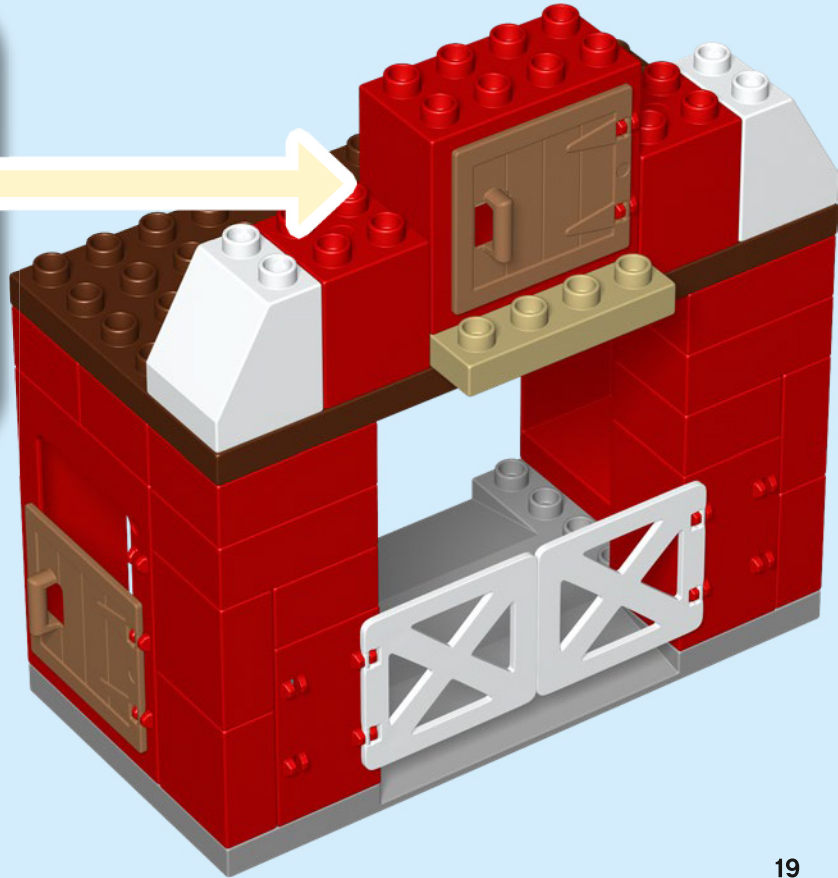
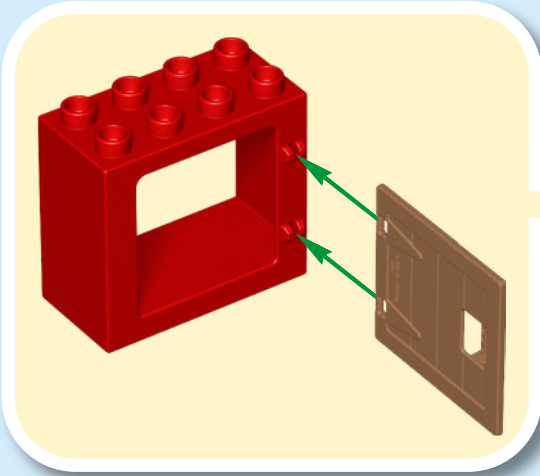

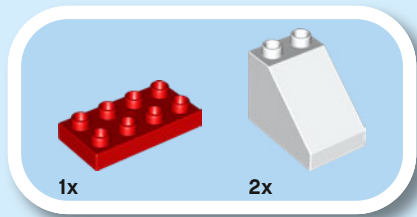

11

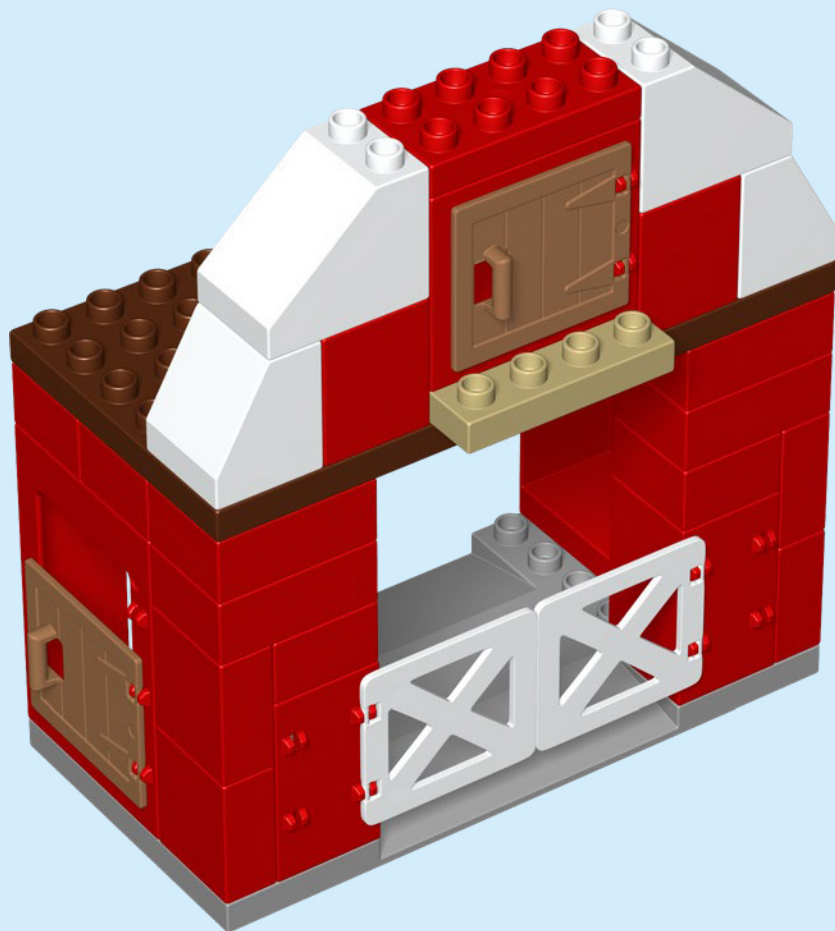

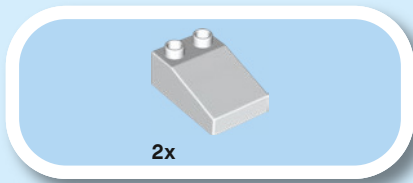

12

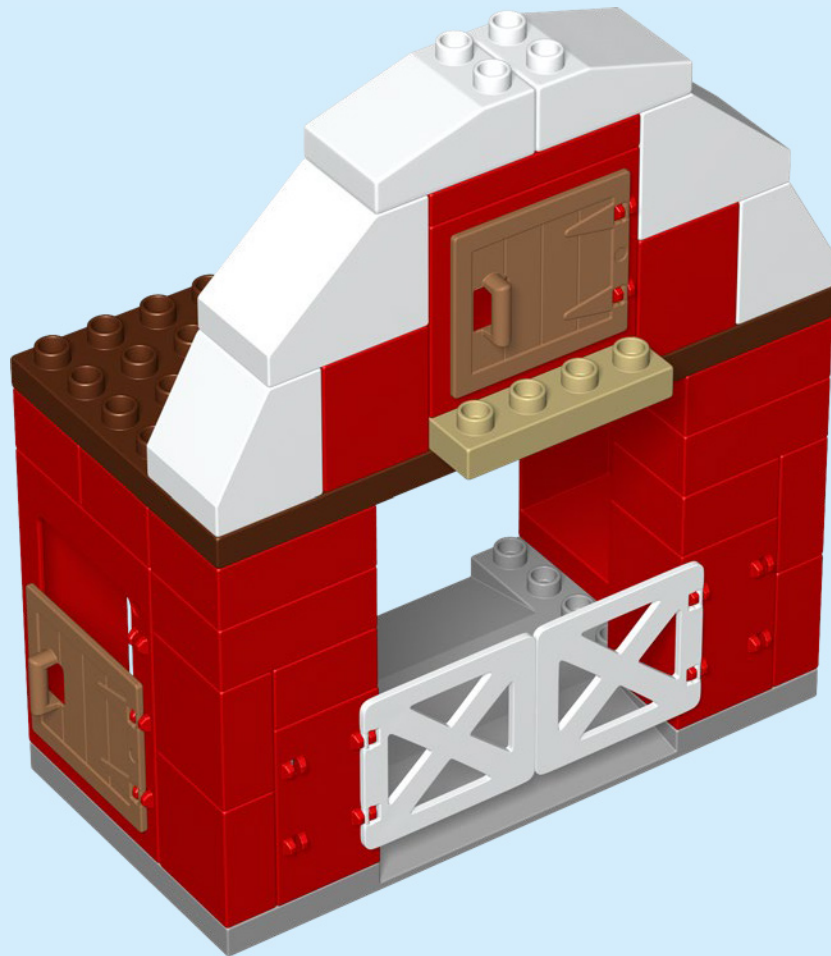

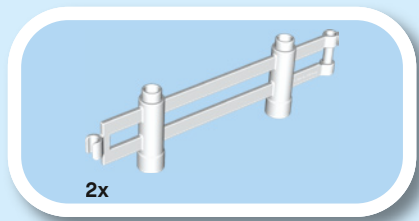

13

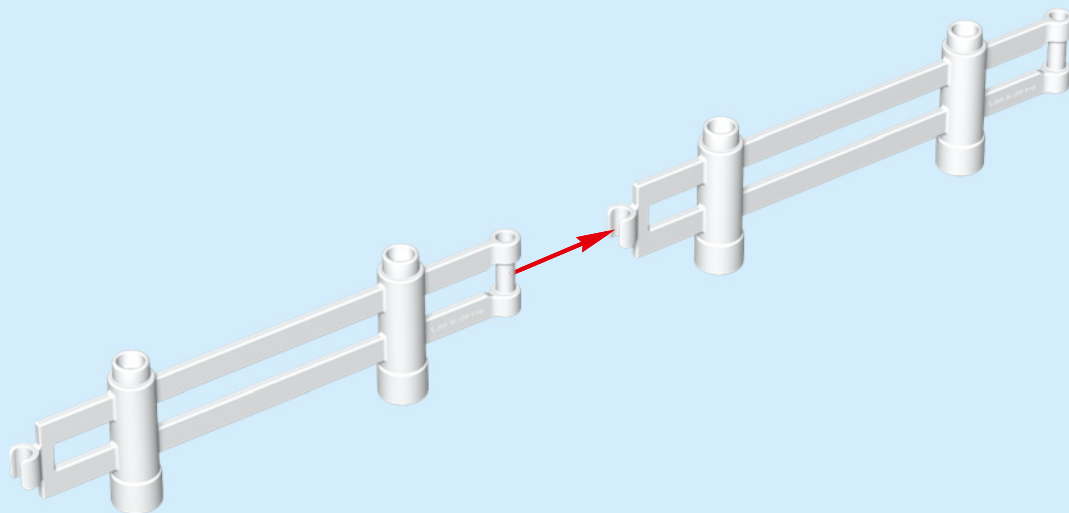



14

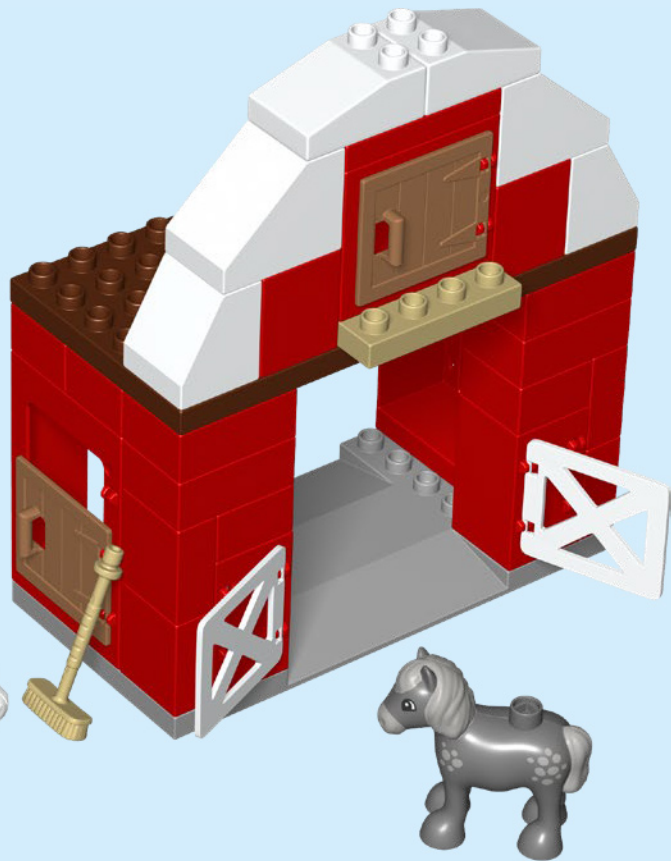
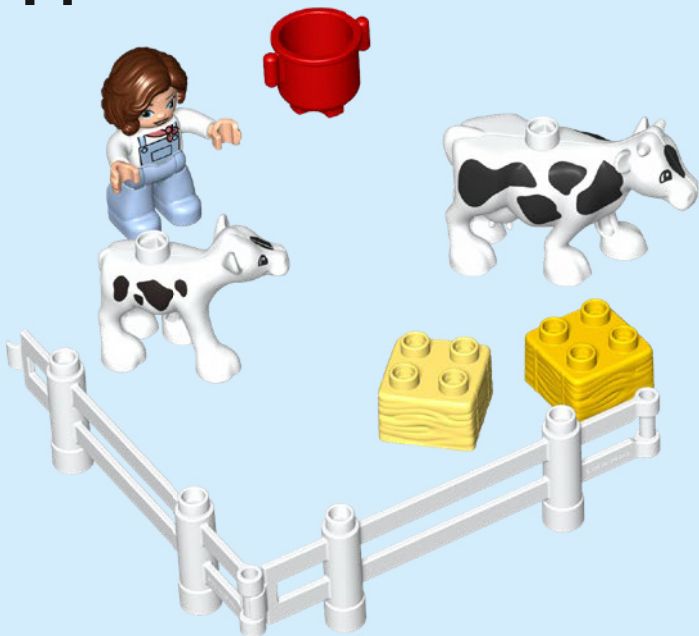

EXPLORE THE DIGITAL UNIVERSE UN UNIVERS NUMÉRIQUE À EXPLORER EXPLORA EL UNIVERSO DIGITAL



**COMPTINES
DUPLO[®]**

**CANCIONES
INFANTILES
DUPLO[®]**

LEGO, the LEGO logo, DUPLO and the DUPLO logo are trademarks of the/son des marques de commerce du/
son marcas registradas de LEGO Group.

©2021 The LEGO Group. All rights reserved/Tous droits réservés/Todos los derechos reservados. 6362461



Customer Service
Kundenservice
Service Consommateurs
Servicio Al Consumidor

LEGO.com/service or dial

 : 00800 5346 5555

 : 1-800-422-5346