

REAL RGB LED CPU COOLER WITH  
4D PATENTED CORRUGATED FIN DESIGN

# CNPS16X

## User's Manual

Ver. 010620

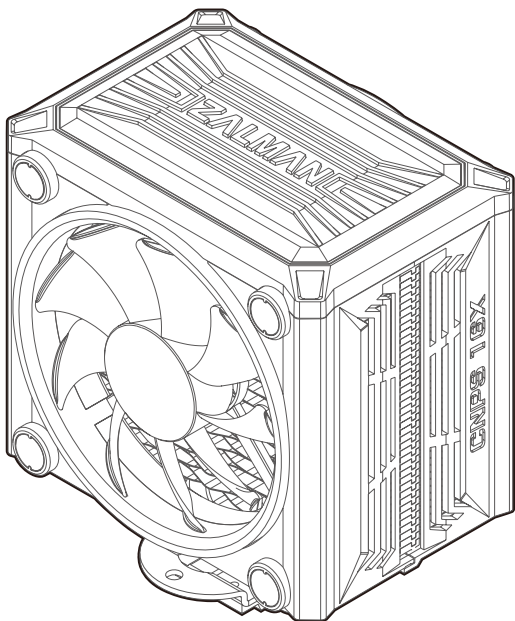

**Latest Intel & AMD Compatible**  
Intel Socket LGA2066/2011-V3/2011/115X CPUs  
AMD Socket AM4/AM3+/AM3 CPUs



Developed and designed by ZALMAN in Korea.  
This product is protected by ZALMAN's pending or registered patents.



[www.zalman.com](http://www.zalman.com)

\* To ensure safe and easy installation, please read the following precaution.

\* Product design and specifications may be revised to improve quality and performance without notice.

## Precautions

English

- Avoid tempering with objects or hands into the fan while it is in operation to prevent product damage and injuries.
- Do not eat the thermal grease, and avoid its contact with skin and eyes. If contact is made with skin, wash off with water. If irritation persists, seek medical attention.
- To prevent possible injuries, gloves must be worn while handling this product.
- Excessive force exerted on the fan may cause damage to the fan and/or system.
- Use and keep product away from reach of children.
- Check the components list and condition of the product before installation. If any problem is found, contact the retailer to obtain a replacement.
- Our company assumes no responsibility for any problem that occurs due to the use of the product for purposes other than its designated purposes and/or the carelessness of the consumer.
- Zalman Tech Co., Ltd. Is not responsible for any damages due to overclocking CPU such as, CPU and system components.
- During transportation of the system, the cooler must be removed. Zalman Tech Co., Ltd. is not responsible for any damages that occur during the transport of a system.
- Product design and specifications may be changed to improve quality and performance without notice.

## Précautions

Français

- Ne pas insérer d'objets ou les mains dans le ventilateur pendant son fonctionnement afin d'éviter des dommages au produit et des blessures.
- Ne pas ingérer la graisse thermique et éviter tout contact avec la peau et les yeux. Si elle entre en contact avec la peau, rincer avec de l'eau. Si l'irritation persiste, consulter un médecin.
- Pour éviter d'éventuelles blessures, il est obligatoire de porter des gants pour manipuler ce produit.
- Une force excessive exercée sur le ventilateur peut endommager le ventilateur et/ou le système.
- Veuillez utiliser et garder le produit hors de portée des enfants.
- Avant l'installation, vérifiez la liste des composants et l'état du produit. En cas de problème, contactez le détaillant afin d'obtenir un remplacement.
- Notre société n'assume aucune responsabilité pour tout problème se produisant en raison de l'utilisation du produit à des fins autres qu'objectifs désignés et/ou la négligence du consommateur.
- Zalman Tech Co., Ltd. n'est pas responsable des dommages éventuels résultant de l'overclocking du microprocesseur, tel que le microprocesseur et les composants du système.
- Au cours du transport du système, le refroidisseur doit être retiré. Zalman Tech Co., Ltd. n'est pas responsable de tout dommage qui pourrait survenir au cours du transport d'un système.
- La conception et les caractéristiques du produit peuvent être modifiées afin d'améliorer la qualité et la performance.

## Sicherheitshinweise

Deutsch

- Stecken Sie keine Gegenstände oder Ihre Hände in den Lüfter, während er in Betrieb ist, um Verletzungen oder eine Beschädigung des Produkts zu vermeiden.
- Verschlucken Sie die Wärmeleitpaste nicht und vermeiden Sie den Kontakt mit der Haut und den Augen. Bei Hautkontakt mit Wasser abwaschen. Falls Hautirritationen nicht abklingen, unbedingt einen Arzt aufsuchen.
- Tragen Sie bitte Handschuhe, um Verletzungen während der Montage zu verhindern.
- Die Ausübung von übermäßiger Kraft auf den Ventilator kann zu Schäden am Ventilator und/oder System führen.
- Verwenden und lagern Sie dieses Produkt außerhalb der Reichweite von Kindern.
- Überprüfen Sie vor der Montage die Liste der Komponenten und den Zustand des Produkts. Sollten Sie ein Problem finden, wenden Sie sich wegen Ersatz an den Händler.
- Unser Unternehmen übernimmt keine Verantwortung für Probleme, die aufgrund der Verwendung des Produkts für andere als die vorgesehenen Zwecke und/oder wegen Unachtsamkeit des Benutzers auftreten.
- Zalman Tech Co., Ltd ist für keine Schäden verantwortlich, die durch Übertaktung der CPU oder anderer Systemkomponenten entstanden sind.
- Während des Transports des Systems muss der Kühler ausgebaut sein. Zalman Tech Co., Ltd. ist nicht für Schäden verantwortlich, die beim Transport eines Systems entstehen.
- Das Produktdesign und die Spezifikationen können überarbeitet werden, um Qualität und Leistung zu verbessern.

## Precauciones

Español

- Evite atemperar con objetos o manos en el ventilador mientras esté en funcionamiento para evitar daños y lesiones al producto.
- No ingiera la grasa térmica, y evite su contacto con la piel y los ojos. Si se produce el contacto con piel, retire la grasa lavando la piel con agua. Si la irritación persiste, busque atención médica.
- Para prevenir posibles lesiones, deben llevarse puestos guantes mientras se manipula este producto.
- Un exceso de fuerza ejercida sobre el ventilador podría causar daños al ventilador y/o sistema.
- Utilice y mantenga el productor alejado de los niños.
- Compruebe la lista de componentes y la condición del productor antes de la instalación. Si encuentra algún problema, póngase en contacto con el distribuidor para obtener un reemplazo.
- Nuestra empresa no asume ninguna responsabilidad ante cualquier problema que se produzca debido al uso del producto para propósitos diferentes a los designados y/o la negligencia del consumidor.
- Zalman Tech Co., Ltd. no se responsabiliza de los daños que se produzcan en el «overclocking» de la CPU, como en la propia CPU como en los componentes del sistema.
- Durante el transporte del sistema, se debe retirar el refrigerador. Zalman Tech Co., Ltd. no es responsable de los daños que se produzcan durante el transporte de un sistema.
- El diseño y las especificaciones del producto podrían ser modificados para mejorar la calidad y el rendimiento.

## Меры предосторожности

Русский

- Во избежание поломки устройства и травмирования людей не помещайте посторонние предметы или руки внутрь вентилятора во время его работы.
- Не допускайте проглатывания термопасты и ее контакта с кожей и глазами. В случае попадания термопасты на кожу промойте пораженный участок водой. Если раздражение не проходит, обратитесь за медицинской помощью.
- Для предупреждения несчастных случаев и травм используйте перчатки при работе с данным изделием.
- Приложение чрезмерных усилий к вентилятору может привести к его повреждению и/или к повреждению всей системы.
- Используйте и храните этот продукт в местах, недоступных для детей.
- Перед установкой проверьте список компонентов и убедитесь в исправности устройства. В случае обнаружения каких-либо неисправностей обратитесь к дилеру, чтобы заменить устройство.
- Наша компания не несет ответственность за любые проблемы, возникшие при использовании и зделия не по назначению или по причине неосторожности потребителя.
- Компания Zalman Tech Co., Ltd. не несет ответственности за какой-либо ущерб вследствие превышения тактовой частоты ЦП и системных компонентов.
- Перед транспортировкой системы кулер необходимо снять. Компания Zalman Tech Co., Ltd. не несет ответственности за какой-либо ущерб, возникший во время транспортировки системы.
- Конструкция и технические характеристики изделия могут быть изменены с целью повышения качества и эксплуатационных характеристик устройства.

## 注意事項

日本語

- けがや製品の破損を避けるため、ファンの動作中は物や手を入れないようにしてください。
- 放熱グリスを口に入れしないでください。また、皮膚や目に触れないようにしてください。皮膚については、水で洗い流してください。炎症が続く場合は医療機関を受診してください。
- 怪我を防ぐため、本製品のお取り扱い中は手袋を着用してください。
- ファンに過度な力がかかると、ファンやシステムが損傷することがあります。
- 製品はお子様の手の届かないところで使用してください。
- 取付ける前に、構成部品一覧と製品の状態を確認してください。何らかの問題が見つかった場合は、小売業者に連絡して代替品を入手してください。
- 我々は他の目的で本製品を使用した際に起きた問題もしくは消費者の不注目で起きた問題に対しての責任は負いません。
- Zalman Tech Co., Ltd.は、CPUおよびシステム構成部品の損害を含む、CPUのオーバークロックに起因するいかなる損害についても責任を負いません。
- システムを輸送する際、クーラーを外してください。Zalman Tech Co., Ltd.は、システム輸送中の損害について責任を負いません。
- 品質と性能の向上のため、製品の設計および仕様が変更されることがあります。

## 预防措施

- 避免在风扇运行时将物体或手插入风扇，以防损坏产品和人员受伤。
- 请勿食用导热膏，同时避免其接触皮肤和眼睛。如果与皮肤产生接触，用清水洗净。如果仍感到刺痛，则应就医。
- 为防止可能发生的伤害，操作本产品时必须佩戴手套。
- 如果风扇受力过大，可能导致风扇和/或系统损坏。
- 使用及存放产品时，将其置于儿童接触不到的地方。
- 安装前，检查部件清单和产品状态。如若发现任何问题，请联系零售商更换。
- 我们公司对于因本产品用于不当用途和/或用户失误而造成的任何问题，不承担任何责任。
- Zalman Tech Co., Ltd. 对 CPU 及系统组件超频所致的任何损坏概不负责。
- 在系统运输过程中，必须拆下冷却器。Zalman Tech Co., Ltd. 对系统运输期间发生的任何损坏概不负责。
- 为了改进质量和提高性能，产品设计和规格可能有所变更。

## Precauções

- Evite introduzir objetos ou as mãos na ventoinha durante o seu funcionamento para evitar danos no produto ou lesões.
- Não ingira a massa térmica e evite o contacto com a pele e os olhos. Em caso de contacto com a pele, lave com água. Se a irritação persistir, procure assistência médica.
- Para evitar possíveis lesões, deve usar luvas ao manusear o produto.
- O excesso de força exercido sobre a ventoinha pode causar danos na ventoinha e/ou no sistema.
- Utilize e mantenha o produto fora do alcance das crianças.
- Verifique a lista de componentes e as condições do produto antes de proceder à instalação. Caso detete algum problema, contacte o revendedor para proceder à substituição.
- A nossa empresa não se responsabiliza por qualquer problema que ocorra devido à utilização do produto para finalidades que não as previstas e/ou na sequência de negligência por parte do consumidor.
- A Zalman Tech Co., Ltd. não se responsabiliza por quaisquer danos ao CPU, bem como aos componentes do sistema, causados por overlocking.
- Durante o transporte do sistema, o refrigerador deve ser removido. A Zalman Tech Co., Ltd. não se responsabiliza por quaisquer danos que ocorram durante o transporte de um sistema.
- O design e as especificações do produto podem ser modificados com vista a melhorar a qualidade e o desempenho.

## 주의사항

- 동작 중인 팬에 물체가 닿으면 팬이 손상되오니 주의하십시오.
- 동봉된 써멀 그리스를 먹거나 피부와 눈에 접촉되지 않도록 주의하십시오. 피부에 닿았을 때는 물로 씻으시고, 자극이 지속되거나 섭취한 경우 의사의 상담을 받으십시오.
- 본 제품 취급 도중 사고예방을 위해 반드시 장갑을 착용하십시오.
- 무리한 힘을 가할 경우 제품 및 시스템에 치명적인 손상이 발생될 수 있습니다.
- 어린이의 손이 닿지 않는 곳에서 보관/사용 하십시오.
- 설치 전 구성품 및 제품의 상태를 반드시 확인하고 이상이 있는 경우 구입처로 연락하여 교환 또는 환불 조치 받으십시오.
- 정해진 용도 외의 사용 및 소비자 부주의로 발생한 문제는 당사에서 책임지지 않습니다.
- 오버클럭킹으로 인한 CPU 및 시스템 손상은 당사에서 책임지지 않습니다.
- 컴퓨터 이동 시 외부충격이 가해질 수 있는 경우 반드시 컴퓨터에서 콜러를 제거한 후 컴퓨터를 이동해야 합니다. 컴퓨터 이동 중 발생된 CPU 및 시스템 손상은 당사에서 책임지지 않습니다.
- 제품의 외관 디자인 및 규격은 품질향상을 위하여 소비자에게 예고 없이 변경될 수 있습니다.

## Środki ostrożności

Polski

- Unikać wkładania przedmiotów lub rąk do wentylatora gdy pracuje, aby uniknąć uszkodzenia produktu lub obrażeń ciała.
- Nie spożywać smaru termicznego i unikać kontaktu smaru ze skórą i oczami. W przypadku kontaktu ze skórą, miejsce kontaktu należy przemyć wodą. W przypadku wystąpienia podrażnień należy uzyskać pomoc medyczną.
- Należy używać rękawic, aby zapobiec obrażeniom ciała w czasie instalacji.
- Wywieranie nadmiernej siły na wentylator może spowodować uszkodzenie wentylatora i/lub układu.
- Używać i przechowywać produkt z dala od dzieci.
- Przed montażem należy sprawdzić listę części oraz stan produktu. W przypadku wykrycia jakichkolwiek problemów należy skontaktować się ze sprzedawcą w celu wymiany produktu.
- Firma nie ponosi odpowiedzialności za wszelkie problemy wynikające z użycia produktu do celów innych niż jego przeznaczenie i/lub spowodowanych przez niedbałość użytkownika.
- Zalman Tech Co., Ltd. nie ponosi odpowiedzialności za wszelkie uszkodzenia części, jak. np. procesor CPU lub inne elementy systemu, powstałe wskutek przetaktowania procesora CPU.
- Podczas transportu systemu należy wymontować chłodnicę. Zalman Tech Co., Ltd. nie odpowiada za wszelkie szkody, jakie mogą wystąpić podczas transportu systemu.
- Konstrukcja produktu oraz dane techniczne mogą ulec zmianie w celu poprawy jakości i wydajności.

## Upozornění

Český

- Abyste zabránili poškození výrobku a zraněním, vyvarujte se vkládání rukou nebo předmětů do ventilátoru, když bude v provozu.
- Teplodivnou pastu nejezte a vyhněte se jejímu kontaktu s pokožkou a očima. Pokud dojde ke kontaktu s pokožkou, opláchněte dané místo vodou. Pokud přetrvá podráždění, vyhledejte lékařskou pomoc.
- Při manipulaci s produktem je třeba používat rukavice, aby se předešlo možným poraněním.
- Přílišná síla vyvíjená na ventilátor může způsobit poškození ventilátoru a/nebo systému.
- Používejte a udržujte produkt mimo dosah dětí.
- Před instalací zkontrolujte seznam komponent a stav produktu. Pokud zjistíte jakýkoli problém, kontaktujte prodejce se žádostí o výměnu.
- Naše společnost nepřijímá žádnou odpovědnost za jakýkoli problém, který nastane z důvodu použití produktu k jiným než určeným účelům a/nebo z důvodu nedbalosti spotřebitele.
- Společnost Zalman Tech Co., Ltd. není odpovědná za žádné škody způsobené přetaktováním CPU jako například CPU a systémových komponent.
- Během přepravy systému je třeba odstranit chladič. Společnost Zalman Tech Co., Ltd. nenes odpovědnost za žádné škody, k nimž dojde během přepravy systému.
- Provedení výrobku a specifikace se mohou změnit za účelem vylepšení kvality a výkonu.

## Övintézkedések

Magyar

- Avoid tempering with objects or hands into the fan while it is in operation to prevent product damage and injuries.
- Do not eat the thermal grease, and avoid its contact with skin and eyes. Ha a bõrre kerül, mossa le vízzel! If irritation persists, seek medical attention.
- A sérülések elkerülése érdekében a termék manipulálásakor kesztyűt kell viselni.
- A ventilátort éré túlzott erőhatások károsíthatják magát a ventilátort és/vagy a rendszert.
- A terméket használja és tartsa gyermekektől elzárta.
- Telepítés előtt ellenőrizze az alkatrészek listáját és a termék állapotát. Ha bármilyen problémát észlelne, cseréltesse ki a terméket a kereskedőjével!
- Cégünk nem vállal felelősséget a termék szakszerűtlen vagy nem megfelelő használatából eredő problémákért.
- Zalman Tech Co., Ltd. Is not responsible for any damages dne to overclocking CPU such as, CPU and system components.
- During transportation of the system, the cooler must be removed. Zalman Tech Co., Ltd. is not responsible for any damages that occur during the transport of a system.
- Product design and specifications may be changed to improve quality and performance.

## Tedbirler

Türk

- Ürünün hasar görmesini ve yaralanmaları önlemek için fan çalışırken içerisine ellerinizi veya başka cisimleri sokmaktan kaçının.
- Termal yağı yemeyin, cildiniz ve gözünüzle temasından kaçının. Cilde temas etmesi halinde bölgeyi suyla yıkayın. Tahriş devam ederse, tıbbi yardım alın.
- Olası yaralanmaları önlemek için ürünü kullanırken eldiven takılmalıdır.
- Fanın üzerine aşırı kuvvet uygulamak fana ve/veya sisteme zarar verebilir.
- Ürünü çocukların ulaşamayacağı yerlerde kullanın ve saklayın.
- Kurulumdan önce ürünün bileşen listesini ve durumunu kontrol edin. Herhangi bir sorun bulunması durumunda ürün değişikliği için satıcı ile iletişime geçin.
- Şirketimiz, ürünün, tasarlanan amaçları dışındaki amaçlar için kullanılması ve/veya tüketicinin özense zliği nedeniyle meydana gelen herhangi bir sorunun sorumluluğunu üstlenmez.
- Zalman Tech Co., Ltd., CPU ve sistem bileşenleri gibi CPU hız aşırmasından kaynaklanan hiçbir hasardan sorumlu değildir.
- Sistemi taşırken soğutucunun çıkarılması gereklidir. Zalman Tech Co., Ltd. sistem taşınırken oluşabilecek hiçbir hasardan sorumlu değildir.
- Kalite ve performansı artırmak için ürün tasarımı ve teknik özellikleri değiştirilebilir.

## Precauzioni

Italiano

- Evitare di manovrare con le mani o altri oggetti all'interno della ventola mentre è in funzione, poiché questo potrebbe causare danni e lesioni.
- Non ingerire il grasso termico ed evitare il contatto con la pelle e con gli occhi. In caso di contatto con la pelle, sciacquare con acqua. Se l'irritazione persiste, consultare un medico.
- Per prevenire possibili lesioni, è necessario indossare guanti durante la movimentazione del prodotto.
- Una forza eccessiva applicata sulla ventola potrebbe causare danni alla ventola e/o al sistema.
- Utilizzare e mantenere il prodotto fuori dalla portata dei bambini.
- Controllare l'elenco dei componenti e le condizioni del prodotto prima dell'installazione. In caso di problemi, rivolgersi al rivenditore per ottenere la sostituzione del prodotto.
- La nostra azienda non si assume alcuna responsabilità per eventuali problemi dovuti all'utilizzo del prodotto per scopi diversi da quelli per i quali è progettato e/o per negligenza del cliente.
- Zalman Tech Co., Ltd. non è responsabile di alcun danno a CPU overclockate e componenti della CPU e del sistema.
- Durante il trasporto del sistema, il raffreddatore deve essere rimosso. Zalman Tech Co., Ltd. non è responsabile per eventuali danni che dovessero verificarsi durante il trasporto di un sistema.
- Il progetto e le specifiche del prodotto potrebbero subire modifiche mirate al miglioramento della qualità e delle prestazioni.

## Specifications

Model	CNPS16X	
Materials	Pure Copper, Pure Aluminum, ABS	
Dimensions	140(L) x 100(W) x 165(H)mm	
Weight	880g	
Heat Dissipation Area	5,117cm <sup>2</sup>	
Fan(s)	Dimensions	120(L) x 120(W) x 26(H)mm
	Bearing Type	EBR Bearing
	Fan Speed	800~1,500 RPM $\pm$ 10%
	Max Noise Level	27.0 dB(A) $\pm$ 10%
	Max Airflow	49 CFM
	Max Air Pressure	1.21mmH <sub>2</sub> O
	Rated Voltage	12 V DC
Thermal Compound (ZM-STC8)	Life Span	50,000 hours
	Volume / Net Weight	1.5g
	Temperature Range	-40°C ~ +150°C (-40°F ~ +302°F)

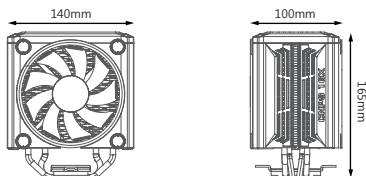

## Components



Cooler

Fan+Guide  
(Front)Fan+Guide  
(Reverse)Top LED  
Cover

Intel Guide



AMD Guide



Backplate



Washers



Side Caps



Nuts

Loading Block  
(Intel)Loading Block  
(AMD)Thermal  
Compound

Manual

Fixing  
BoltsStand-off  
NutsStandoffs(A)  
115X / AM3 / AM4Standoffs(B)  
2066 / 2011-V3 / 2011PWM Fan  
'Y' CableGigabyte  
CableLED  
Cable

## INTEL, AMD Backplate

## 1) Nuts Position

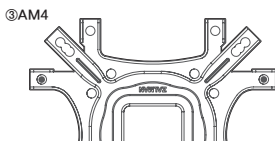
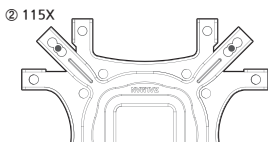
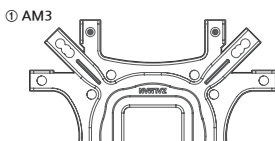
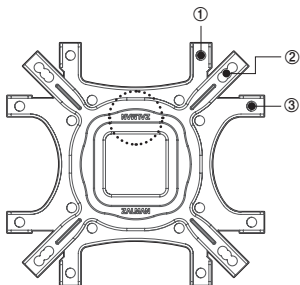
**Caution**

Please check the proper ZALMAN logo direction on backplate for each Intel and AMD socket.

No backplate is necessary for Intel LGA2066/2011-V/2011 socket.



## 2) 115X

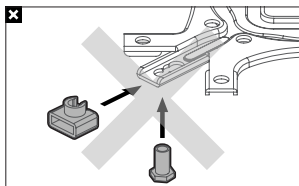
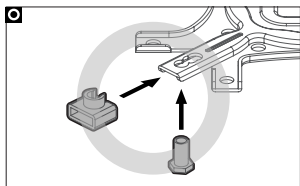
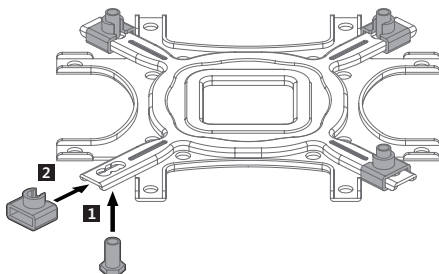



## 3) AM3

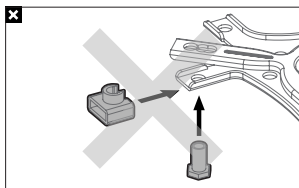
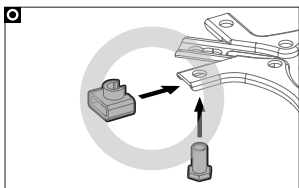
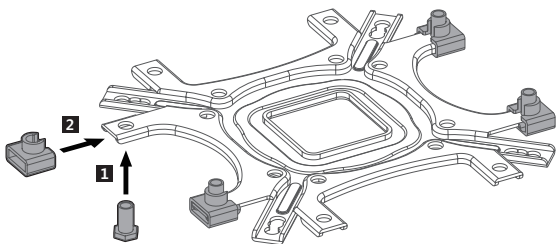

## 4) AM4

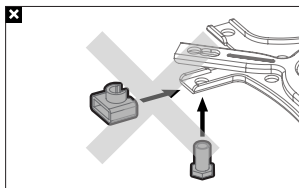
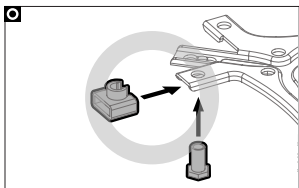
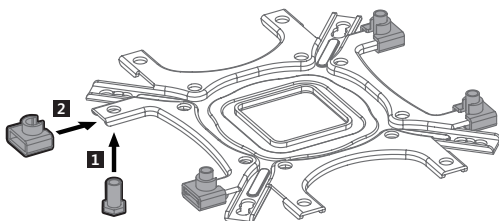
**Caution**

Take note of the orientation of the nuts and the side caps.

**INTEL, AMD Loading Block**

1) Intel

2) AMD

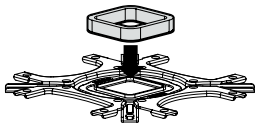
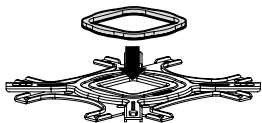
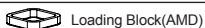
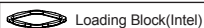

**Caution**

Remove the tape cover of loading block and attach it to the backplate.

**1. Intel Users**

1) LGA2066 / 2011-V3 / 2011

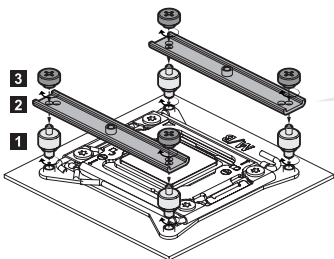
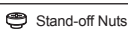

2) Nuts Position



**Caution**

Backplate is not needed for LGA2066 / 2011-V3 / 2011 sockets.

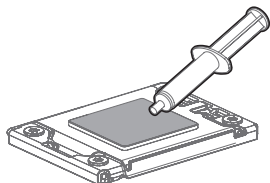
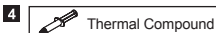

5

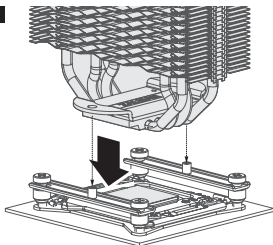

**Fixing Bolts**

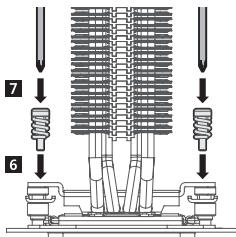

**Caution**

Screw-in both bolts in an alternating fashion until they are completely tightened.

**Detail Image**

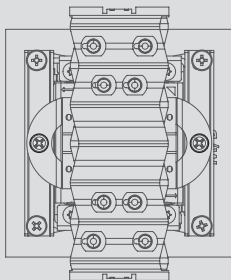

**8**



**Fan + Guide (Front)**

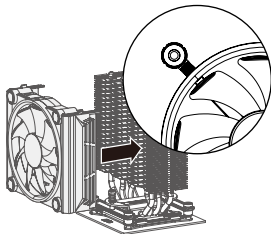

**9**



**Fan + Guide (Reverse)**

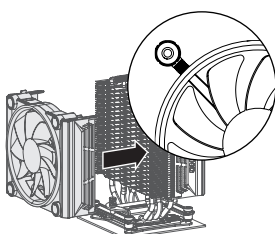

**Caution**

Please check the direction of the fan before installation.

**Cooler**

**Top LED Cover**

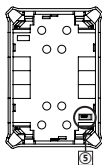
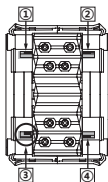

**10**

**Top LED Cover**

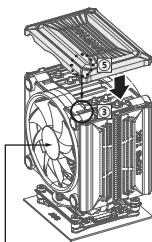

**11**

**Pin Connection**

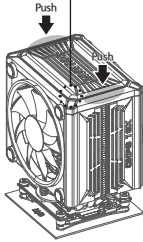

**Caution**

Be sure to connect ⑤ with ③.  
 ※ Placing ⑤ on ①, ② or ④ could cause malfunction & damage the product.

**Fan + Guide (Front)**

2) LGA115X

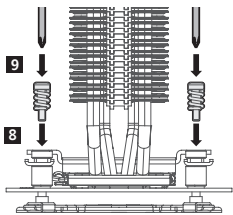
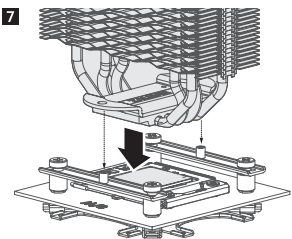
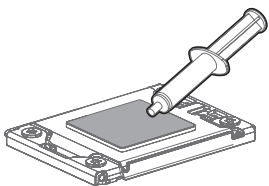
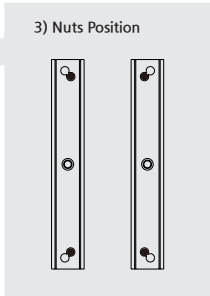
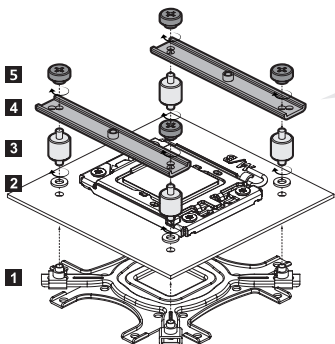
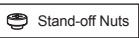
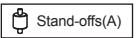

Detail Image

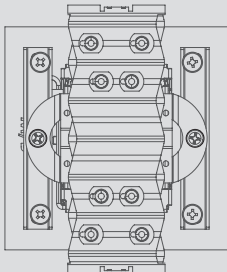

**Caution**  
 Screw-in both bolts in an alternating fashion until they are completely tightened.

10 Fan + Guide (Front)

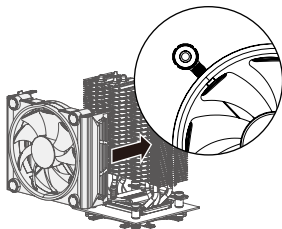

11 Fan + Guide (Reverse)

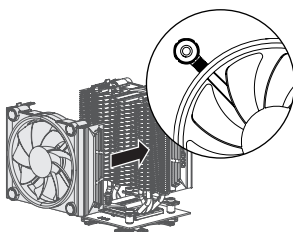

**Caution**

Please check the direction of the fan before installation.

Cooler

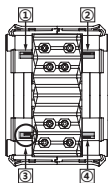

Top LED Cover

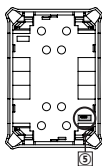

**Caution**

Be sure to connect ⑤ with ③.

※ Placing ⑤ on ①, ② or ④ could cause malfunction & damage the product.

12 Top LED Cover

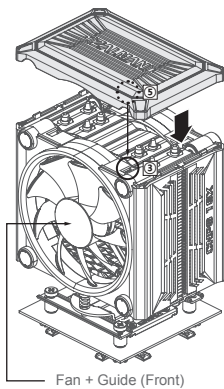

13

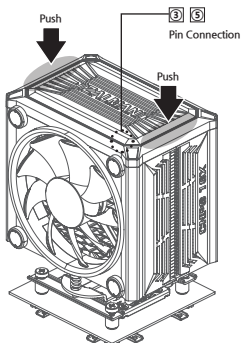

## 2. AMD Users

### 1) AM3 / AM4

Washers

Stand-offs(A)

AMD Guide

Stand-off Nuts

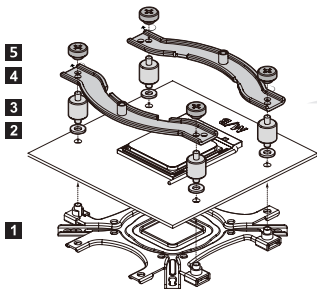

### 2) Nuts Position AM3

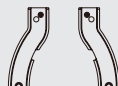

### AM4

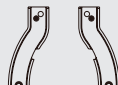

### Caution

Please be cautious for the direction of AMD Guide installation.

Thermal Compound

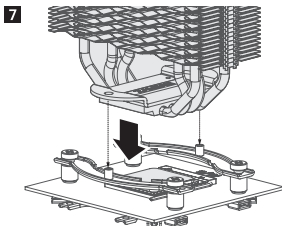
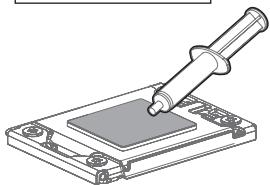

Fixing Bolts

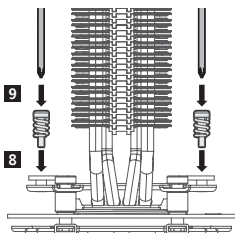

### Caution

Screw-in both bolts in an alternating fashion until they are completely tightened.

### Detail Image

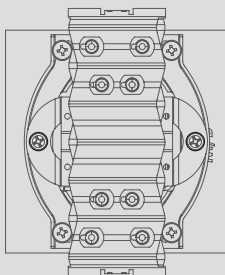

10



Fan + Guide (Front)

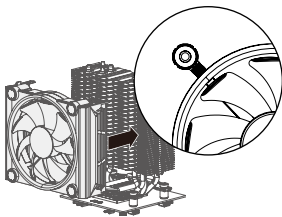

11

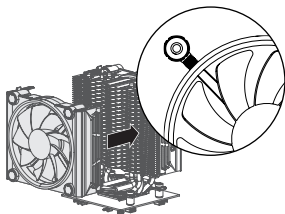

Fan + Guide (Reverse)

**Caution**

Please check the direction of the fan before installation.

Cooler

Top LED Cover

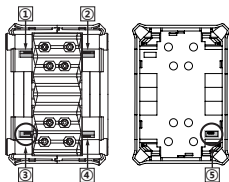
**Caution**

Be sure to connect ⑤ with ③.

※ Placing ⑤ on ①, ② or ④ could cause malfunction & damage the product.

12



Top LED Cover

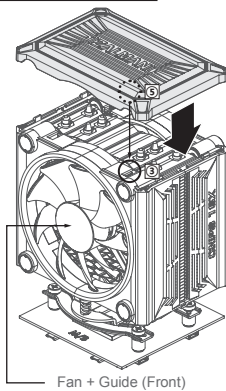

13

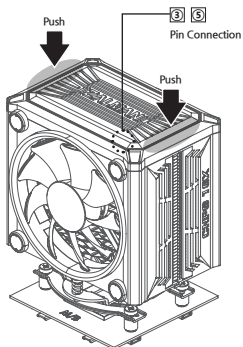

### 3. Installation Guide

#### 1) Top LED Cover (Install)

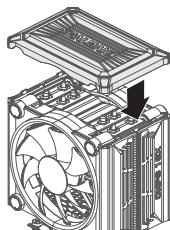

#### 2) Top LED Cover (Dismantle)

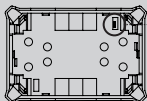
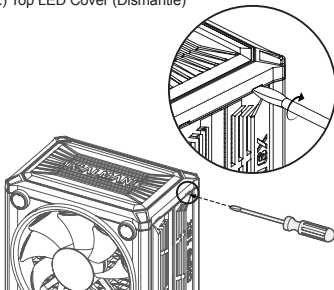

#### Caution

- Please be sure to check the RGB pins and its connector before installation.
- Please align RGB pins vertically to its connector during installation. (Pins can be bent if your alignment off).

#### 1) Fan + Guide (Install)

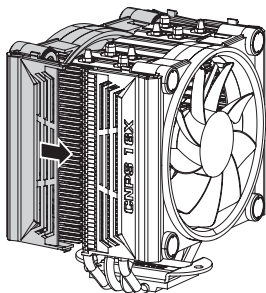

#### 2) Fan + Guide (Dismantle)

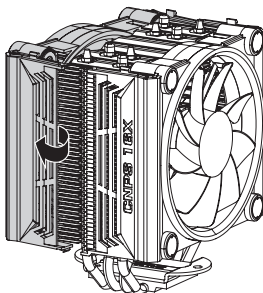

#### Caution

- Installation: align the fan guide on one side of the heatsink and lift the other side and slide it in.
- Dismantle: Lift the fan guide's side cover and pull it carefully.



## 4. Cable Connection

### 1) Connection to other motherboards

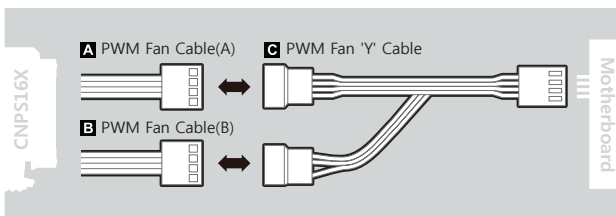
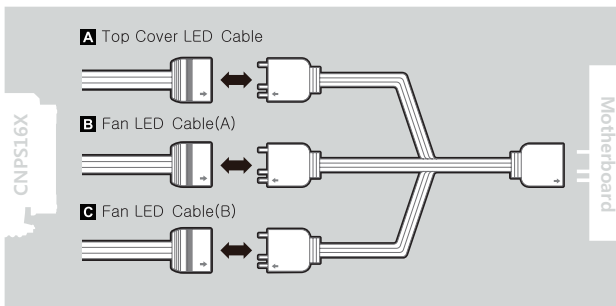

### 2) Connection to Gigabyte motherboards

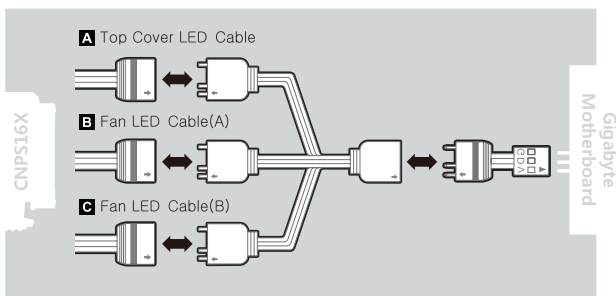



# 제품 보증서

제품명		모델명	
구입일	년 월 일	Serial No.	
구입처		판매 금액	

1. 품질 보증기간 : 제품 구입일로부터 1년. (단, 구입 영수증이 있을 때)
2. 무상 A/S : 품질 보증기간 내에 제품 자체 성능 상의하자 및 불량 발생 시.
3. 유상 A/S : 품질 보증기간 이후에 제품 사용상의 문제 발생 시.  
단, 아래와 같은 사항에 대해서는 품질 보증기간 이내라도 무상 A/S 처리가 되지 않으며, 소비자 부담으로 처리됩니다.
  - ① 본 사용 설명서에 명시된 설치 건 주의사항 및 유의사항을 지키지 않은 경우.
  - ② 사용자의 고의나 과실 및 부주의로 인하여 변형, 파손/파괴된 경우.
  - ③ 사용자의 임의 개조에 의한 변형 및 고장이 발생된 경우.
  - ④ 품질 보증 스티커가 제거 또는 훼손되었을 경우.
  - ⑤ 천재 지변으로 인해 고장이 발생된 경우.
  - ⑥ 비정상적으로 환경이 습한 곳, 먼지와 기타 이물질(벌레 등)이 많은 공간에서 사용되어 고장 난 경우.
4. 부품보유기간 : 제품 단종일로부터 2년 (단, 단종시점은 단종제품의 최종 출하일을 기준으로 합니다.)
5. A/S 안내
  - 1) 운영시간 : 평일 10:00 ~ 16:00 (공휴일, 토, 일요일 휴무)
  - 2) 접수방법
    - ① 방문 접수 : [www.zalmansvc.com](http://www.zalmansvc.com) 접속 및 회원가입 후 서비스 신청 접수 → 접수하신 제품 지참 후 방문
    - ② 택배 접수 : [www.zalmansvc.com](http://www.zalmansvc.com) 접속 및 회원가입 후 서비스 신청 접수 → 성명, 연락처, 증상 기재 후 택배 선불 발송
  - 3) 접수처
 

※ A/S센터의 정확한 위치 및 주소를 홈페이지에서 확인 후 방문 또는 택배발송.
6. 제품 운송비용
  - 1) 초기 불량인 경우 : 초기불량인 경우 왕복 운임비는 당사가 부담합니다.
  - 2) 무상 A/S의 경우 : 무상 기간 내의 택배 운임비는 1회(선불) 고객 부담을 원칙으로 합니다.
  - 3) 유상 A/S 및 보증기간 이후 : 왕복 비용 모두 고객 부담입니다.
7. 제조일자 확인방법

예제  2070118A01A00001 ①②	① 생산연도 표기 19년 → 19, 20년 → 20, 21년 → 21 ....
	② 생산연도 표기 1월 → 1, 2월 → 2, 3월 → 3 .... 10월 → A, 11월 → B, 12월 → C 표기

## Certification



This mark, designed by Zalman, indicates product compliance with the European Union's RoHS (Restriction of Hazardous Substances) Directive.



**Disposal of Old Electrical & Electronic Equipment**  
(Applicable in the European Union and other European countries with separate collection systems)

**ZALMAN**  
COOL INNOVATIONS

[www.zalman.com](http://www.zalman.com)