

20.20.1703.00

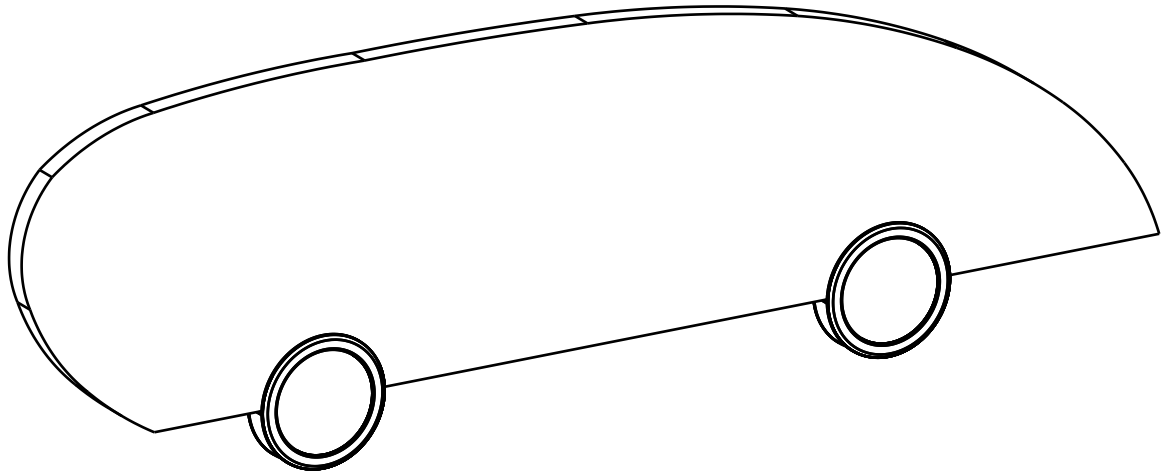

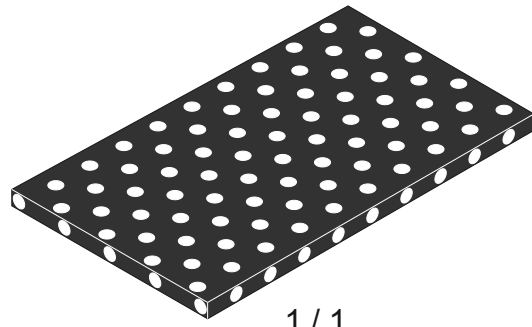
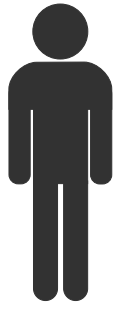

1 / 1

1 / 1

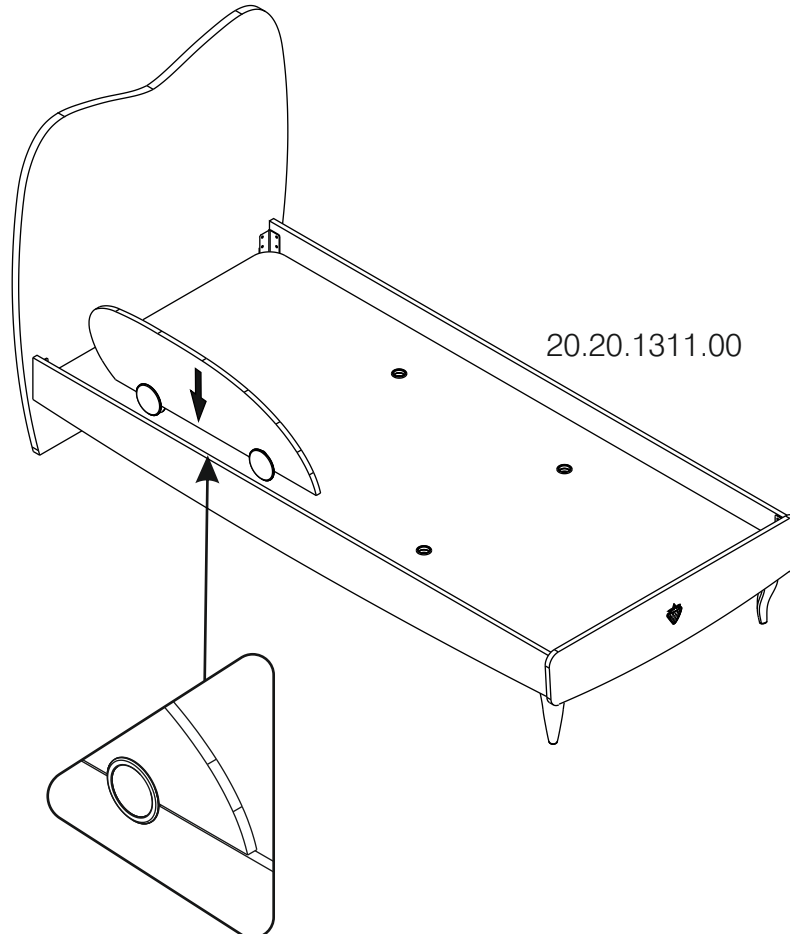
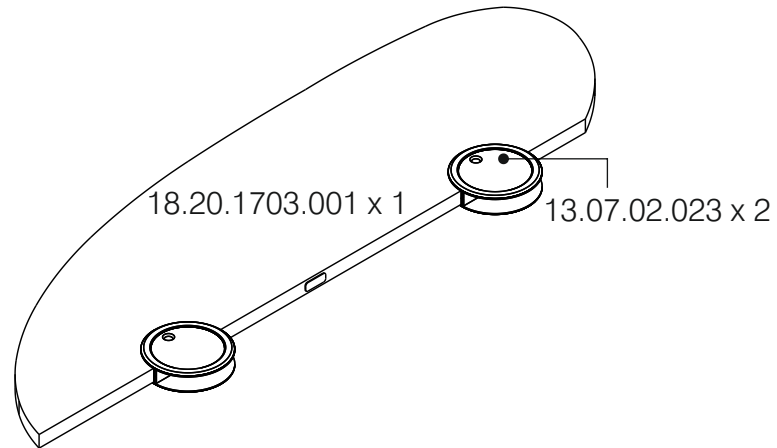

1