

**de** Montageanleitung  
 \*) über Kundendienst erhältlich  
**en** Installation instructions  
 \*) Available from customer service  
**fr** Notice de montage  
 \*) Disponible par le biais du service après-vente  
**it** Montaggio istruzioni  
 \*) Telex messaggio al de Servizioclienti verificabile  
**nl** Istruzioni per il montaggio  
 \*) Dostanete v službe zákazníkovi  
**pt** Instruções de montagem  
 \*) Se pode adquirir a nível do Serviço de Assistência Técnica Oficial da marca  
**ru** Инструкции по монтажу  
 \*) A vendição através dos nossos Serviços Técnicos  
**sk** Oδηγίες τοποθέτησης  
 \*) Získava na on-line stránke zákazníkovi  
**tr** Montaj klavuzu  
 \*) Yetkili servis üzerinden alınabilir  
**uk** Montersansvinstning  
 \*) Kan fas via Service

**de** Montersansvinstning  
 \*) fåes hos kundenservice  
**en** Montersansvinstning  
 \*) Kan kabes hos serviceafdelingen  
**fr** Assemblage  
 \*) Saatiavissa huoltopalvelusta  
**it** Montážní návod  
 \*) K dispozici přes servisní službu  
**nl** Návod na montáž  
 \*) Dostanete v službe zákazníkovi  
**pt** Instrução de montagem  
 \*) Do suporte técnico da marca  
**ru** Инструкция по монтажу  
 \*) Можно получить в сервисном центре  
**sk** Oδηγίες τοποθέτησης  
 \*) Získava na on-line stránke zákazníkovi  
**tr** Uygula za montáž  
 \*) Imoze dobiti kod službe održavanja  
**uk** Uputstvo za montáž  
 \*) Može se nabaviti preko servisne službe

**de** Navodilo za montažo  
 \*) Lahko nabavite v servisni službi  
**en** Navodilo za montažo  
 \*) Lahko nabavite preko službe za kupovani  
**fr** Udhëzues për montim  
 \*) Sigurohet nëpërmjet servitit  
**it** Monteeinstruhand  
 \*) Kijeste klientenservitit  
**nl** Montavmo instrukcija  
 \*) Ja galima gauti klientų aptarnavimo servise  
**pt** Montáže pamětk  
 \*) Var sagetni servisu dlema  
**ru** Инструкция по монтажу  
 \*) Можно получить через сервисную службу  
**sk** Oδηγίες τοποθέτησης  
 \*) Získava na on-line stránke zákazníkovi  
**tr** Montaj klavuzu  
 \*) Yetkili servis üzerinden alınabilir  
**uk** Оупуство за монтажу  
 \*) Може се набавити преко сервисне службе

**de** Ornatish yo'riqnomasi  
 \*) mijozlarga xizmat ko'rsatish markazida mavjud  
**en** Ornatish yo'riqnomasi  
 \*) Kiyeste klientenservitit  
**fr** Rykovođstvo za montaj  
 \*) predstava se ot službe za obslužavane na kliente  
**it** Montaggio istruzioni  
 \*) Telex messaggio al de Servizioclienti verificabile  
**nl** Istruzioni per il montaggio  
 \*) Dostanete v službe zákazníkovi  
**pt** Instruções de montagem  
 \*) Se pode adquirir a nível do Serviço de Assistência Técnica Oficial da marca  
**ru** Инструкция по монтажу  
 \*) Можно получить в сервисном центре  
**sk** Oδηγίες τοποθέτησης  
 \*) Získava na on-line stránke zákazníkovi  
**tr** Montaj klavuzu  
 \*) Yetkili servis üzerinden alınabilir  
**uk** Упупство за монтажу  
 \*) Може се набавити преко сервисне службе

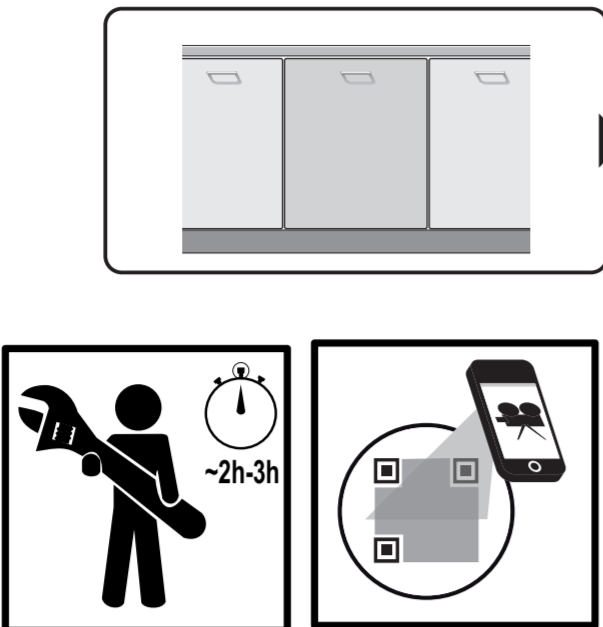

**1**

**3**

**5**

**4**



**2a**

**2b**



**3**

nicht einklemmen  
do not pinch  
ne pas coincer  
No doblar

**4**

verspannen  
brace  
calar verticalment  
Enrasar

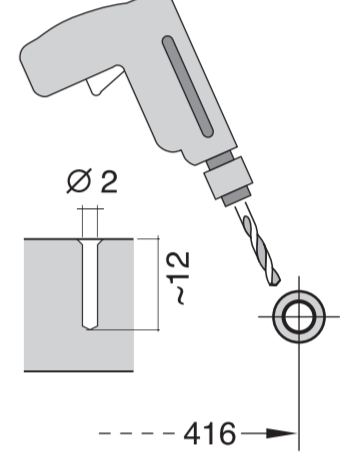

**5**

**6**



**6**

**7**



**8**

**GB**

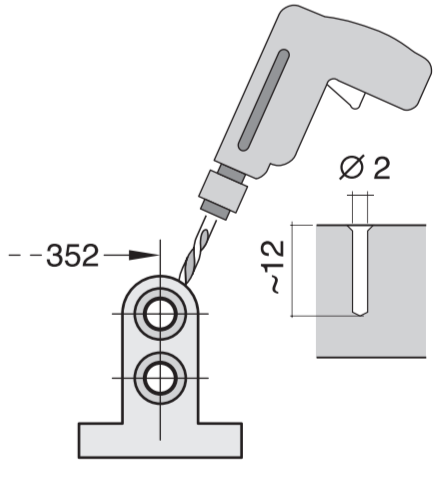
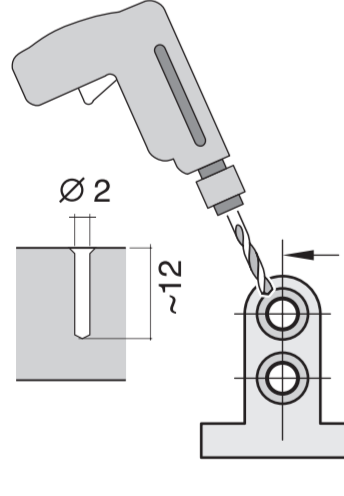

**9**

Scheibe entfernen  
remove disc  
enlever le disque  
Eliminar Disco

max. 10 Nm

Dichtheit nach einem Spülgang prüfen.  
Check for leaks after one wash cycle.  
Vérifiez l'étanchéité après un lavage.  
Verificar la estanquidad tras un ciclo de lavado.

**9**



**Mat.-Nr. 350564**

**EU** \*) Mat.-Nr. 644533  
**GB** \*) Mat.-Nr. 644534

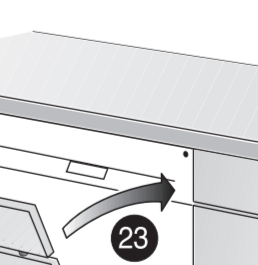
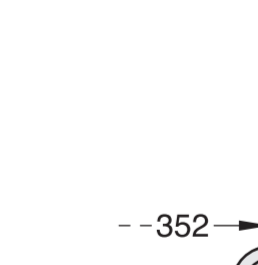
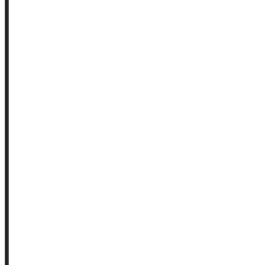
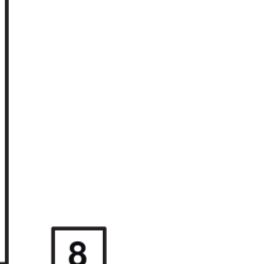
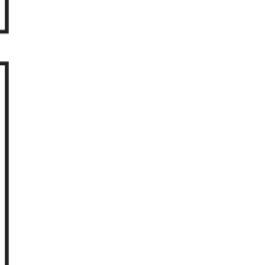
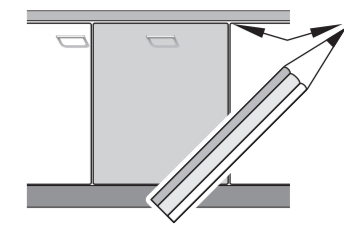
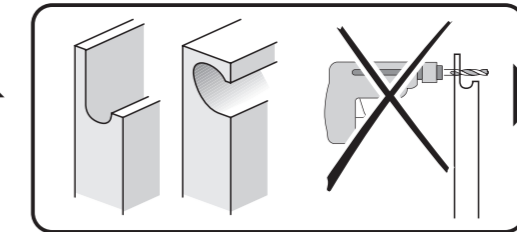
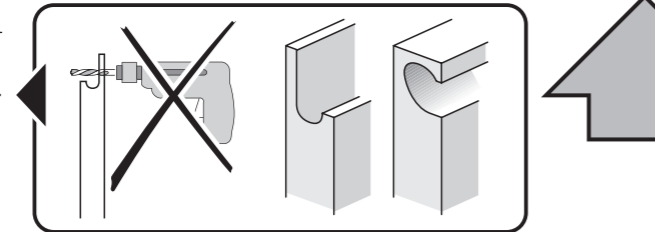
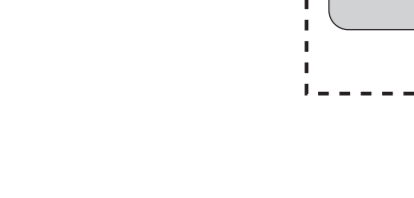
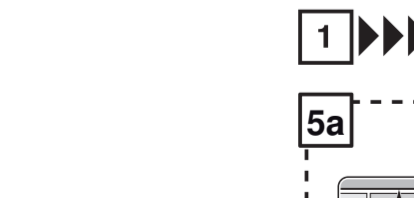
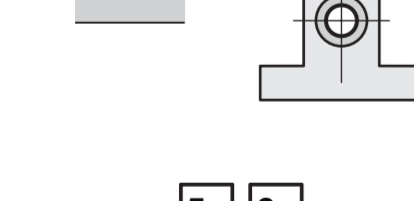
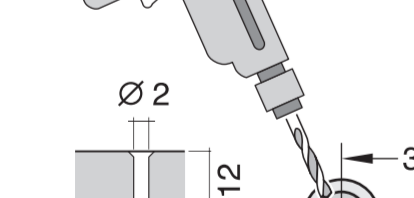
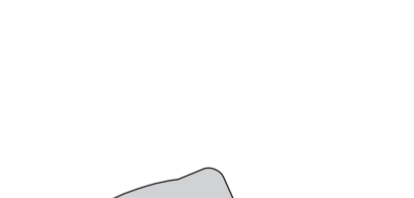
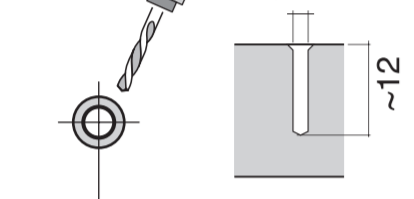
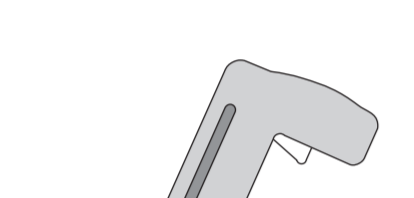
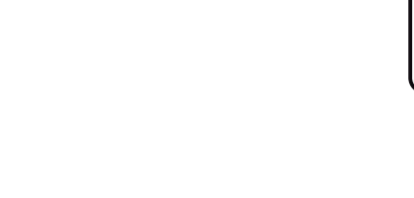
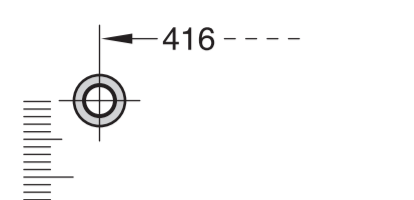

**1**

- 1
- 2
- 3 1.75 m
- 4
- 5
- 6
- 7a
- 7b
- 8
- 9

1

2

3

4

5

6

7

8

9

10

11

12

13

14

15

16

17

18

19

20

21

22

23

24

25

26

27

28

29

30

**2a**

**2b**

**3**

nicht einklemmen  
do not pinch  
ne pas coincer  
No doblar

Mat.-Nr. 10011641

1

2

3

4

5

6

7

8

9

10

11

12

13

14

15

16

17

18

19

20

21

22

23

24

25

26

27

28

29

30

**4**

**5**

verspannen  
brace  
calar verticalment  
Enrasar

SW 13

SW 10

1

2

3

4

5

6

7

8

9

10

11

12

13

14

15

16

17

18

19

20

21

22

23

24

25

26

27

28

29

30

**6**

**7**

**8**

**9**

SW 13

SW 10

1

2

3

4

5

6

7

8

9

10

11

12

13

14

15

16

17

18

19

20

21

22

23

24

25

26

27

28

29

30

**10**

Scheibe entfernen  
remove disc  
enlever le disque  
Eliminar Disco

max. 10 Nm

10 l/min

0.05 - 1 MPa  
(0.5 - 10 bar)  
max. 50°C

1

2

3

4

5

6

7

8

9

10

11

12

13

14

15

16

17

18

19

20

21

22

23

24

25

26

27

28

29

30

**5a**

**6a**

**7**

**10**

1

2

3

4

5

6

7

8

9

10

11

12

13

14

15

16

17

18

19

20

21

22

23

24

25

26

27

28

29

30

**7**

**10**

1

2

3

4

5

6

7

8

9

10

11

12

13

14

15

16

17

18

19

20

21

22

23

24

25

26

27

28

29

30

**5a**

**6a**

**7**

**10**

1

2

3

4

5

6

7

8

9

10

11

12

13

14

15

16

17

18

19

20

21

22

23

24

25

26

27

28

29

30

