

ОПЕН

Стелаж / Стеллаж _ **REG 50**
 Пенал відкритий / Пенал открытый _ **REG 1D 50**

| A | B | C | D |
|---|-----------|------|--------------|
| 1 | S133-109 | 1995 | 332 1/2; 1/3 |
| 2 | S133-110 | 1995 | 332 1/2; 1/3 |
| 3 | S133-310 | 500 | 326 2/2; 2/3 |
| 4 | S133-311 | 500 | 304 2/2; 2/3 |
| 5 | S133-403 | 500 | 76 2/2; 2/3 |
| 6 | S133-1910 | 1896 | 263 1/2; 1/3 |
| 7 | LH-1869 | 1869 | 14 1/2; 1/3 |



REG 50

REG 1D 50

REG 1D 50

| A | B | C | D |
|---|----------|-----|---------|
| 8 | S133-007 | 732 | 495 3/3 |

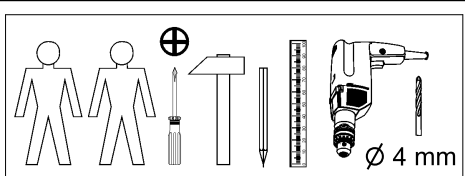
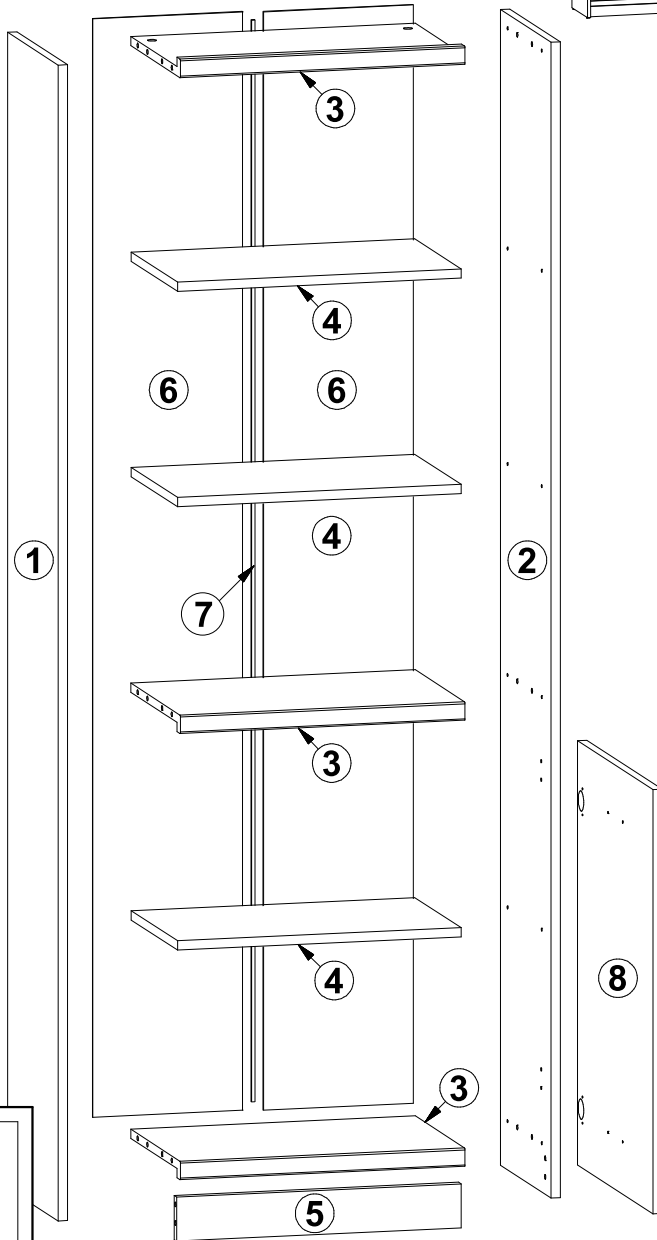

REG 50; REG 1D 50

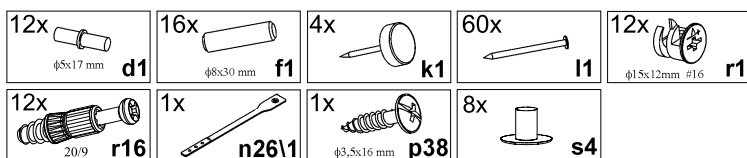

REG 1D 50

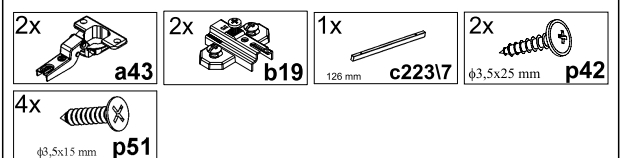

1

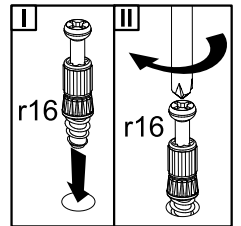
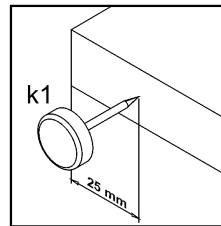
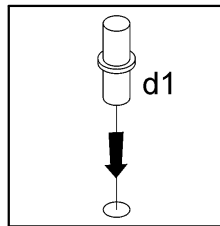
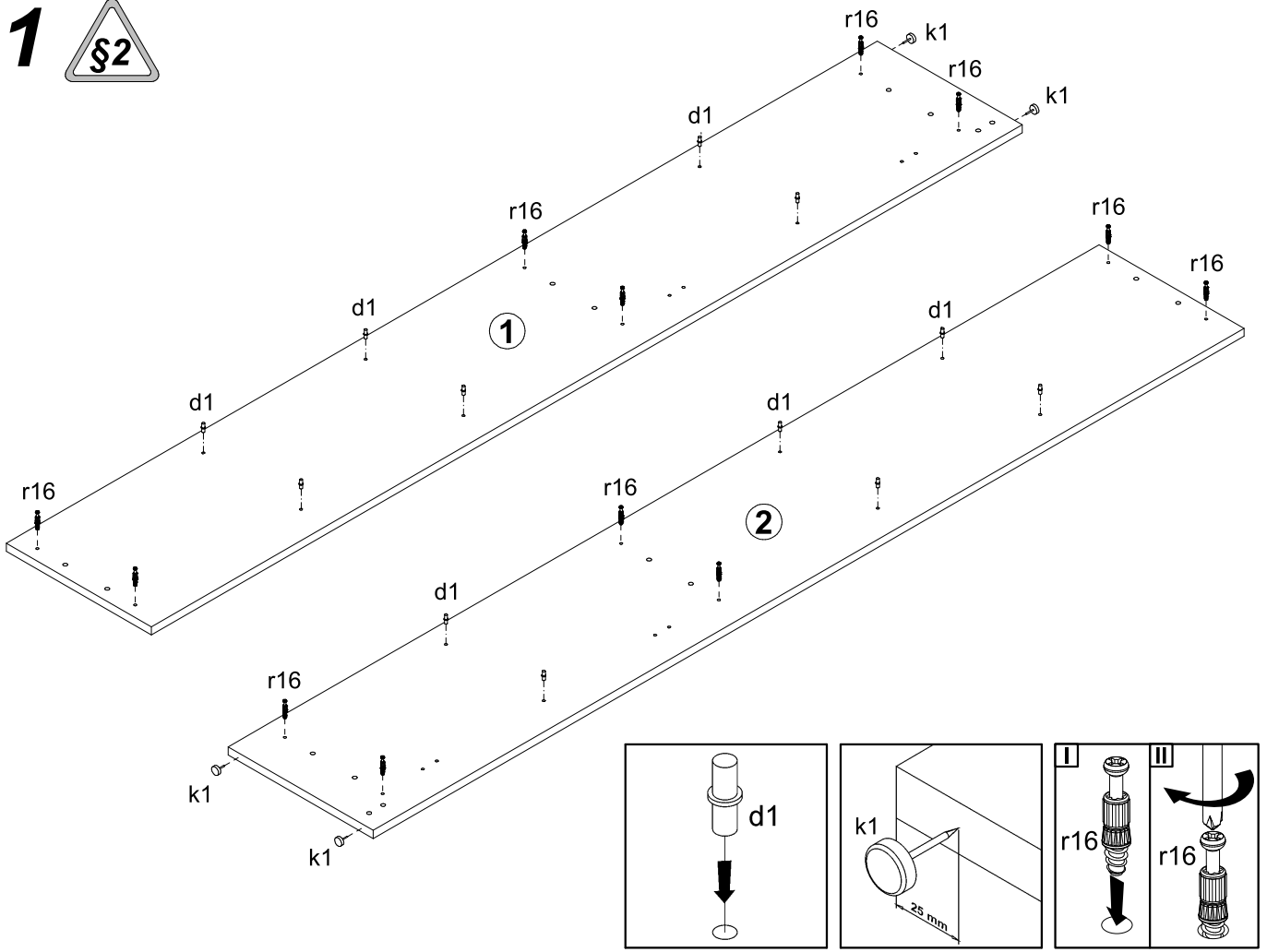

2

