

Contents

1	Instructions	56
1.1	General safety instructions	56
1.2	Appliance purpose	59
1.3	Manufacturer's liability	59
1.4	This user manual	59
1.5	Identification plate	59
1.6	Disposal	59
1.7	How to read the user manual	60
2	Description	61
2.1	General Description	61
2.2	Control panel	64
2.3	Other parts	65
2.4	Available accessories	66
3	Use	68
3.1	Instructions	68
3.2	First use	68
3.3	Using the accessories	69
3.4	Using the oven	70
3.5	Cooking advice	78
3.6	Special functions	80
3.7	Automatic programs	83
3.8	Secondary menu	86
4	Cleaning and maintenance	89
4.1	Instructions	89
4.2	Cleaning the surfaces	89
4.3	Cleaning the door	90
4.4	Cleaning the oven cavity	92
4.5	Vapor Clean (on some models only)	94
4.6	Pyrolytic (on some models only)	97
4.7	Extraordinary maintenance	99
5	Installation	102
5.1	Electrical connection	102
5.2	Cable replacement	102
5.3	Positioning	103

TRANSLATION OF THE ORIGINAL INSTRUCTIONS

We advise you to read this manual carefully, which contains all the instructions for maintaining the appliance's aesthetic and functional qualities.

For further information on the product: www.smeg.com



1 Instructions

1.1 General safety instructions

Risk of personal injury

- During use the appliance and its accessible parts become very hot. Never touch the heating elements during use.
- Protect your hands by wearing oven gloves when moving food inside the oven.
- Never try to put out a fire or flames with water: Turn off the appliance and smother the flames with a fire blanket or other appropriate cover.
- This appliance may be used by children aged at least 8 and by people of reduced physical, sensory or mental capacity, or lacking in experience in the use of electrical appliances, provided that they are supervised or instructed by adults who are responsible for their safety.
- Children must not play with the appliance.
- Keep children under the age of eight at a safe distance unless they are constantly supervised.
- Keep children under the age of 8 away from the appliance when it is in use.
- Cleaning and maintenance must not be carried out by unsupervised children.
- The cooking process must always be monitored. A short cooking process must be continuously monitored.
- Never leave the appliance unattended during cooking operations where fats or oils could be released, as these could then heat up and catch fire. Be very careful.
- Do not pour water directly onto very hot trays.
- Keep the oven door closed during cooking.
- If you need to move food or at the end of cooking, open the door 5 cm for a few seconds, let the steam come out, then open it fully.
- Do not insert pointed metal objects (cutlery or utensils) into the slots in the appliance.
- Switch off the appliance immediately after use.



- DO NOT USE OR STORE FLAMMABLE MATERIALS NEAR THE APPLIANCE.
 - DO NOT USE AEROSOLS IN THE VICINITY OF THIS APPLIANCE WHILST IT IS IN USE.
 - DO NOT MODIFY THIS APPLIANCE.
 - Have qualified personnel carry out installation and assistance interventions according to the standards in force.
 - Do not try to repair the appliance yourself or without the intervention of a qualified technician.
 - Do not pull the cable to remove the plug.
- Risk of damaging the appliance**
- Do not use abrasive or corrosive detergents (e.g. scouring powders, stain removers and metallic sponges) on glass parts. Use wooden or plastic utensils.
 - Do not use rough or abrasive materials or sharp metal scrapers.
 - Do not use cleaning products containing chlorine, ammonia or bleach on parts made of steel or that have metallic surface finishes (e.g. anodizing, nickel- or chromium-plating).
 - Racks and trays should be inserted as far as they will go into the side guides. The mechanical safety locks that prevent them from being removed must face downwards and towards the back of the oven cavity.
 - Do not seat on the appliance.
 - Do not use steam jets to clean the appliance.
 - Do not spray any spray products near the appliance.
 - Do not obstruct ventilation openings and heat dispersal slots.
 - Never leave objects on the cooking surface.
 - DO NOT FOR ANY REASON USE THE APPLIANCE AS A SPACE HEATER.
 - Do not use plastic cookware or containers when cooking food.
 - Do not put sealed tins or containers in the oven.



Instructions

- Remove all trays and racks which are not required during cooking.
- Do not cover the bottom of the oven cavity with aluminium or tin foil sheets.
- Do not place pans or trays directly on the bottom of the oven cavity.
- If you wish to use greaseproof paper, place it so that it will not interfere with the hot air circulation inside the oven.
- Do not use the open door to rest pans or trays on the internal glass pane.
- Never use the oven door to lever the appliance into place when fitting.
- Avoid exerting too much pressure on the oven door when open.
- Do not use the handle to lift or move the appliance.
- Position the appliance into the cabinet cut-out with the help of a second person.
- To avoid potential overheating, the appliance must not be installed behind a decorative door or a panel.
- Have qualified personnel carry out installation and assistance interventions according to the standards in force.
- Have the electrical connection performed by authorised technical personnel.
- The appliance must be connected to earth in compliance with electrical system safety standards.
- Use cables withstanding a temperature of at least 90 °C.
- The tightening torque of the screws of the terminal supply wires must be 1.5 - 2 Nm.

Installation and maintenance

- THIS APPLIANCE **MUST NOT BE INSTALLED** IN BOATS OR CARAVANS.
- The appliance must not be installed on a pedestal.

- If the power supply cable is damaged, contact technical support immediately and they will replace it.



- Always use any necessary/required personal protective equipment (PPE) before performing any work on the appliance (installation, maintenance, positioning or movement).
- Before performing any work on the appliance, switch off the power supply.

For this appliance

- Ensure that the appliance is switched off before replacing the bulb.
- Do not rest any weight or sit on the open door of the appliance.
- Take care that no objects are stuck in the doors.
- Do not install / use the appliance outdoors.

1.2 Appliance purpose

- This appliance is intended for cooking food in the home environment. Every other use is considered improper.
- The appliance is not designed to operate with external timers or with remote-control systems.

1.3 Manufacturer's liability

The manufacturer declines all liability for damage to persons or property caused by:

- Use of the appliance other than that specified
- Failure to comply with the instructions in the user manual
- Tampering with any part of the appliance
- The use of non-original spare parts.

1.4 This user manual

This user manual is an integral part of the appliance and must therefore be kept in its entirety and within the user's reach for the whole working life of the appliance.

Read this user manual carefully before using the appliance.

1.5 Identification plate

The identification plate bears the technical data, serial number and brand name of the appliance. Do not remove the identification plate for any reason.

1.6 Disposal



This appliance must be disposed of separately from other waste (Directives 2002/95/EC, 2002/96/EC, 2003/108/EC). The appliance does not contain substances in quantities sufficient to be considered hazardous to health and the environment, in accordance with current European directives.



Instructions

To dispose of the appliance:

- Cut the power supply cable and remove it along with the plug.



Power voltage Danger of electrocution

- Disconnect the mains power supply.
 - Unplug the appliance.
- Deliver the appliance to the appropriate recycling centre for electrical and electronic equipment waste, or return it to the retailer when purchasing an equivalent product, on a one for one basis.

Our appliances are packaged in non-polluting and recyclable materials.

- Deliver the packing materials to the appropriate recycling centre.



Plastic packaging Danger of suffocation

- Do not leave the packaging or any part of it unattended.
- Do not let children play with the plastic bags.

1.7 How to read the user manual

This user manual uses the following reading conventions:

Instructions



General information on this user manual, on safety and final disposal.

Description



Description of the appliance and its accessories.

Use



Information on the use of the appliance and its accessories, cooking advice.

Cleaning and maintenance



Information for proper cleaning and maintenance of the appliance.

Installation



Information for the qualified technician: Installation, operation and inspection.



Safety instructions



Information



Advice

1. Sequence of instructions for use.

- Standalone instruction.



2 Description

2.1 General Description

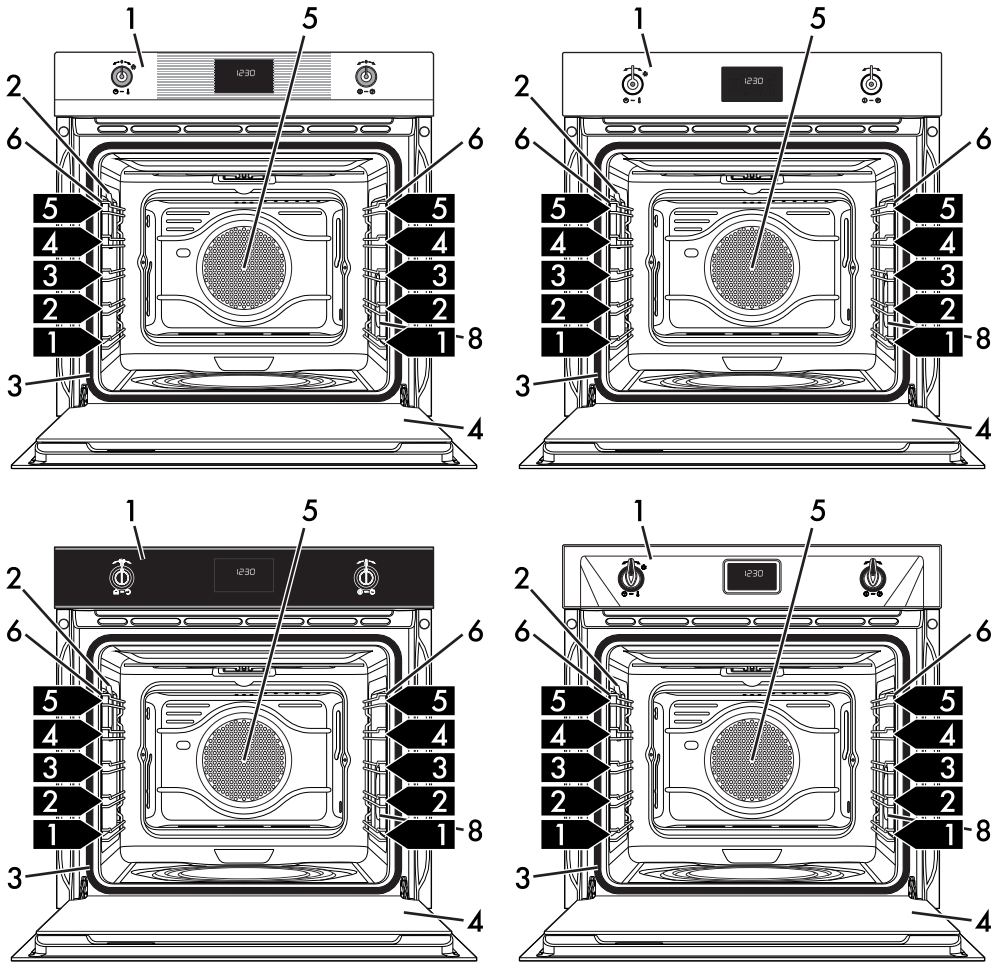

Multifunction and Pyrolytic models



Description

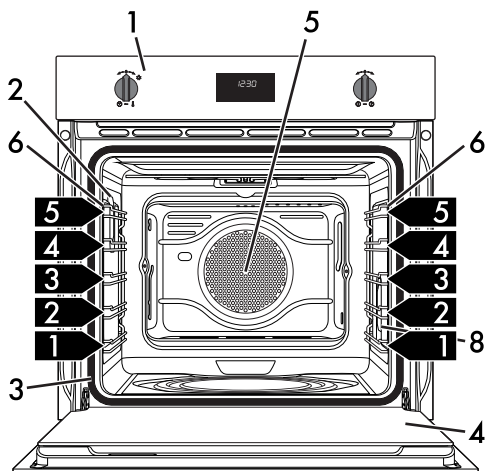

Multifunction and Pyrolytic models

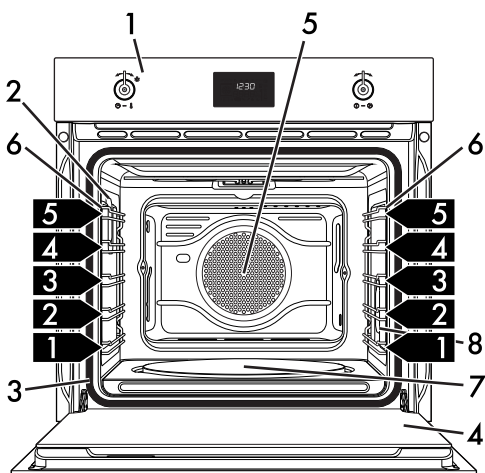
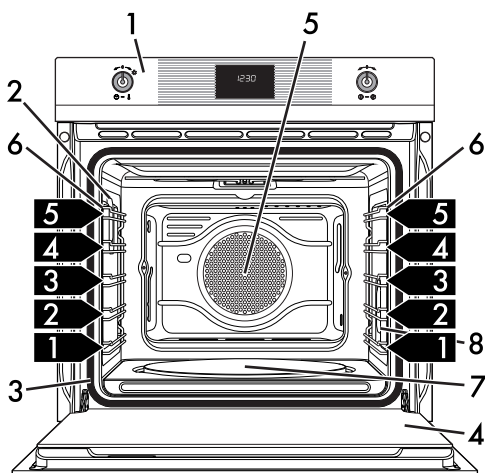

Models with Pizza stone

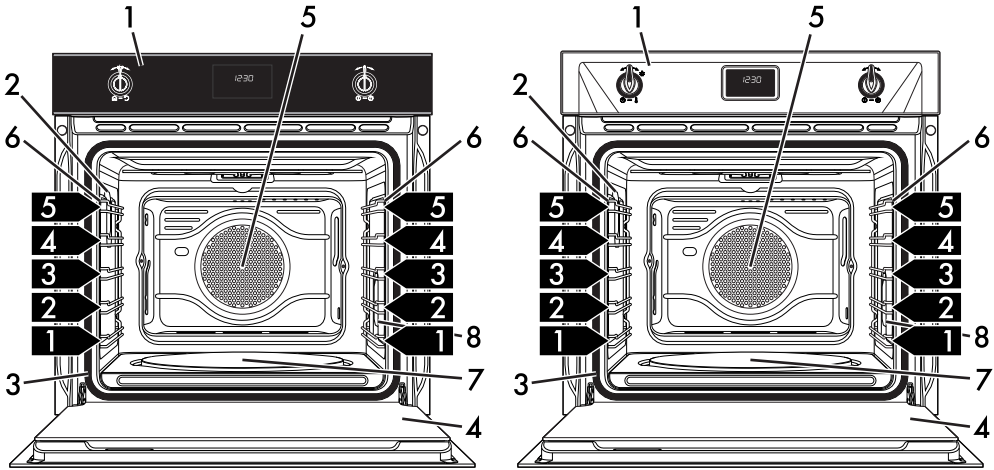

EN

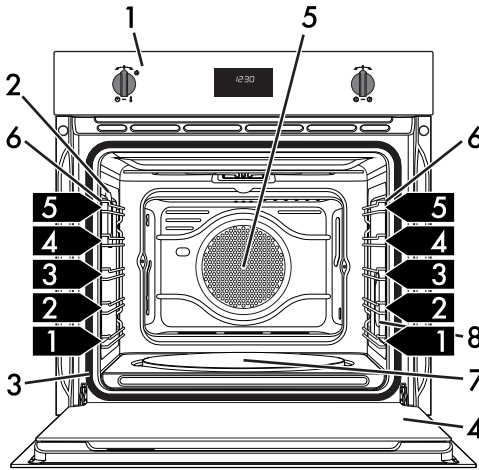

Models with Pizza stone

- 1 Control panel
- 2 Oven light
- 3 Seal
- 4 Door
- 5 Fan

- 6 Rack/tray support frames
- 7 Pizza stone (on some models only)
- 8 Light (on some models only)

1,2,3 Frame shelf



Description

2.2 Control panel

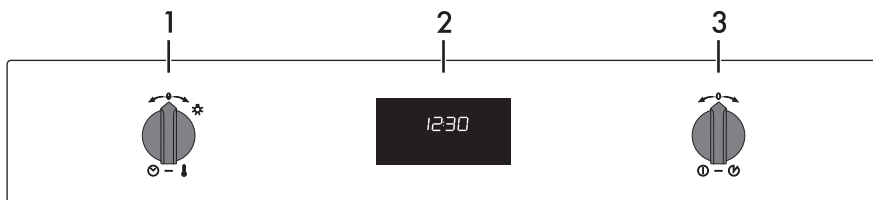
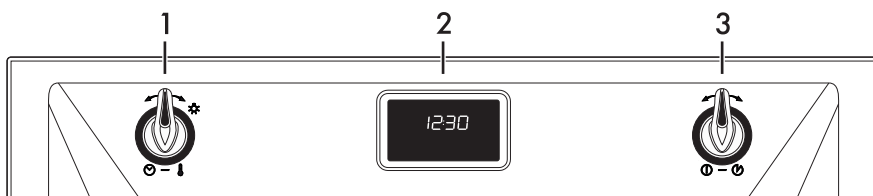
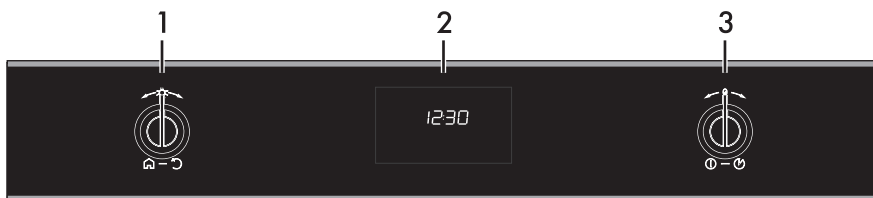
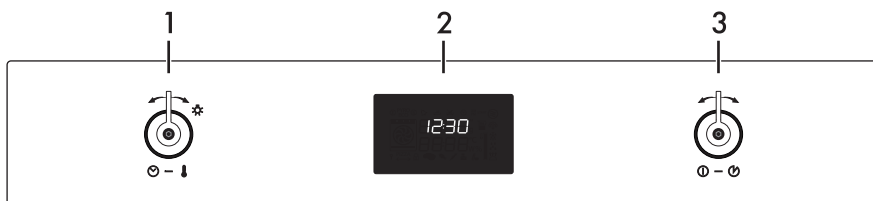
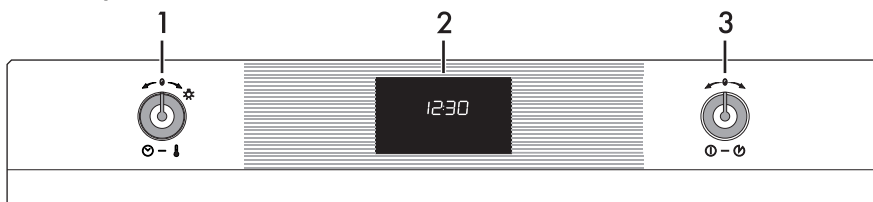



1 Temperature knob

This knob allows you to select the cooking time and temperature, set programmed cooking and the current time as well as turn the light inside the oven on and off.

2 Display

Displays the current time, the selected cooking temperature and function and any time set.

3 Function knob

This knob allows you to turn the appliance on and off and select the cooking function.

2.3 Other parts

Cooling fan

The fan cools the appliance and comes into operation during cooking.

The fan causes a steady outflow of air from above the door which may continue for a brief period of time even after the appliance has been turned off.

Interior lighting

The appliance's interior lighting comes on:

- When the door is opened.
- When any function is selected, apart

from the **ECO**  and **Vapor Clean**  functions (Multifunction models) and the

Pyrolytic **PYRO**  and **ECO Pyrolytic** **PYRO**  functions (Pyrolytic models).

- When the temperature knob is briefly turned to the right (manual activation and deactivation).

 When the door is open, it is not possible to turn off the interior lighting.

Shelves

The appliance features shelves to position trays and racks at different heights. The insertion heights are indicated from the bottom upwards (see 2.1 General Description).



Description

2.4 Available accessories



Some models are not provided with all accessories.

Rack

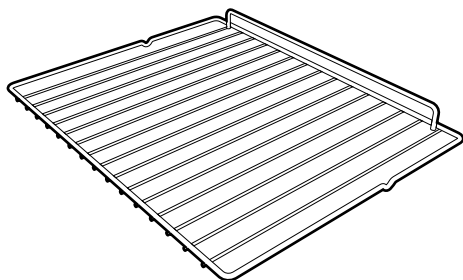

Useful for supporting containers with food during cooking.

Tray rack

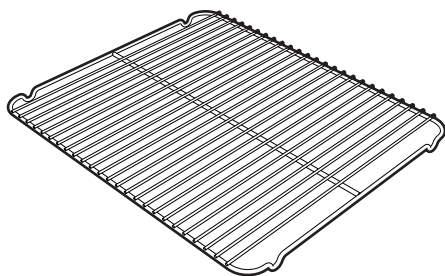

To be placed over the top of the oven tray; for cooking foods which may drip.

Oven tray (on some models only)

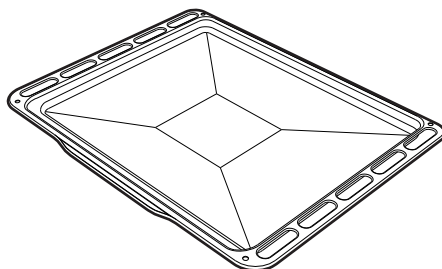

Useful for collecting fat from foods placed on the rack above.

Deep tray

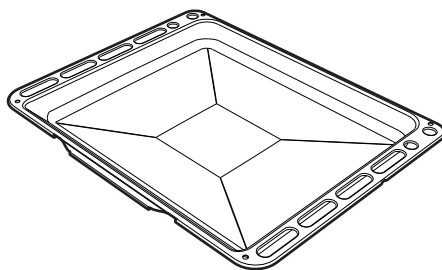

Useful for collecting fat from foods placed on the rack above and for cooking pies, pizzas and baked desserts.

Description



Pizza stone (on some models only)

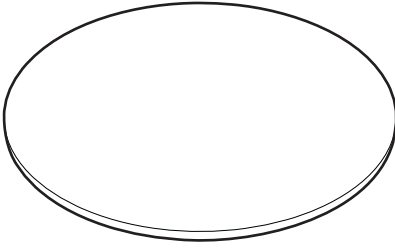

Specially designed for cooking pizza and similar dishes.

Pizza spatula (on some models only)

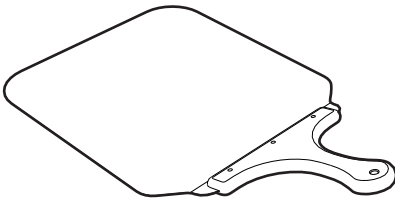

For easily placing the pizza on the pizza stone.

Pizza stone cover (on some models only)

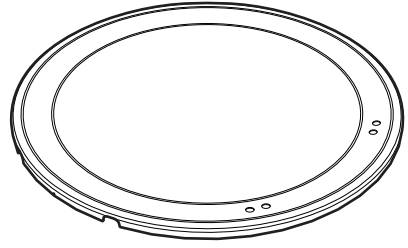

To be placed in the housing on the base of the oven in place of the pizza stone when this is not being used.

i The oven accessories intended to come into contact with food are made of materials that comply with the provisions of current legislation.

i Original supplied and optional accessories can be requested to Authorised Assistance Centres. Use only original accessories supplied by the manufacturer.



3 Use

3.1 Instructions



Improper use

Risk of damage to surfaces

- Do not cover the bottom of the oven cavity with aluminium or tin foil sheets.
- If you wish to use greaseproof paper, place it so that it will not interfere with the hot air circulation inside the oven.
- Do not place pans or trays directly on the bottom of the oven cavity.
- Do not pour water directly onto very hot trays.



High temperature inside the oven during use

Danger of burns

- Keep the oven door closed during cooking.
- Protect your hands by wearing oven gloves when moving food inside the oven.
- Do not touch the heating elements inside the oven.
- Do not pour water directly onto very hot trays.
- Do not allow children to approach the appliance when it is in operation.



High temperature inside the oven during use

Danger of fire or explosion

- Do not spray any spray products near the appliance.
- Do not use or leave flammable materials near the appliance.
- Do not use plastic cookware or containers when cooking food.
- Do not put sealed tins or containers in the oven.
- Do not leave the appliance unattended during cooking operations where fats or oils could be released.
- Remove all trays and racks which are not required during cooking.

3.2 First use

1. Remove any protective film from the outside or inside of the appliance, including accessories.
2. Remove any labels (apart from the technical data plate) from the accessories and from the oven cavity.
3. Remove and wash all the appliance accessories (see 4 Cleaning and maintenance).
4. Heat the empty oven at the maximum temperature to burn off any residues left by the manufacturing process.



3.3 Using the accessories

Racks and trays

Racks and trays have to be inserted into the side guides until they come to a complete stop.

- The mechanical safety locks that prevent the rack from being taken out accidentally have to face downwards and towards the oven back.

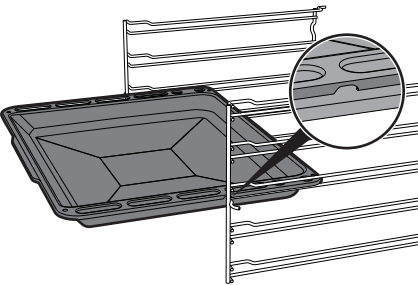
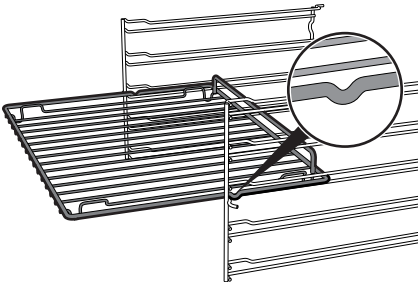

Gently insert racks and trays into the oven until they come to a stop.



Clean the trays before using them for the first time to remove any residues left by the manufacturing process.

Tray rack

The tray rack has to be inserted into the tray. In this way fat can be collected separately from the food which is being cooked.

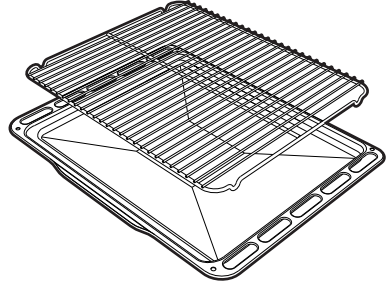

Pizza spatula (on some models only)

Always hold the pizza spatula by the handle to put food in and take it out of the oven. You are advised to dust the steel surface lightly with flour to make it easier to slide fresh products on and off, as they could stick to the steel due to their moisture content.

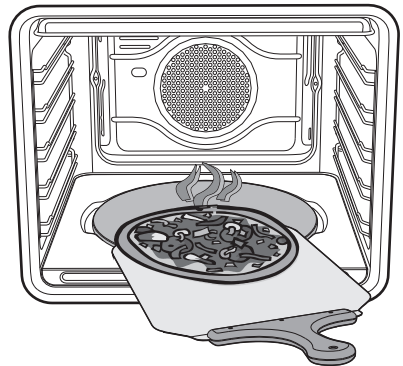



Use

Cover and pizza stone (on some models only)



Improper use
Risk of damage to surfaces

- Do not use the pizza stone other than as described, for example do not use it on gas or glass ceramic hobs or in ovens which are not designed for this purpose.
- If you like oil on your pizza, it is best to add it after removal from the oven since oil stains on the pizza stone are unsightly and may reduce its efficiency.
- If the pizza stone is not in use, cover the bottom of the oven with the cover provided.

With the oven cold, remove the cover from the bottom and insert the pizza stone. Make sure that the stone is inserted correctly in the recess provided.

For cooking, use the special  + **PIZZA** function.

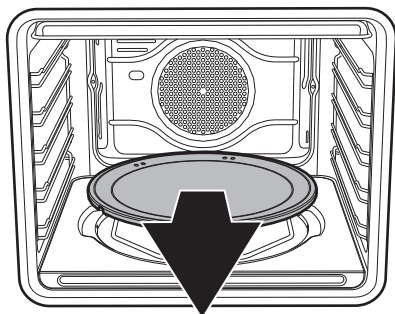

3.4 Using the oven

Display

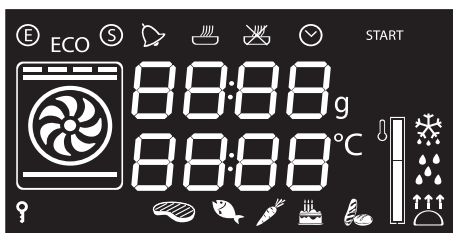

Multifunction models

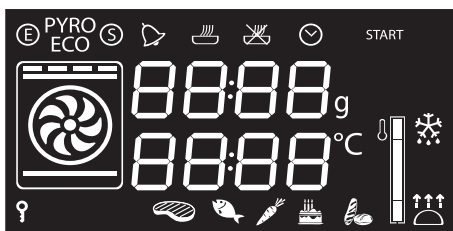

Pyrolytic models

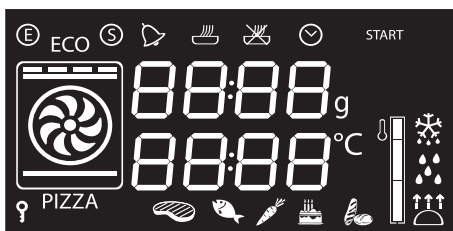



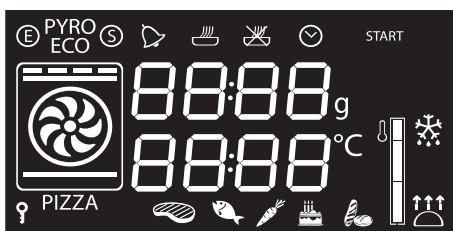







Multifunction models with Pizza stone



Pyrolytic models with Pizza stone



-  Eco-logic indicator light
-  Pyrolytic function indicator light (pyrolytic models only)
-  Showroom indicator light
-  Minute minder timer indicator light
-  Timed cooking indicator light
-  Programmed cooking indicator light
-  Clock indicator light
-  Child lock indicator light
-  **PIZZA** Pizza function indicator light (only on models with Pizza stone)



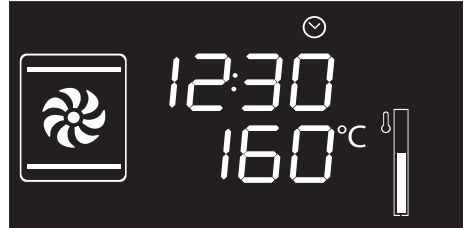

-  Door lock indicator light (pyrolytic models only)

-  Temperature level reached

ON: When a function is activated, the display shows the parameters set such as temperature, duration and temperature reached.



Each time the temperature knob is pressed during a function, the parameters will be cycled through in the following order.

-  °C Temperature
-  Minute minder timer duration
-  Function duration
-  Programmed cooking duration (if timed cooking has been selected)
-  Time display

Operating modes

Stand-by: When no function is selected, the display shows the current time.

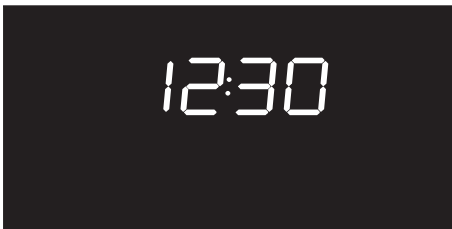

In all modes it is possible to modify the value by turning the temperature knob to the left or right. Keep the knob turned to produce a faster increase or decrease.



Use

Setting the time

When using the appliance for the first time, or after a power failure, the  symbol will flash on the display. To be able to start any cooking function, the current time must be set.

1. Turn the temperature knob to set the displayed time (keep the knob turned to produce a faster increase or decrease).
2. Press the temperature knob.
3. Turn the temperature knob to set the minutes (keep the knob turned to produce a faster increase or decrease).
4. Press the temperature knob to finish adjustment.



It may become necessary to change the current time, for example for daylight saving time. From the stand-by position, keep the temperature knob turned to the right or left until the hours flash. It is not possible to change the time if the oven is **ON**.

Cooking functions

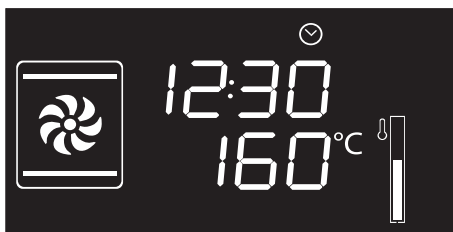

1. Select a cooking function with the function knob.
2. Press and turn the temperature knob to modify the cooking temperature.
3. Press the function knob to start traditional cooking.



A function can be interrupted at any time by pressing and holding the function knob for at least 3 seconds.

Preheating stage

Cooking itself is preceded by a preheating stage, which allows the appliance to heat to the cooking temperature more quickly.

The temperature reached flashes to indicate that this stage is in progress.



When the preheating stage is complete, temperature level reached indication will remain lit steadily and a buzzer sounds to indicate that the food can be placed inside the oven.





Functions list



ECO

This function is particularly suitable for cooking on a single shelf with low energy consumption.

Ideal for cooking meat, fish and vegetables. It is not recommended for leavened foods.

To obtain maximum energy savings and reduce cooking times, it is recommended to place food in the oven without preheating.



When using the ECO function, avoid opening the door during cooking.



Cooking (and preheating) times are longer with the ECO function.



Static

As the heat comes from above and below at the same time, this system is particularly suitable for certain types of food. Traditional cooking, also known as static cooking, is suitable for cooking just one dish at a time. Perfect for all types of roasts, bread and cakes, and in any case, particularly suitable for fatty meats such as goose and duck.



Grill

The heat coming from the grill element gives perfect grilling results above all for thin and medium thickness meat and, in combination with the rotisserie (where fitted), gives the food an even browning at the end of cooking. Perfect for sausages, spare ribs and bacon. This function enables large quantities of food, particularly meat, to be grilled evenly.



Lower element

The heat coming just from the bottom allows you to complete the cooking of foods that require a higher bottom temperature, without affecting their browning. Perfect for cakes, pies, tarts and pizzas.



Fan assisted

The operation of the fan, combined with traditional cooking, ensures consistent cooking even with complex recipes. Perfect for biscuits and cakes, even when simultaneously cooked on several levels. (For multiple-level cooking, we recommend using the 2nd and 4th shelf).



Fan with grill

The air produced by the fan softens the strong heatwave generated by the grill, grilling perfectly even very thick foods. Perfect for large cuts of meat (e.g. shin of pork).



Use



Fan + lower element

The combination of the fan with just the lower heating element allows cooking to be completed more rapidly. This system is recommended for sterilising or for finishing off the cooking of foods which are already well-cooked on the surface, but not inside, which therefore need a little more heat. Perfect for any type of food.



Pizza (on some models only)



The operation of the fan, combined with the grill and the lower heating element, ensures consistent cooking even with complex recipes. Perfect not just for pizzas, but also for biscuits and cakes.



Circulaire

The combination of the fan and the circulaire heating element (incorporated in the rear of the oven cavity) allows you to cook different foods on several levels, as long as they require the same temperature and type of cooking. Hot air circulation ensures instant and even distribution of heat. It will be possible, for instance, to cook fish, vegetables and biscuits simultaneously (on different levels) without odours and flavours mingling.



Turbo

The combination of fan assisted cooking and traditional cooking allows different foods to be cooked on several levels extremely quickly and efficiently, without odours and flavours mingling. Perfect for large volumes that call for intense cooking.





Minute minder

i This function only activates the buzzer, without stopping cooking.

i The minute minder can be activated both during cooking and when the appliance is in standby.

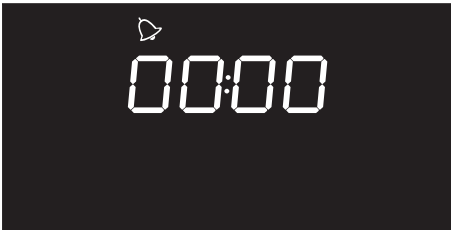
1. Press the temperature knob once (twice if cooking is already in progress). The display shows **00:00** and the indicator light  flashes.



2. Turn the knob to set the duration (from 1 minute to 4 hours). After a few seconds, the indicator light  stops flashing and the countdown starts.
3. Select the required cooking function and wait for the buzzer to sound, indicating that the cooking time is over. The indicator light  flashes.

4. To deactivate the buzzer, press or turn one of the two knobs.
5. To select a further minute minder, turn the temperature knob.

 You must set the value to zero to remove the minute minder timer.

Timed cooking

i Timed cooking is the function which allows a cooking operation to be started and then ended after a specific length of time set by the user.

i Activation of timed cooking cancels any minute minder timer which may previously have been set.

1. After selecting a cooking function and temperature, press the temperature knob three times. The display shows **00:00** and the indicator light  flashes.

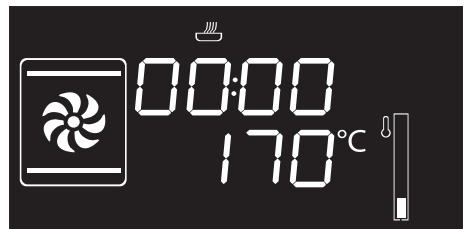



Use

2. Turn the temperature knob right or left to set the cooking duration from 00:01 to 12:59. Keep the knob turned to produce a faster increase or decrease.

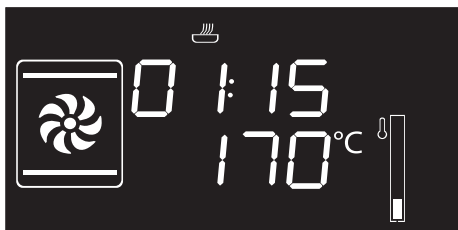

3. A few seconds after the required duration is set, the indicator light  stops flashing and timed cooking starts.



To extend the cooking time manually, press the temperature knob again. The appliance will resume its normal operation with the previously selected cooking settings.

4. At the end of cooking, **Stop** is shown on the display and a buzzer sounds.



5. To deactivate the buzzer, press or turn one of the two knobs or open the door.



To deactivate the buzzer and select a further timed cooking, turn the temperature knob to the right.





To deactivate the buzzer and select a different cooking function, turn the function knob to the right or left.



Press and hold the function knob down to switch off the appliance.

Modifying the data set during timed cooking

During operation, it is possible to modify timed cooking duration:

1. When the indicator light  is steady and cooking is in progress inside the appliance, press the temperature knob twice. The indicator light  starts flashing.
2. Turn the temperature knob right or left to change the previously set cooking duration.



Programmed cooking

i Programmed cooking is the function which allows cooking to be stopped at an established time depending on the time set by the user, after which the appliance will switch off automatically.

1. After selecting a cooking function and temperature, press the temperature knob three times. The display shows

00:00 and the indicator light  flashes.

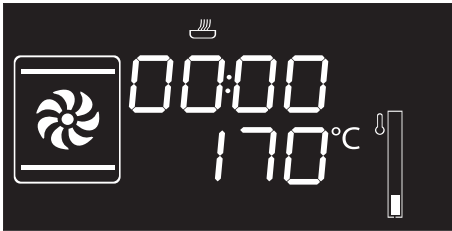

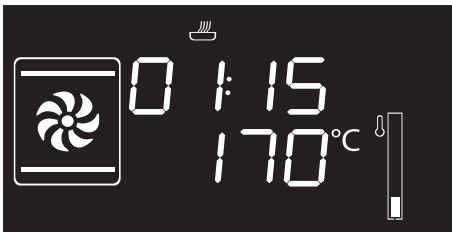

2. Turn the knob right or left to set the cooking duration from 00:01 to 12:59. Keep the knob turned to increase or decrease it more quickly.



3. Press the temperature knob a fourth time.

The indicator light  flashes. Turn the knob right or left to set the cooking end time.

4. After a few seconds the indicator lights  and  stop flashing. The appliance waits for the set start time.

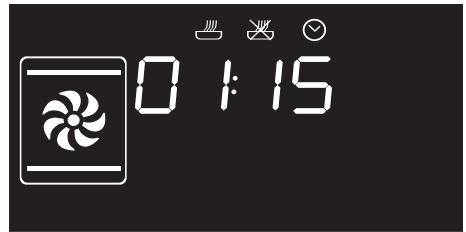

To extend the cooking time manually, press the temperature knob again. The appliance will resume its normal operation with the previously selected cooking settings.



With programmed cooking, the oven is switched on ten minutes in advance to allow the appliance to reach the cooking temperature (preheating).



5. At the end of cooking, **STOP** is shown on the display and a buzzer sounds.



6. To deactivate the buzzer, press or turn one of the two knobs or open the door.



Press and hold the function knob down to switch off the appliance.









For safety reasons, it is not possible to set the end of cooking time by itself without setting the cooking duration.

Modifying the data set during programmed cooking



After modifying the cooking duration, the end of cooking time must be re-set.

During operation, it is possible to modify programmed cooking duration:

1. When the indicator lights  and  are lit steadily and the appliance is waiting for cooking to start, press the temperature knob twice. The indicator light  starts flashing.
2. Turn the temperature knob right or left to change the previously set cooking duration.
3. Press the temperature knob again. The indicator light  switches off and the indicator light  starts flashing. The display shows the cooking end time.
4. Turn the temperature knob right or left to delay the cooking end time.
5. After a few seconds the indicator lights  and  stop flashing and programmed cooking resumes its operation with the new settings.

3.5 Cooking advice

General advice

- Use a fan assisted function to achieve consistent cooking at several levels.
- It is not possible to shorten cooking times by increasing the temperature (the food could be overcooked on the outside and undercooked on the inside).



Advice for cooking meat

- Cooking times vary according to the thickness and quality of the food and to consumer taste.
- Use a meat thermometer when roasting meat, or simply press on the roast with a spoon. If it is hard, it is ready; If not, it needs another few minutes cooking.

Advice for cooking with the Grill and the Fan with grill

- Meat can be grilled even when it is put into the cold oven or into the preheated oven if you wish to change the effect of the cooking.
- With the Fan with grill function, we recommend that you preheat the oven before grilling.
- We recommend placing the food at the centre of the rack.

Advice for cooking desserts/pastries and biscuits

- Use dark metal moulds: They help to absorb the heat better.
- The temperature and the cooking time depend on the quality and consistency of the dough.
- To check whether the dessert is cooked right through: At the end of the cooking time, put a toothpick into the highest point of the dessert. If the dough does not stick to the toothpick, the dessert is cooked.
- If the dessert collapses when it comes out of the oven, on the next occasion reduce the set temperature by about 10°C, selecting a longer cooking time if necessary.

Advice for defrosting and proving

- Place frozen foods without their packaging in a lidless container on the first shelf of the oven.
- Avoid overlapping the food.
- To defrost meat, use the rack placed on the second level and a tray on the first level. In this way, the liquid from the defrosting food drains away from the food.
- The most delicate parts can be covered with aluminium foil.
- For successful proving, a container of water should be placed in the bottom of the oven.

To save energy

- Stop cooking a few minutes before the time normally used. Cooking will continue for the remaining minutes with the heat which has accumulated inside the oven.
- Reduce any opening of the door to a minimum to avoid heat dispersal.
- Keep the inside of the appliance clean at all times.
- (Where fitted) When it is not being used, remove the pizza stone and put the cover back in its slot.



3.6 Special functions

Defrost by time

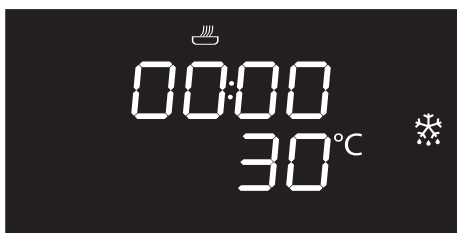

1. Place the food inside the oven.
2. Press and turn the function knob to select the defrost by time function .
3. Turn the temperature knob to set the duration (from 1 to 99 minutes).
4. Press the temperature knob to confirm the set duration. **START** flashes.
5. Press the function knob to start the defrost by time function.
6. At the end, **StoP** is displayed and a buzzer sounds.
7. To deactivate the buzzer, press or turn one of the two knobs or open the door.
8. Press and hold the function knob for at least 3 seconds to exit the function.

Proving

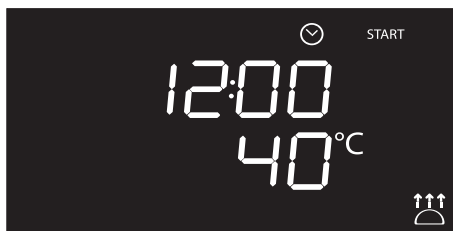

When using the proving function the temperature cannot be altered.



For successful proving, a container of water should be placed in the bottom of the oven.

1. Position the dough for proving on the second shelf.
2. Press and turn the function knob to select the proving function .
3. Press the function knob to start the proving function. **START** flashes.
3. Press the function knob to start the proving function.
4. At the end, **StoP** is displayed and a buzzer sounds.
5. To deactivate the buzzer, press or turn one of the two knobs or open the door.
6. Press and hold the function knob for at least 3 seconds to exit the function.



Sabbath



This function allows food to be cooked in accordance with the provisions of the Jewish religion day of rest.



This function results in the appliance operating in a particular way:

- Cooking can proceed indefinitely, it is not possible to set any time.
- No preheating will be performed.
- The cooking temperature which can be selected varies between 60-100 °C.
- Oven light disabled, any operation such as opening the door or manual activation with the knob will not activate the light.
- The internal fan remains turned off.
- Knob illumination and audible prompts remain disabled.



After activating the Sabbath function the settings cannot be altered.

Any action on the knobs will produce no effect; only the function knob remains active to allow the appliance to be turned off.

1. Press and turn the function knob to select the Sabbath function **SAbb**.
2. Press and turn the temperature knob to modify the temperature of the function.
3. Press the temperature knob to confirm the set temperature. **START** flashes.
4. Press the function knob to start the Sabbath function.
5. Press and hold the function knob for at least 3 seconds to exit the function.



Use

Defrost by weight

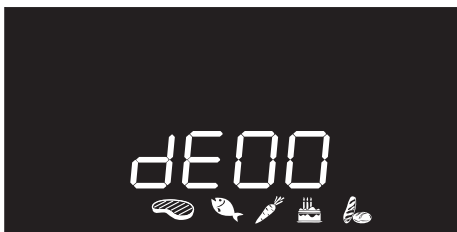

This function defrosts foods on the basis of the type and weight of the frozen products.

1. Place the food inside the oven.
2. Press and turn the function knob to select defrost by weight, marked by **dE00** and the illuminated food symbols
3. Press the function knob to confirm the defrost by weight function.
4. Turn the function knob to select the type of food to defrost.

5. Turn the temperature knob to select the weight (in grams) of the food to defrost.
6. Press the function knob to confirm the set parameters and start defrosting.
7. At the end, **Stop** is displayed and a buzzer sounds.
8. To deactivate the buzzer, press or turn one of the two knobs or open the door.
9. Press and hold the function knob for at least 3 seconds to exit the function.

Pre-set parameters

dE	Type	Weight (g)	Time (min)*
01	Meat	500	120
02	Fish	300	55
03	Fruit	300	35
04	Bread	300	25

* Defrosting times may vary according to the shape and size of the food to be defrosted.



3.7 Automatic programs

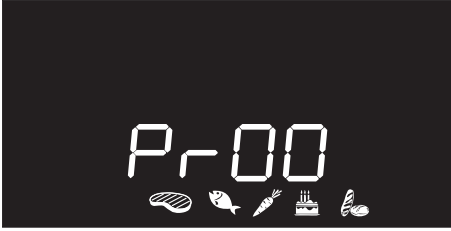

The automatic cooking programs are divided up according to the type of dish to be cooked.

1. Press and turn the function knob to select cooking with automatic programs, marked by **Pr-00** and the illuminated food symbols .
2. Press the function knob to confirm cooking with automatic programs.
3. Turn the function knob to select the preferred program (see Automatic programs table).
4. Turn the temperature knob to select the weight (in grams) of the food to cook.

5. When preheating has finished,

START will flash. Introduce the food and then press the function knob to start cooking.

6. At the end, **Stop** is displayed and a buzzer sounds.
7. To deactivate the buzzer, press or turn one of the two knobs or open the door.
8. Press and hold the function knob for at least 3 seconds to exit the function.



It is possible to set programmed cooking in automatic programs.



A function can be interrupted at any time by pressing and holding the function knob for at least 3 seconds.



Use

Automatic programs table



MEAT (01 - 05)

Pr	Subcategory	Weight (g)	Level	Function	Temperature (°C)	Time (minutes)
01	Roast beef (medium)	1000	2		200	40
02	Roast pork	1000	2		190	75
03	Lamb (well done)	1000	2		190	110
04	Veal	1000	2		190	65
05	Whole roast chicken	1000	2		200	64



FISH (06 - 07)

Pr	Subcategory	Weight (g)	Level	Function	Temperature (°C)	Time (minutes)
06	Fresh fish (whole)	500	2		160	35
07	Frozen fish	500	2		160	45



VEGETABLES (08 - 10)

Pr	Subcategory	Weight (g)	Level	Function	Temperature (°C)	Time (minutes)
08	Mixed grilled	500	4		250	15 + 10 ⁽¹⁾
09	Roasted	1000	2		200	45
10	Roasted potatoes	1000	2		220	40

⁽¹⁾ When grilling, it is recommended to cook foods on both sides, making reference to the times given in the table. The greater time always refers to the first side to be cooked, starting with raw foodstuffs.



DESSERTS/PASTRIES (11 - 13)

Pr	Subcategory	Weight (g)	Level	Function	Temperature (°C)	Time (minutes)
11	Biscuits	600	2		160	18
12	Muffins	500	2		160	18
13	Tart	800	2		170	40



BREAD - PIZZA - PASTA (14-20)

Pr	Subcategory	Weight (g)	Level	Function	Temperature (°C)	Time (minutes)
14	Leavened bread (loaf)	1000	2		200	30
15	Pan baked pizza	1000	1		280	7
16	Stone baked pizza	500	1 ⁽²⁾		280	4
17	Pasta bake	2000	1		220	40
18	Lasagne	2000	1		230	35
19	Paella	500	2		190	25
20	Quiche	1000	1		200	40

⁽²⁾ (Models without Pizza stone) The stone must be placed on the bottom of the oven. Frozen pizza cooked on the stone does not require different cooking times depending on weight.



The times indicated in the tables do not include preheating times and refer to cooking whole pieces. If the foodstuffs are cut into smaller portions, the cooking times will decrease.



3.8 Secondary menu

The appliance has a drop-down secondary menu allowing the user to:

- Activate or deactivate the Child lock.
- Activate or deactivate Showroom mode (which disables all the heating elements so that only the control panel works).
- Activate or deactivate Low Power (Eco-Logic) mode.
- Activate or deactivate Keep Warm mode.
- Activate or deactivate Timed light (Eco-light) mode.

With the appliance in Stand-By

1. Activate the internal light by turning the temperature knob quickly.
2. Press and hold the temperature knob down for at least 5 seconds.
3. Turn the temperature knob right or left to change the setting status (ON/OFF).
4. Press the temperature knob to move to the next mode.

Child lock mode

This mode allows the appliance to lock the controls automatically after one minute of normal operation without any intervention from the user.

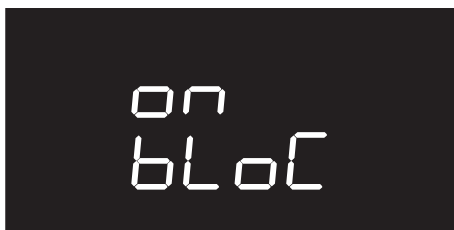
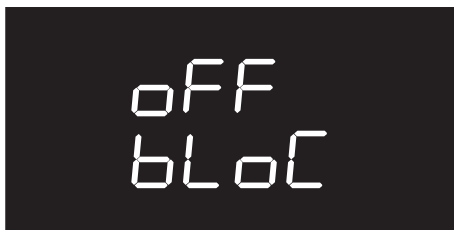

During normal operation it is indicated by the indicator light  coming on.

To release the lock temporarily during cooking, hold the temperature knob down for 5 seconds. One minute after the last setting the lock will become active again.



When the position of the knobs is changed, the display will show

bLoC for a few seconds.



It is still possible to turn the appliance off instantaneously by pressing and holding the function knob down for 3 seconds when in child lock mode.



Showroom mode (for exhibitors only)

This mode allows the appliance to deactivate all heating elements, while keeping the control panel active.



To use the appliance normally, set this mode to OFF.



If the mode is active, the indicator light  lights up on the display.

Low Power (Eco-logic) mode

This mode allows the appliance to limit the power used.

Suitable for simultaneous use with further home appliances.

HI: normal power.



LO: low power.

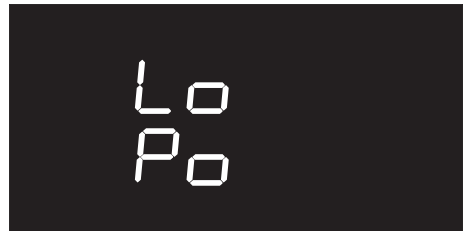

Activating eco-logic mode means that preheating and cooking times may be extended.



If the mode is active, the indicator light  lights up on the display.



Use

Keep Warm mode

This mode allows the appliance to keep cooked food warm (at low temperatures) for around an hour after cooking finishes with a cooking cycle for which a duration has been set (if this is not manually interrupted).

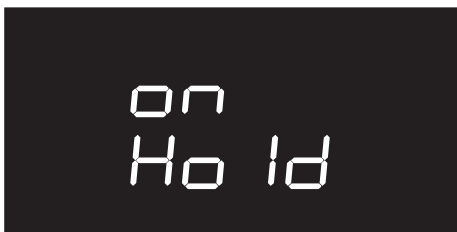

Timed light (Eco-light) mode

For greater energy savings, the light is automatically deactivated one minute from the start of cooking.



To stop the appliance from automatically deactivating the light after one minute, set this mode to OFF.



The manual off/on control is always available with both settings by turning the temperature knob to the right.



4 Cleaning and maintenance

4.1 Instructions



Improper use
Risk of damage to surfaces

- Do not use steam jets to clean the appliance.
- Do not use cleaning products containing chlorine, ammonia or bleach on parts made of steel or that have metallic surface finishes (e.g. anodizing, nickel- or chromium-plating).
- Do not use abrasive or corrosive detergents (e.g. scouring powders, stain removers and metallic sponges) on glass parts.
- Do not use rough or abrasive materials or sharp metal scrapers.



We recommend the use of cleaning products distributed by the manufacturer.

4.2 Cleaning the surfaces

To keep the surfaces in good condition, they should be cleaned regularly after use. Let them cool first.

Ordinary daily cleaning

Always and only use specific products that do not contain abrasives or chlorine-based acids.

Pour the product onto a damp cloth and wipe the surface, rinse thoroughly and dry with a soft cloth or a microfibre cloth.

Food stains or residues

Do not use steel sponges and sharp scrapers as they will damage the surface.

Use normal, non-abrasive products and a wooden or plastic tool, if necessary. Rinse thoroughly and dry with a soft cloth or a microfibre cloth.

Do not allow residues of sugary foods (such as jam) to set inside the oven. If left to set for too long, they might damage the enamel lining of the oven.



Cleaning and maintenance

4.3 Cleaning the door

Removing the door

For easier cleaning it is recommended to remove the door and place it on a tea towel.

To remove the door proceed as follows:

1. Open the door completely and insert two pins into the holes on the hinges indicated in the figure.

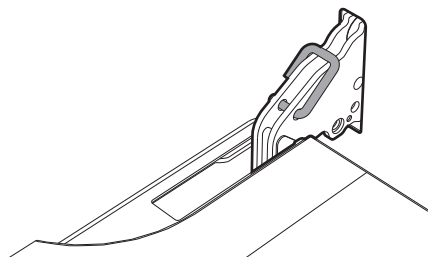

2. Grasp the door on both sides with both hands, lift it so that it forms an angle of around 30° and remove it.

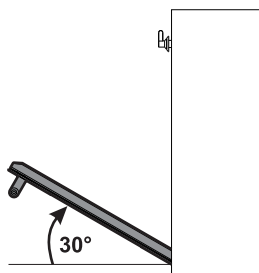

3. To reassemble the door, put the hinges in the relevant slots in the oven, making sure that grooved sections **A** are resting completely in the slots. Lower the door and once it is in place remove the pins from the holes in the hinges.

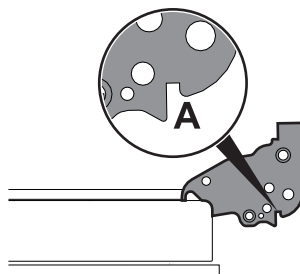

Cleaning the door glazing

The glass in the door should always be kept thoroughly clean. Use absorbent kitchen roll. In case of stubborn dirt, wash with a damp sponge and an ordinary detergent.



We recommend the use of cleaning products distributed by the manufacturer.



Removing the internal glass panes

For easier cleaning the internal glass panes of the door can be removed.

1. Remove the internal glass pane by pulling the rear part gently upwards, following the movement indicated by the arrows (1).
2. Then, pull the front part upwards (2). This way, the 4 pins attached to the glass detach from their housings in the oven door.

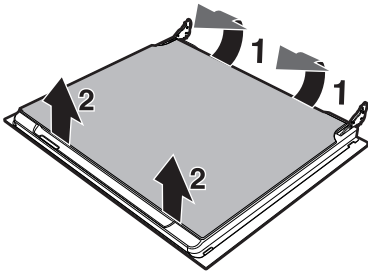

3. Some models have an intermediate glass pane. Remove the intermediate glass pane by lifting it upwards.

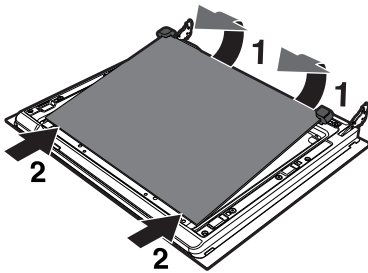

4. Clean the external glass pane and the panes removed previously. Use absorbent kitchen roll. In case of stubborn dirt, wash with a damp sponge and neutral detergent.

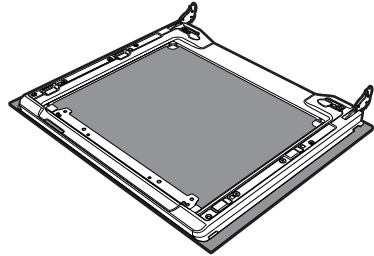

5. Refit the panes in the reverse order in which they were removed.
6. Reposition the internal glass pane. Take care to centre and insert the 4 pins into their housings in the oven door by applying slight pressure.

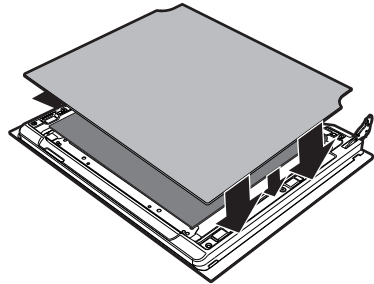



Cleaning and maintenance

4.4 Cleaning the oven cavity

In order to keep your oven in the best possible condition, clean it regularly after letting it cool down.

Avoid letting food residue dry inside the oven cavity, as this could damage the enamel.

Take out all removable parts before cleaning.

For easier cleaning, we recommend removing:

- The door
- The rack/tray support frames
- The oven seal.



In the event you are using specific cleaning products, we recommend running the oven at maximum temperature for 15-20 minutes in order to eliminate any residue.

Removing rack/tray support frames

Removing the guide frames enables the sides to be cleaned more easily. This operation should be performed each time the automatic cleaning cycle is used (on some models only).

To remove the guide frames, pull the frame towards the inside of the oven to unhook it from its groove **A**, then slide it out of the seats at the back **B**.

When cleaning is complete, repeat the above procedures to put the guide frames back in.

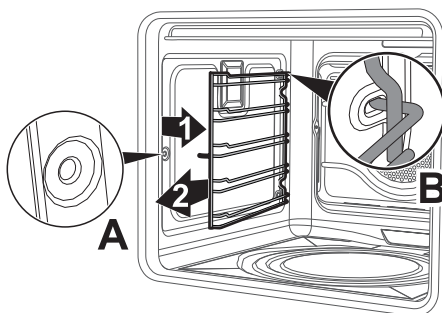



Cleaning the roof of the oven (not on pyrolytic models)



High temperature inside the oven during use
Danger of burns

- The following operations must be performed only with the oven switched off and completely cool.

The appliance is equipped with a tilting grill element that allows for easy cleaning of the upper part of the oven cavity.

1. Free the upper heating element by gently lifting it and rotating its retaining latch by 90 degrees.

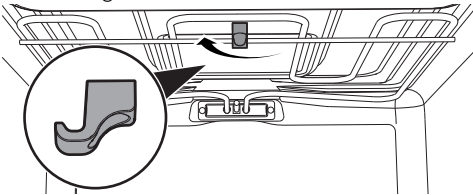

2. Gently lower the heating element until it stops.

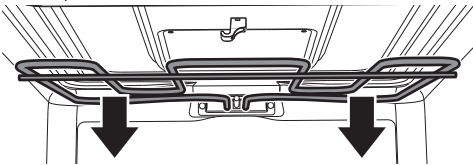

Improper use
Risk of damage to the appliance

- Do not excessively flex the element during cleaning.

3. When you have finished cleaning, place the heating element back in position and turn the retaining latch to lock it in place.

Cleaning the bottom of the oven (on some models only)

1. Remove in sequence the pizza stone cover (1) and the base (2) on which it is placed. The base has to be lifted a few millimetres, then pulled outwards.

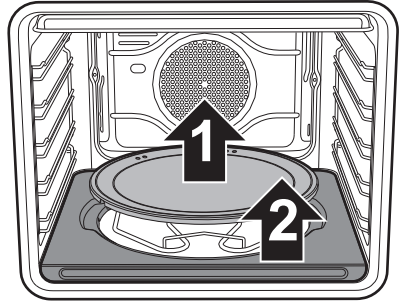

2. Lift the end of the bottom heating element (3) a few centimetres and clean the oven base.

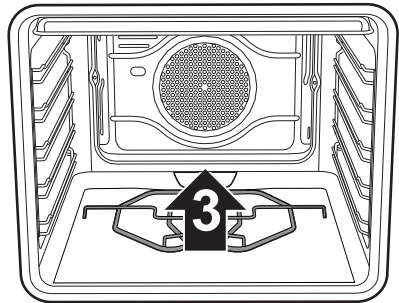

3. Put the pizza stone base back in place, pushing it in until it hits the back of the oven, and push it down so that the heating element plate is embedded into the base itself.



Cleaning and maintenance

Cleaning the pizza stone (on some models only)

The pizza stone should be washed separately according to the following instructions:

The stone must be cleaned after every use. Do not heat it again if it has any encrustations. To clean, pour 50 cc of vinegar onto the stone, leave it to act for 10 minutes, then remove it by wiping with a metallic mesh or abrasive sponge. Rinse with water then leave to dry.

- Before cleaning, remove any dirt burnt onto the stone with the aid of a metal spatula or a scraper of the kind used for cleaning glass ceramic hobs.
- For best results, the stone must still be warm; otherwise, wash it in hot water.
- Use metal mesh sponges or abrasive scotch-brite pads, dipped in lemon or vinegar.
- Never use detergents.
- Never wash in the dishwasher.
- Never leave the stone to soak.
- The damp stone must not be used for a least 8 hours after the end of the cleaning procedures.
- Over time, slight cracks may appear on the surface of the stone. This is due to the normal expansion caused by high temperatures of the enamel coating the stone.

4.5 Vapor Clean (on some models only)



Vapor Clean is an assisted cleaning procedure which facilitates the removal of dirt. Thanks to this process, it is possible to clean the inside of the oven very easily. The dirt residues are softened by the heat and water vapour for easier removal afterwards.



Improper use Risk of damage to surfaces

- Remove any food residues or large spills from previous cooking operations from the inside of the oven.
- Carry out assisted oven cleaning operations only when the oven is cold.

Preliminary operations

Before starting the Vapor Clean cycle:

- **For Multifunction models:** Completely remove all accessories from inside the oven.
- Pour approx. 40 cc of water onto the floor of the oven. Make sure it does not overflow out of the cavity.

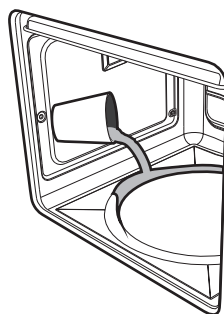

Cleaning and maintenance



- **For models with pizza stone:** Remove all accessories from the inside of the oven, except the rack/tray support frames.



The cover should be placed in the housing on the base of the oven in place of the pizza stone.

- Place a tray on the first shelf.
- Pour approximately 40 cc of water into the tray. Make sure it does not overflow out of the tray.

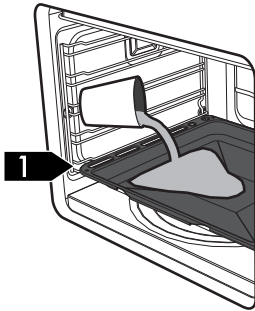

- **For Multifunction models and models with pizza stone:** Spray a water and washing up liquid solution inside the oven using a spray nozzle. Direct the spray against the side walls, upwards, downwards and towards the deflector.

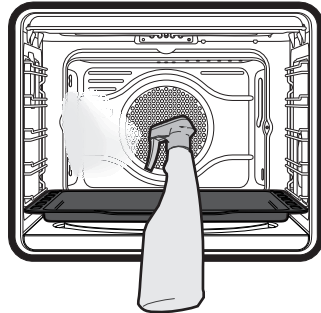
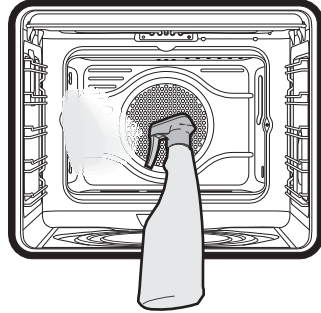

We recommend spraying approx. 20 times at the most.

- Close the door.
- During the assisted cleaning cycle, wash the self-cleaning panels (where fitted), which were previously removed, separately in warm water and a small amount of detergent.



Cleaning and maintenance

Vapor Clean cycle setting

i If the internal temperature is greater than that required for the Vapor Clean cycle, the cycle will be stopped immediately and the message **STOP** will appear on the display. Let the appliance cool down before activating the assisted cleaning cycle.

1. Press and turn the function knob to select the Vapor Clean function . The duration and temperature of the cleaning cycle will appear on the display.

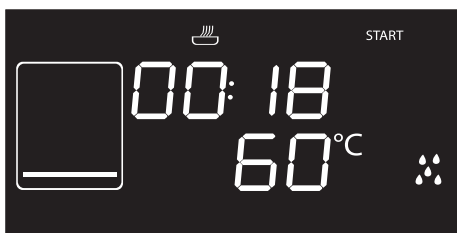

i The temperature and time parameters cannot be modified by the user.

2. Press the function knob to start the automatic cleaning cycle.

Programmed Vapor Clean cycle

Like for the normal cooking functions, it is also possible to set an end time for the Vapor Clean function.

1. After selecting the Vapor Clean function, press the temperature knob. The indicator light  starts flashing. The display shows the function end time.

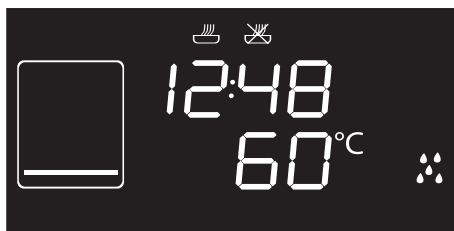

2. Turn the temperature knob right or left to delay the cooking end time.
3. Press the temperature knob to confirm the function end time.
4. Press the function knob. The appliance waits for the set start time.



End of the Vapor Clean cycle

When finished, **STOP** appears on the display and a buzzer will sound that can be deactivated by pressing the temperature knob.

1. Press and hold the function knob for at least 3 seconds to exit the function.
2. Open the door and wipe away the less stubborn dirt with a microfibre cloth.
3. Use a non-scratch sponge with brass filaments on hard to remove deposits.
4. In case of grease residues use specific oven cleaning products.
5. Remove the residual water inside the oven.

For improved hygiene and to avoid food being affected by any unpleasant odours, we recommend that the oven is dried using a fan-assisted function at 160°C for approximately 10 minutes.



We recommend wearing rubber gloves for these operations.



We recommend removing the door in order to make the manual cleaning of the parts that are difficult to reach easier.

4.6 Pyrolytic (on some models only)



Pyrolytic cleaning is an automatic, high-temperature cleaning procedure that causes dirt to dissolve. Thanks to this process, it is possible to clean the inside of the oven very easily.



Improper use Risk of damage to surfaces

- Remove any food residues or large spills from previous cooking operations from the inside of the oven.

Preliminary operations

Before starting the pyrolytic cycle:

- Clean the internal glass pane following the usual cleaning instructions.
- For very stubborn encrustations spray an oven cleaning product onto the glass (read the warnings on the product); leave for 60 minutes, then rinse and dry the glass using kitchen roll or a microfibre cloth.
- Completely remove all accessories from inside the oven.
- Remove the rack/tray support frames.
- Detach removable guides, where fitted.
- Close the door.



Cleaning and maintenance

Pyrolytic function setting

1. Select one of the cleaning functions **PYRO** or **PYRO ECO** with the function knob.
2. Turn the temperature knob to the right or to the left to set the cleaning cycle duration from a minimum of 2 hours to a maximum of 3 hours (except for the **PYRO ECO** function whose duration is 120 minutes).
3. Press the temperature knob to start the pyrolytic cycle.



Recommended pyrolytic cycle duration:

- Light dirt: 2 hours.
- Medium dirt: 2 ½ hours.
- Heavy dirt: 3 hours.

Pyrolytic cycle

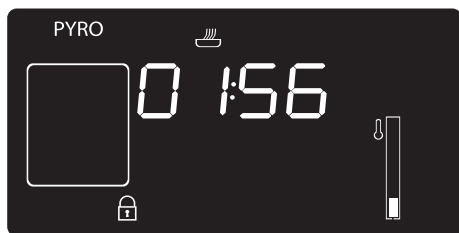

1. The display shows **PYRO** or **PYRO ECO** and the remaining time to indicate that the appliance is carrying out the automatic cleaning cycle.
2. Two minutes after the pyrolytic cycle has started the door is locked (the door lock indicator light  comes on) by a device that prevents the door from being opened.



It is not possible to select any function once the door lock device has been activated.

3. At the end of the pyrolytic cycle, the door remains locked as long as the temperature inside the oven cavity returns to safety levels. Wait for the oven to cool down and collect the residue deposited inside it using a damp microfibre cloth.



During the first pyrolytic cycle, unpleasant odours may occur due to the normal evaporation of oily manufacturing substances. This is an absolutely normal phenomenon which disappears after the first pyrolytic cycle.



During the pyrolytic cycle the fans produce a more intense level of noise due to a greater rotation speed. This is an absolutely normal operation, intended to provide more effective heat dispersal. At the end of the pyrolytic cycle, the fans will continue to operate for long enough to avoid overheating the walls of adjacent units and the front of the oven.





If the pyrolytic cycle gives unsatisfactory results at minimum duration, it is recommended to set a longer time for successive cleaning cycles.



Setting of programmed pyrolytic cycle

It is possible to program the pyrolytic cycle start time like all other cooking functions.

1. After selecting the pyrolytic cycle duration, press the temperature knob. The display shows the current time and the  indicator light comes on.
2. Turn the temperature knob to set the time at which you wish to complete the pyrolytic cycle.
3. After a few seconds, the  and  indicator lights remain on steadily and the appliance waits for the set start time to start the cleaning cycle.



It is not possible to select any function once the door lock device has been activated.

4.7 Extraordinary maintenance

Removing and installing the oven seal (not on pyrolytic models)

To remove the oven seal:

- Unhook the clips located in the 4 corners then pull the oven seal outwards.

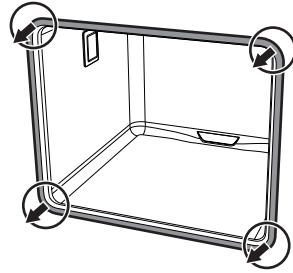

To install the oven seal:

- Hook the fasteners located in the 4 corners onto the oven seal.

Oven seal maintenance tips

The seal should be soft and elastic.

- To keep the oven seal clean, use a non-abrasive sponge and wash with lukewarm water.



Cleaning and maintenance

Replacing the internal light bulb



Live parts
Danger of electrocution

- Unplug the appliance.

1. Completely remove all accessories from inside the oven.
2. Remove the rack/tray support frames.
3. Remove the bulb cover using a tool (e.g. a screwdriver).



Pay attention not to scratch the oven cavity enamel.

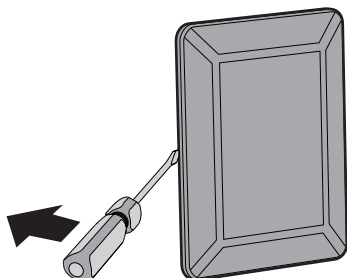

4. Slide out and remove the light bulb.

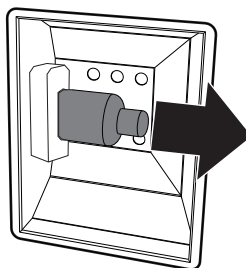

Do not touch the halogen light bulb directly with your fingers, but wrap it in insulating material.

5. Replace the light bulb with one of the same type (40W).
6. Refit the cover. Ensure the moulded part of the glass (**A**) is facing the door.

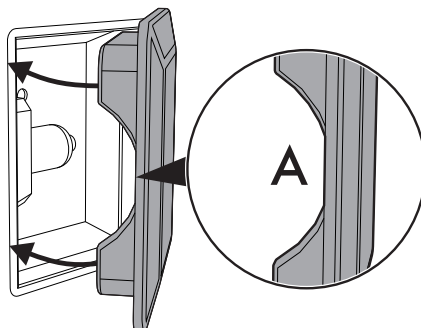

7. Press the cover completely down so that it attaches perfectly to the bulb support.



What to do if...

The display is completely off:

- Check the mains power supply.
- Check whether an omnipolar switch upstream of the appliance supply line is in the "ON" position.

The appliance does not heat up:

- Check whether it has been set to "showroom" mode (for further details see "Secondary menu").

The controls do not respond:

- Check whether "child lock" mode has been set (for further details see "Secondary menu").

The cooking times are longer than those indicated in the table:

- Check whether it has been set in "ecologic" mode (for further details see "Secondary menu").

After the (pyrolytic) automatic cleaning cycle it is not possible to select a function:

- Verify whether the door lock has deactivated. If it has not, the oven has a safety device that does not allow functions to be selected while the door lock is active. This is because the temperature inside the oven is still too high to permit any type of cooking.

The display shows "ERR4":

- The door lock has not properly attached to the door. This might be because the door was accidentally opened during the door lock activation. Switch the appliance off and on again, waiting a few minutes before selecting a new cleaning cycle.

If the door is opened during a fan assisted function, the fan stops:

- This is not a fault. It is a normal operation of the appliance, useful when cooking foods in order to avoid excessive heat escaping. When the door is closed, the oven will return to normal operation.



If the problem has not been resolved or in the case of other types of fault, contact your local technical support centre.



If other ERRx error messages are indicated:

Note down the error message, function and set temperature and contact your local technical support centre.



Installation

5 Installation

5.1 Electrical connection



Power voltage
Danger of electrocution

- Have the electrical connection performed by authorised technical personnel.
- The appliance must be connected to earth in compliance with electrical system safety standards.
- Disconnect the mains power supply.

General information

Check the grid characteristics against the data indicated on the plate.

The identification plate bearing the technical data, serial number and brand name is visibly positioned on the appliance.

Do not remove this plate for any reason.

The appliance operates at 220-240 V~.

Use a three-core cable (3 x 1.5 mm² internal conductors).

Perform the ground connection using a wire that is 20 mm longer than the other wires.

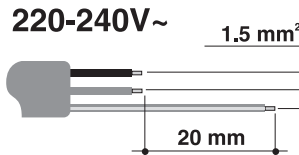

Fixed connection

Fit the power line with an omnipolar circuit breaker in compliance with installation regulations.

The circuit breaker should be located near the appliance and in an easily reachable position.

Connection with plug and socket

Make sure that the plug and socket are of the same type.

Avoid using adapters and shunts as these could cause overheating and a risk of burns.

5.2 Cable replacement



Power voltage
Danger of electrocution

- Disconnect the mains power supply.

1. Unscrew the rear casing screws and remove the casing to access the terminal board.

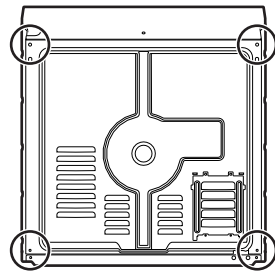

2. Replace the cable.
3. Make sure that the cables (for the oven or any hob) follow the best route in order to avoid any contact with the appliance.



5.3 Positioning



Heavy appliance
Crushing hazard

- Position the appliance into the cabinet cut-out with the help of a second person.



Pressure on the open door
Risk of damage to the appliance

- Never use the oven door to lever the appliance into place when fitting.
- Avoid exerting too much pressure on the oven door when open.



Heat production during appliance operation
Risk of fire

- Check that the carcass material is heat resistant.
- Check that the carcass has the required openings.
- Do not install the appliance in a recess which can be closed with a door, or in a cupboard.

Position of the power cable

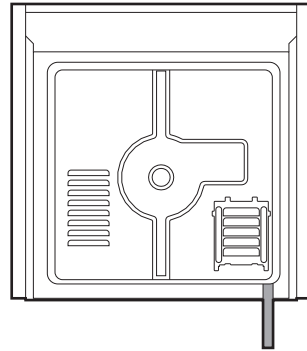

(rear view)

Front panel seal

Glue the supplied seal to the rear part of the front panel to avoid water or other liquids from leaking in.

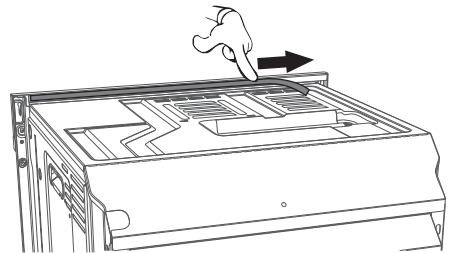



Installation

Fastening bushings

1. Remove the bushing covers on the front of the appliance.

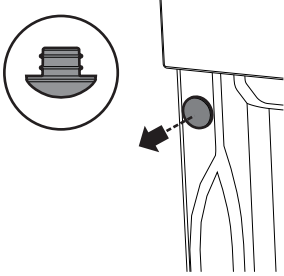

2. Mount the appliance into the recess.
3. Secure the appliance to the carcass using the screws.

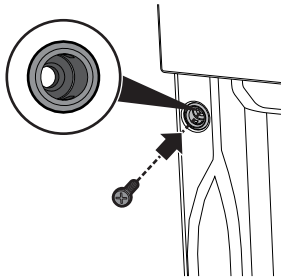

4. Cover the bushings with the previously removed covers.

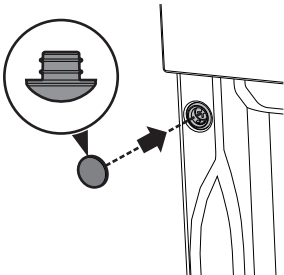

Appliance overall dimensions (mm)

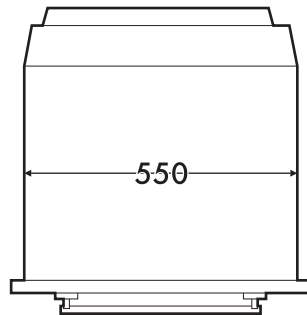
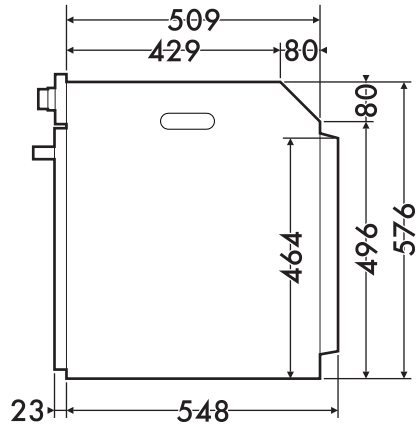
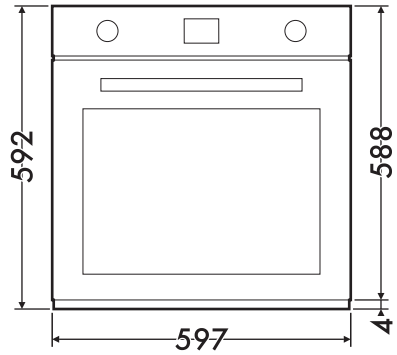

Installation



Mounting under worktops (mm)

EN

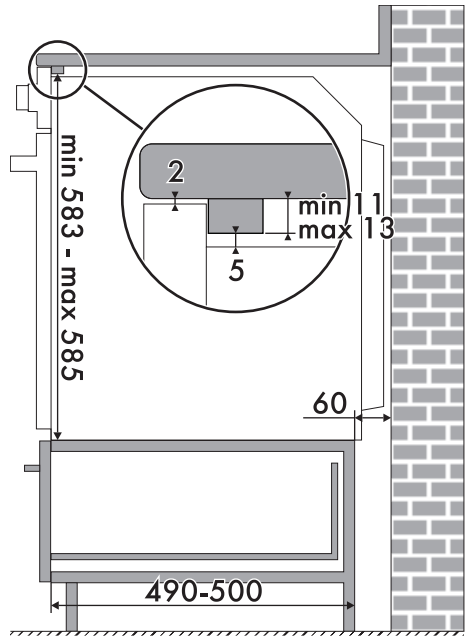
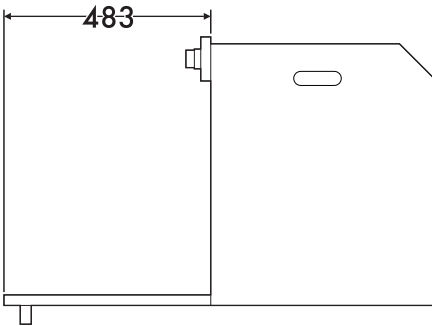
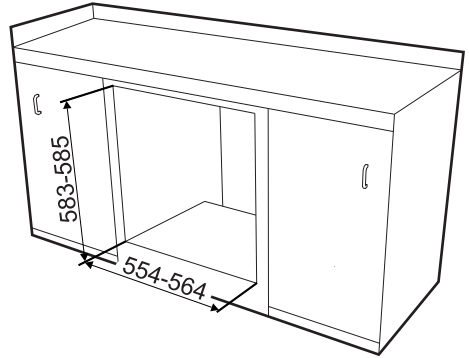
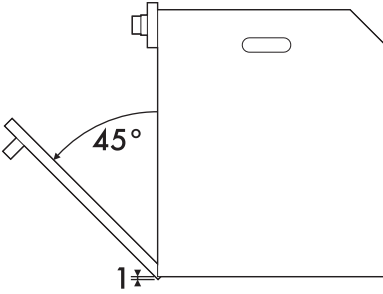

Make sure that the carcass rear/
bottom section has an opening of
approx. 60 mm.



Installation

Mounting into a column (mm)

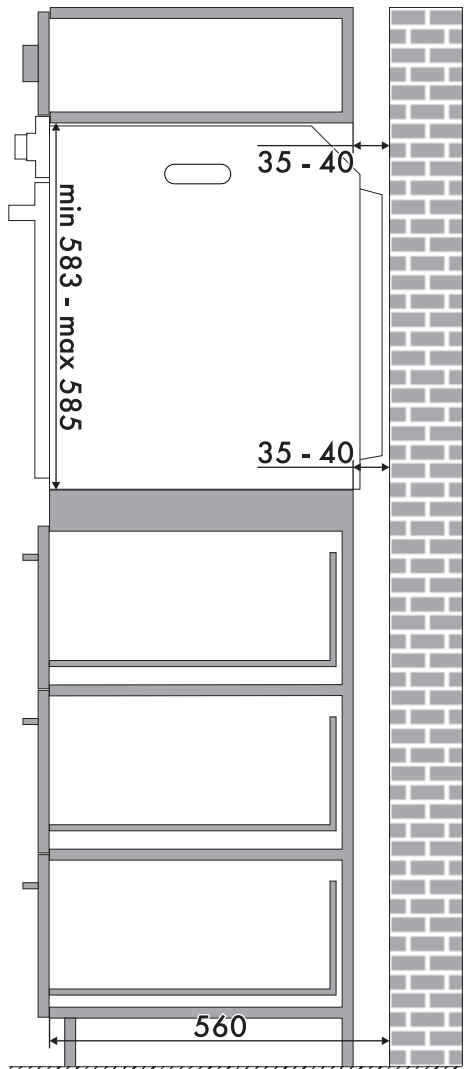
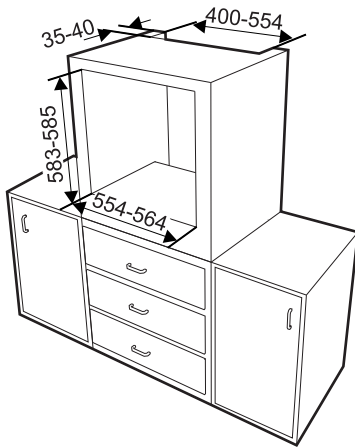

Make sure that the carcass top/rear section has an opening approx. 35-40 mm deep.