

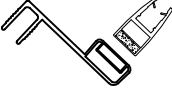



















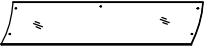

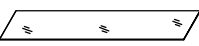
A		2	J		1	S		2
B	 ST4X16	8	K	 ST4X10	2	T		4
C		8	L		2	U	 ST4X6	4
D	 ST4X30	8	M	 ST4X10	2	V		1
E		1	N		1	W	 ST4X10	4
F		1	O		1	X		1
G		4	P		1			
H		2	Q		1			
I		2	R		2			



Ø6, Ø2.8



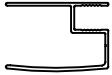
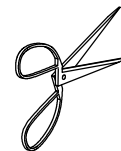
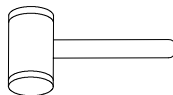
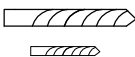
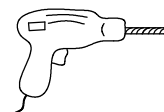
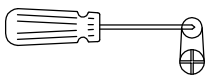
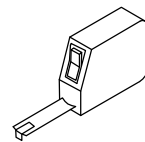
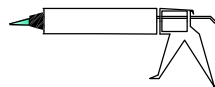
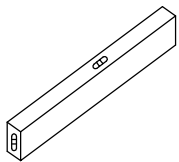
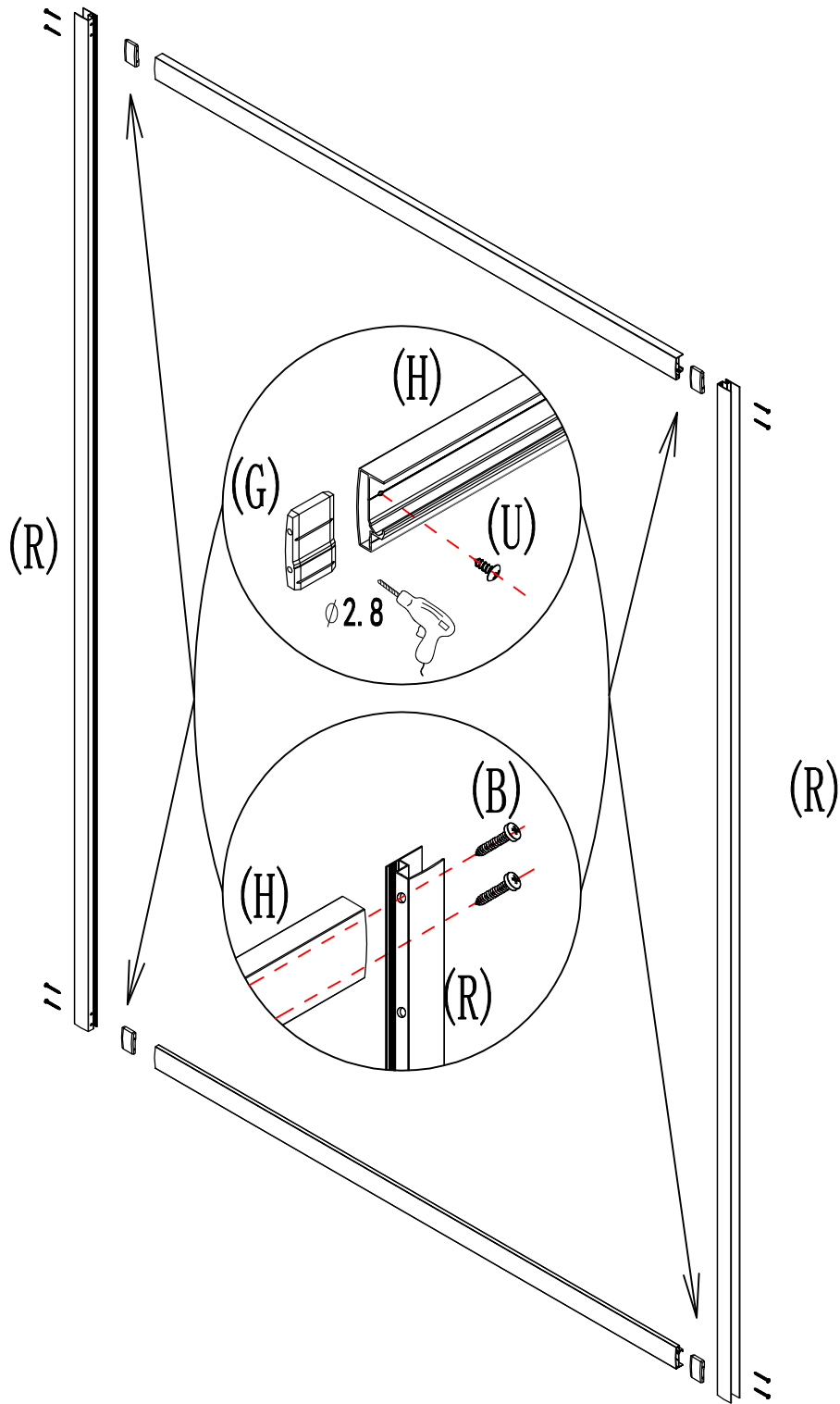
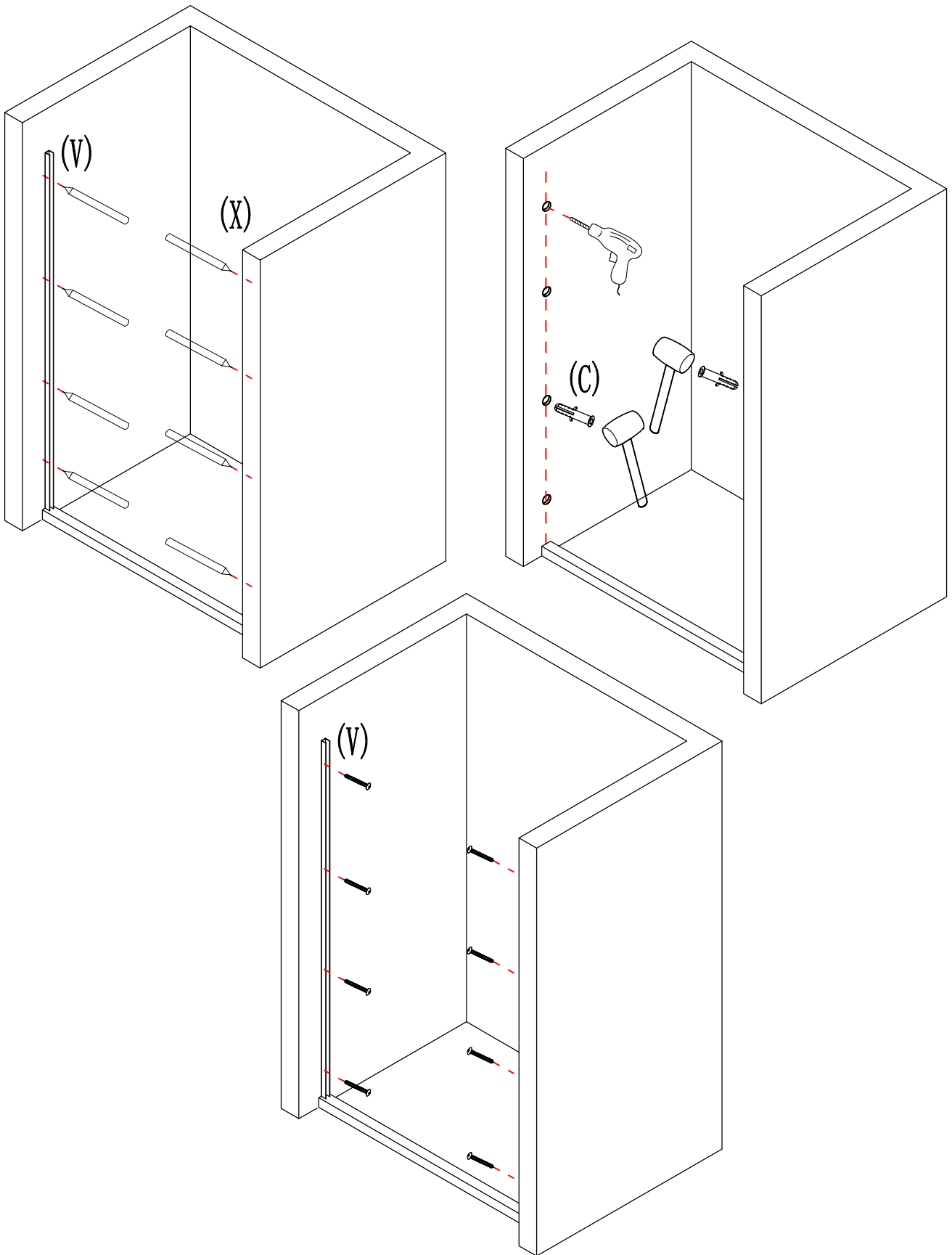

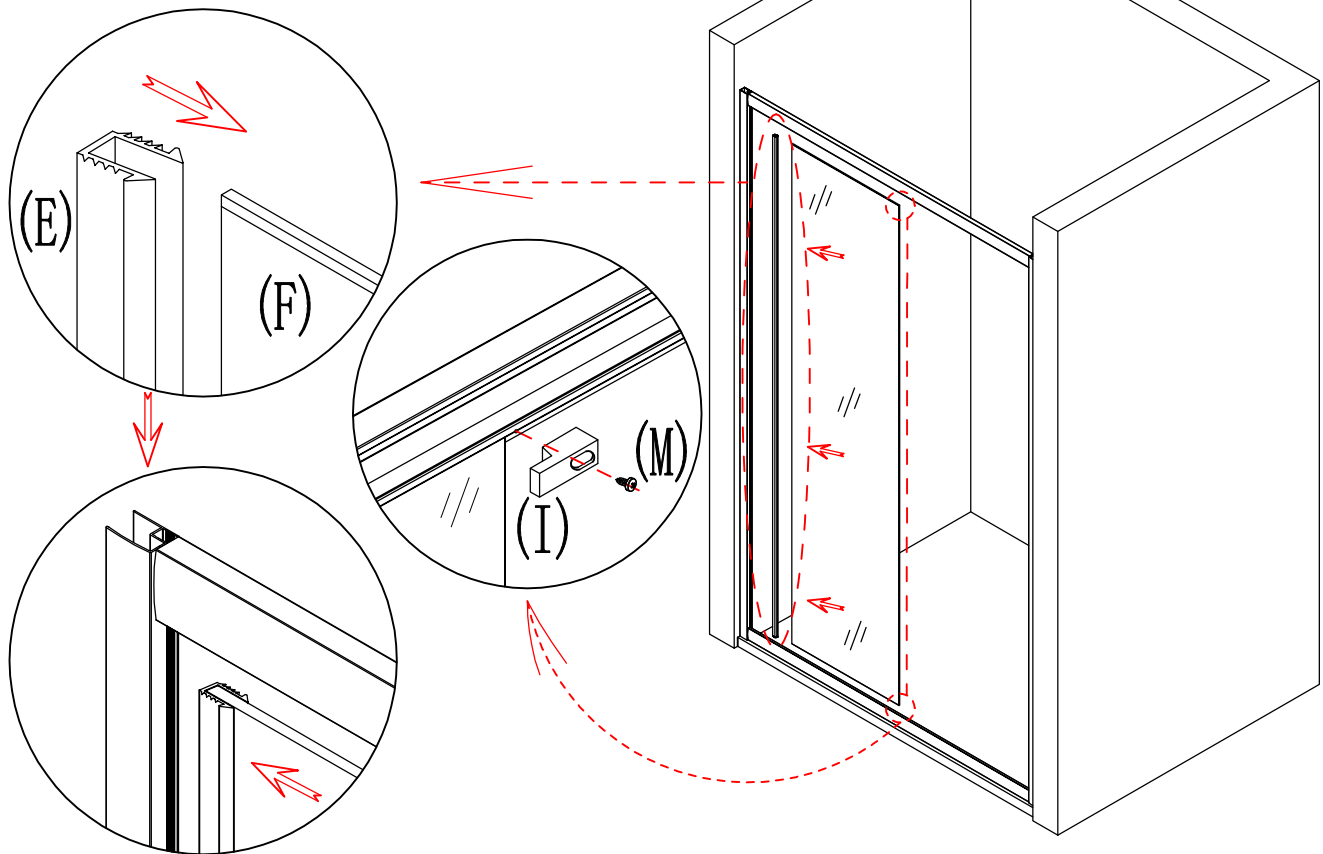
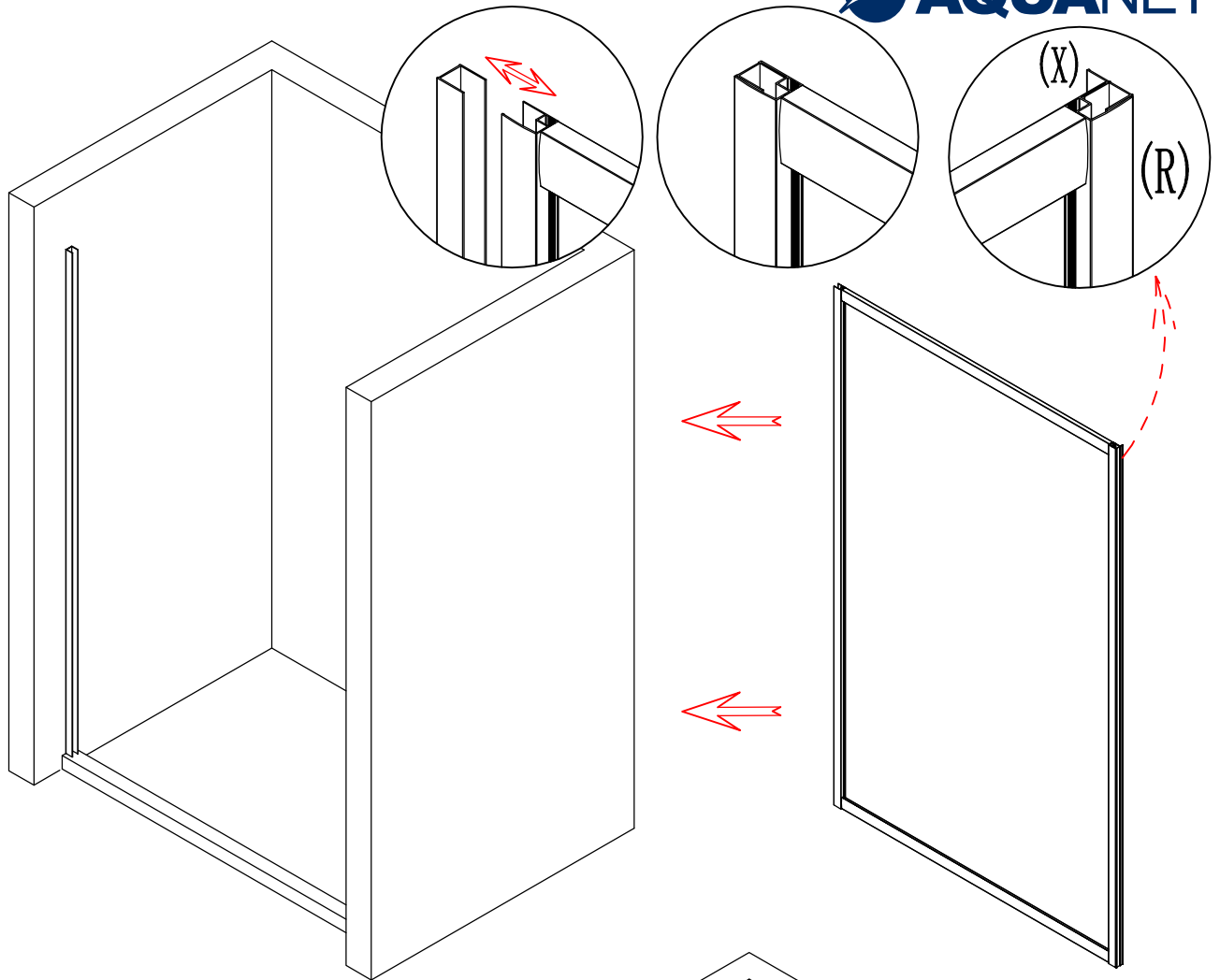

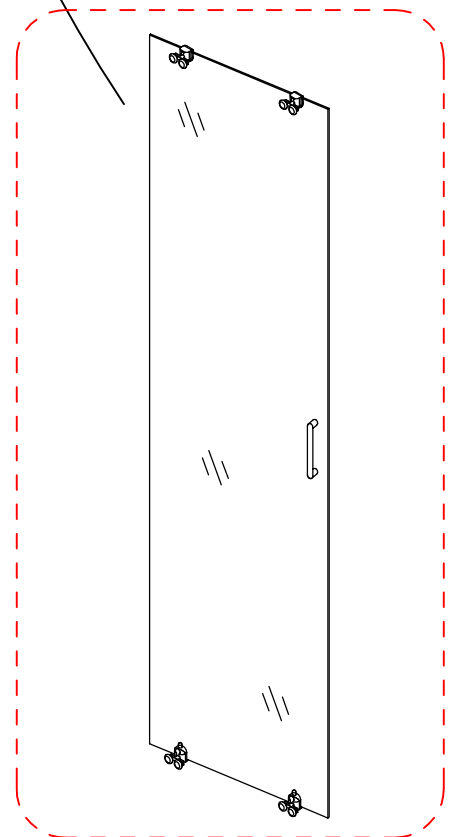
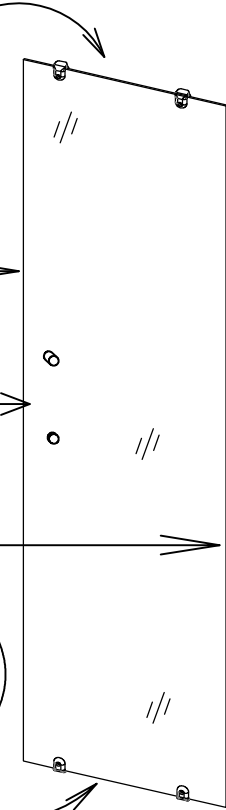
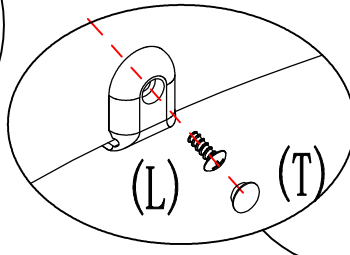
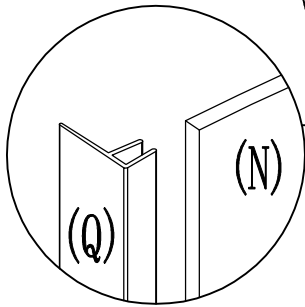
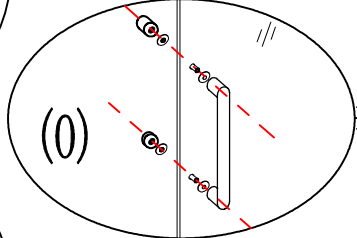
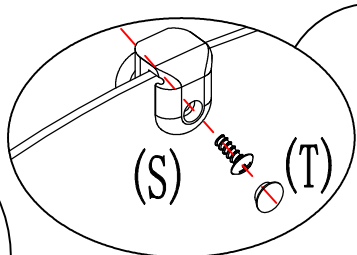
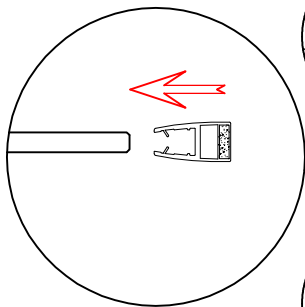
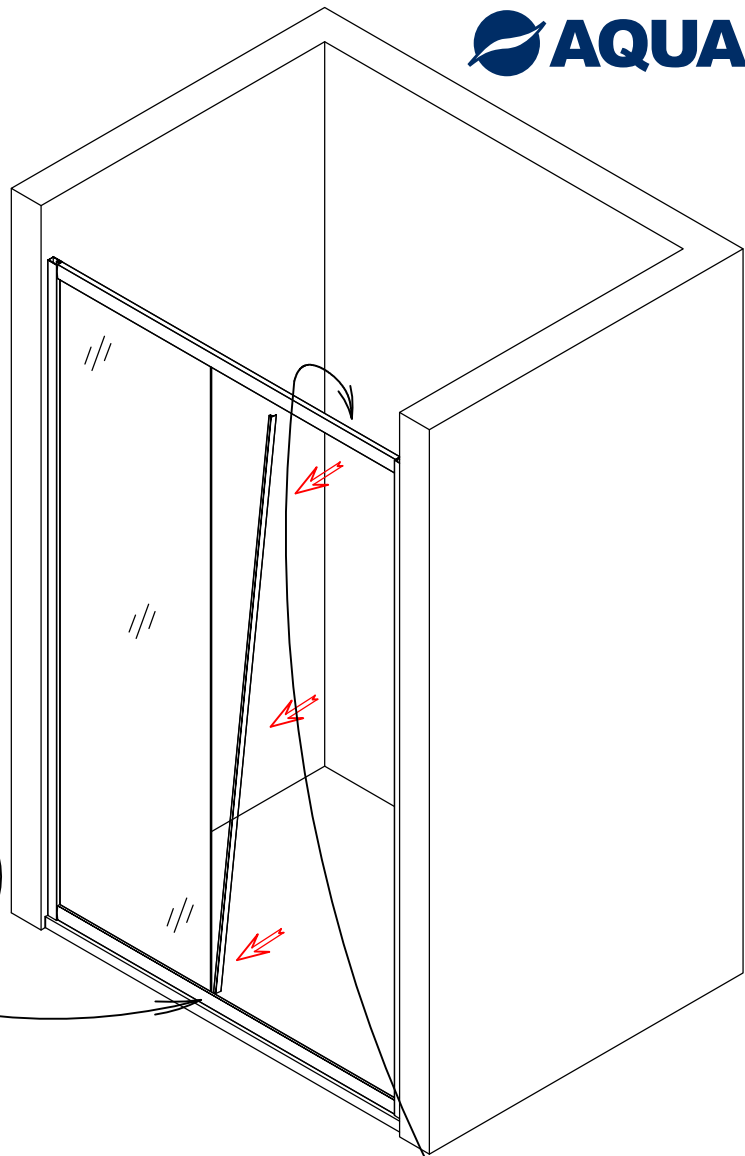
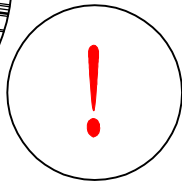
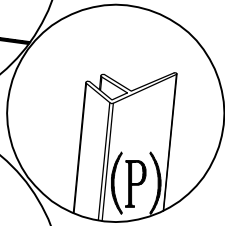
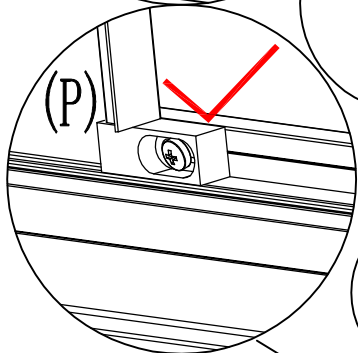
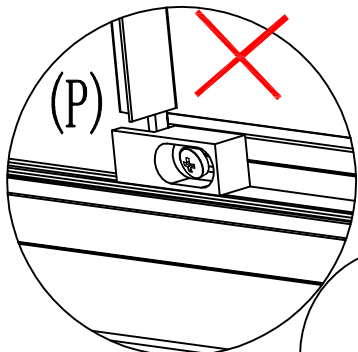

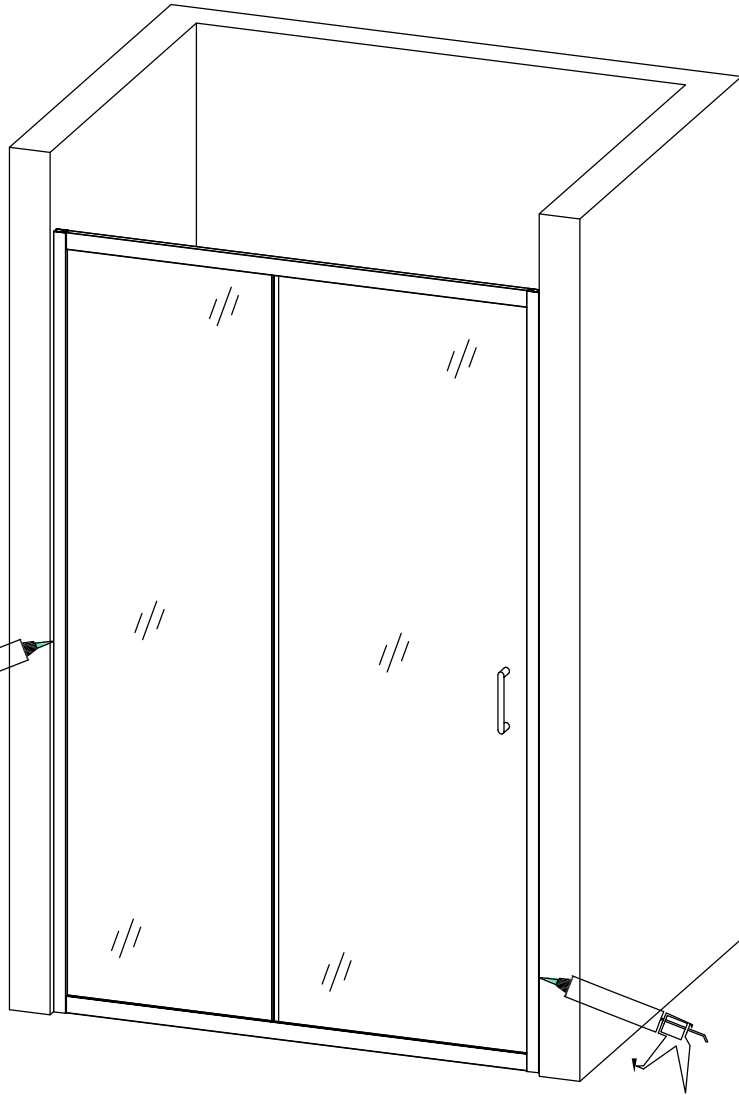
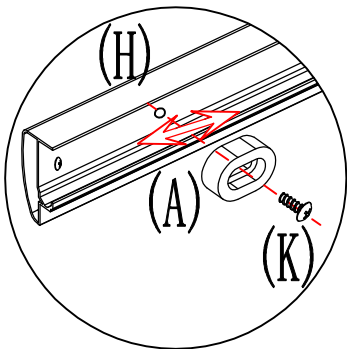
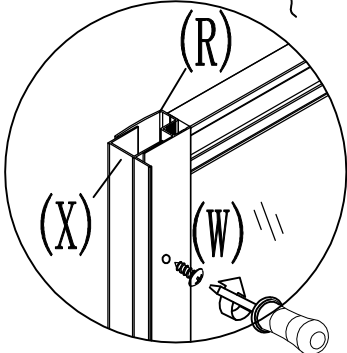
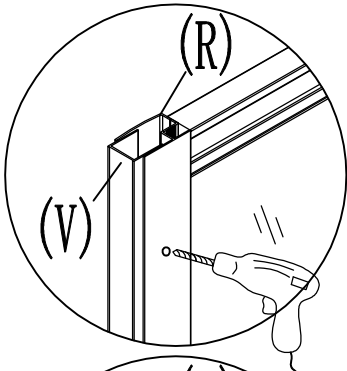
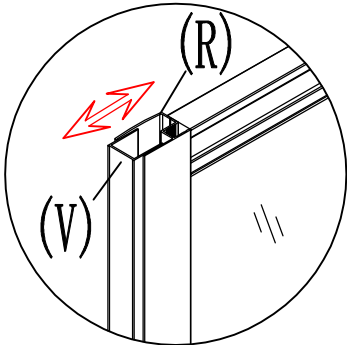
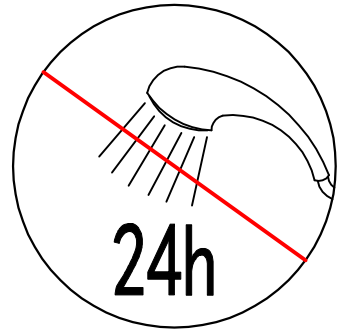
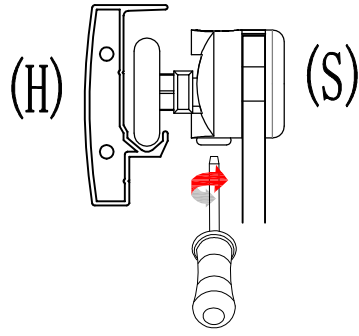





- |   |   |   |   |  |
|---|---|---|---|--|
|  |  |  |  |  |
| 4   | ST4X30 4  | ST4X10 2  | ST4X20 2  | 1  |

