

# Contents

<b>1</b>	<b>Instructions</b>	<b>66</b>
1.1	General safety instructions	66
1.2	Manufacturer liability	67
1.3	Appliance purpose	67
1.4	Disposal	67
1.5	Identification plate	68
1.6	This user manual	68
1.7	How to read the user manual	68
<b>2</b>	<b>Description</b>	<b>69</b>
2.1	General Description	69
2.2	Control panel	70
2.3	Other parts	70
2.4	Available accessories	71
<b>3</b>	<b>Use</b>	<b>72</b>
3.1	Instructions	72
3.2	First use	72
3.3	Using the accessories	73
3.4	Using the oven	73
3.5	Cooking advice	79
3.6	Special functions	84
3.7	Preset recipes	92
3.8	Personal programs	98
3.9	Settings	103
<b>4</b>	<b>Cleaning and maintenance</b>	<b>109</b>
4.1	Instructions	109
4.2	Cleaning the appliance	109
4.3	Removing the door	109
4.4	Cleaning the door glazing	110
4.5	Vapor Clean (on some models only)	112
4.6	Pyrolytic (on some models only)	115
4.7	Extraordinary maintenance	118
<b>5</b>	<b>Installation</b>	<b>121</b>
5.1	Electrical connection	121
5.2	Cable replacement	121
5.3	Positioning	122

We advise you to read this manual carefully, which contains all the instructions for maintaining the appliance's aesthetic and functional qualities.

For further information on the product: [www.smeg.com](http://www.smeg.com)



# Instructions

## 1 Instructions

### 1.1 General safety instructions

#### Risk of personal injury

- During use the appliance and its accessible parts become very hot.
- Never touch the heating elements during use.
- Keep children under the age of eight at a safe distance unless they are constantly supervised.
- Children must not play with the appliance.
- Never rest metallic objects such as knives, forks, spoons and lids on the appliance during use.
- Switch off the appliance immediately after use.
- Never try to put out a fire or flames with water: Turn off the appliance and smother the flames with a fire blanket or other appropriate cover.
- Cleaning and maintenance must not be carried out by unsupervised children.
- Have qualified personnel carry out installation and assistance interventions according to the standards in force.
- Do not modify this appliance.

- Do not insert pointed metal objects (cutlery or utensils) into the slots in the appliance.
- Do not try to repair the appliance yourself or without the intervention of a qualified technician.
- If the power supply cable is damaged, contact technical support immediately and they will replace it.

#### Risk of damaging the appliance

- Do not use abrasive or corrosive detergents (e.g. scouring powders, stain removers and metallic sponges) on glass parts.
- Use wooden or plastic utensils.
- Do not seat on the appliance.
- Do not use steam jets to clean the appliance.
- Do not obstruct ventilation openings and heat dispersal slots.
- Never leave the appliance unattended during cooking operations where fats or oils could be released.
- Never leave objects on the cooking surface.
- Do not use the appliance to heat rooms for any reason.



## For this appliance

- Ensure that the appliance is switched off before replacing the bulb.
- Do not rest any weight or sit on the open door of the appliance.
- Take care that no objects are stuck in the doors.

## 1.2 Manufacturer liability

The manufacturer declines all liability for damage to persons or property caused by:

- Use of the appliance other than that specified;
- Failure to comply with the instructions in the user manual;
- Tampering with any part of the appliance;
- The use of non-original spare parts.

## 1.3 Appliance purpose

- This appliance is intended for cooking food in the home environment. Every other use is considered improper.
- This appliance may be used by children aged at least 8 and by people of reduced physical, sensory or mental capacity, or lacking in experience in the use of electrical appliances, provided that they are supervised or instructed by adults who are responsible for their safety.
- The appliance is not designed to operate with external timers or with remote-control systems.

## 1.4 Disposal



This appliance must be disposed of separately from other waste (Directives 2002/95/EC, 2002/96/EC, 2003/108/EC). The appliance does not contain substances in quantities sufficient to be considered hazardous to health and the environment, in accordance with current European directives.

To dispose of the appliance:

- Cut the power supply cable and remove it along with the plug.



**Power voltage**

**Danger of electrocution**

- Disconnect the mains power supply.
- Unplug the appliance.
- Deliver the appliance to the appropriate recycling centre for electrical and electronic equipment waste, or return it to the retailer when purchasing an equivalent product, on a one for one basis.



# Instructions

Our appliances are packaged in non-polluting and recyclable materials.

- Deliver the packing materials to the appropriate recycling centre.



## Plastic packaging Danger of suffocation

- Do not leave the packaging or any part of it unattended.
- Do not let children play with the plastic bags.

## 1.5 Identification plate

The identification plate bears the technical data, serial number and brand name of the appliance. Do not remove the identification plate for any reason.

## 1.6 This user manual

This user manual is an integral part of the appliance and must therefore be kept in its entirety and within the user's reach for the whole working life of the appliance.

Read this user manual carefully before using the appliance.

## 1.7 How to read the user manual

This user manual uses the following reading conventions:

### Instructions



General information on this user manual, on safety and final disposal.

### Description



Description of the appliance and its accessories.

### Use



Information on the use of the appliance and its accessories, cooking advice.

### Cleaning and maintenance



Information for proper cleaning and maintenance of the appliance.

### Installation



Information for the qualified technician: Installation, operation and inspection.



Safety instructions



Information



Advice

1. Sequence of instructions for use.

- Standalone instruction.



## 2 Description

### 2.1 General Description

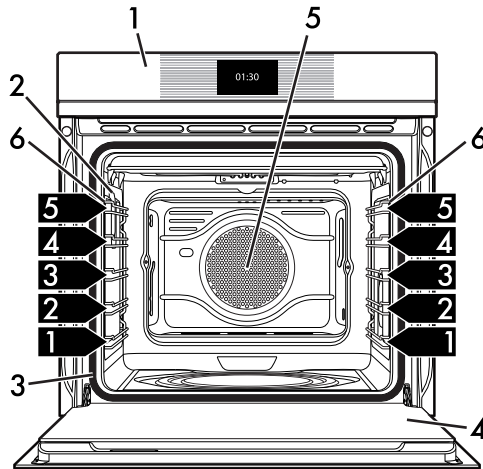

1 Control panel

2 Oven light

3 Seal

4 Door

5 Fan

6 Rack/tray support frames

**1,2,3...** Frame shelf



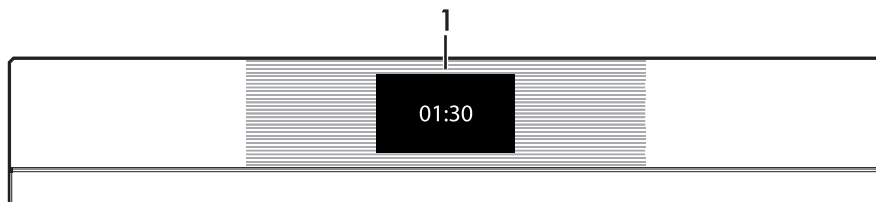

# Description

## 2.2 Control panel



### 1 Display

The touchscreen display allows you to interact with the appliance. Press the icons to access the various available functions. The display will show all operational parameters, such as: selected function, time/temperature settings or pre-set cooking program settings.

In general, press the symbol  to return to the previous menu or end a function; press the symbol  to confirm the selected options.

## 2.3 Other parts

### Shelves

The appliance features shelves for positioning trays and racks at different heights. The insertion heights are indicated from the bottom upwards (see 2.1 General Description).

### Cooling fan

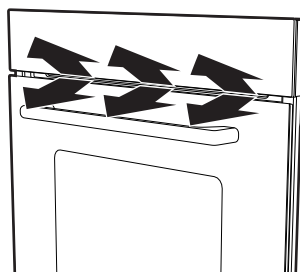





The fan cools the oven and comes into operation during cooking.

The fan causes a steady outflow of air from above the door which may continue for a brief period of time even after the appliance has been turned off.

### Interior lighting

The appliance interior lighting comes on:

- When the door is opened
- When any function is selected, apart from the ,  and  functions
- Press the symbol  to manually activate the oven light or the symbol  to deactivate it during use.



## 2.4 Available accessories



Some models are not provided with all accessories.

### Rack

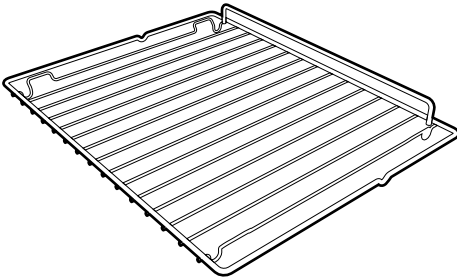

Useful for supporting containers with food during cooking.

### Tray rack

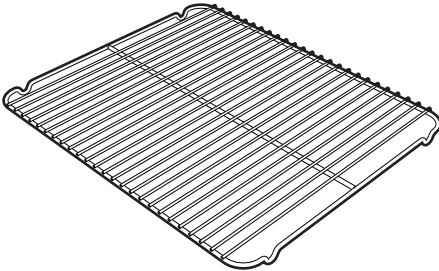

To be placed over the top of the oven tray; for cooking foods which may drip.

### Oven tray

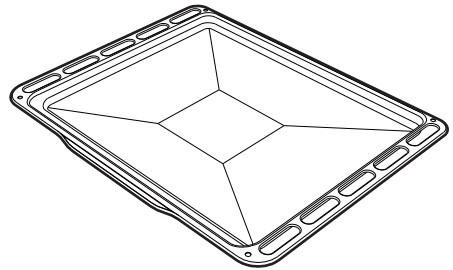

Useful for collecting fat from foods placed on the rack above.

### Deep tray

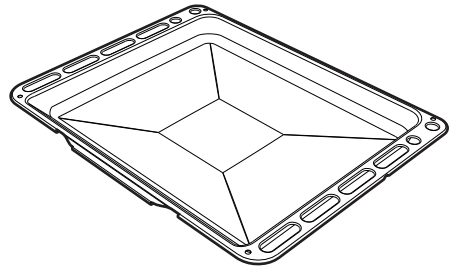

Useful for collecting fat from foods placed on the rack above and for cooking pies, pizzas, baked desserts, biscuits, etc.



The oven accessories intended to come into contact with food are made of materials that comply with the provisions of current legislation.



Supplied original and optional accessories can be requested to Authorised Assistance Centres. Use only original accessories supplied by the manufacturer.



## 3 Use

### 3.1 Instructions



**High temperature inside the oven during use**

**Danger of burns**

- Keep the oven door closed during cooking.
- Protect your hands wearing heat resistant gloves when moving food inside the oven.
- Do not touch the heating elements inside the oven.
- Do not pour water directly onto very hot trays.
- Do not allow children to get near the oven when it is in operation.



**High temperature inside the oven during use**

**Danger of fire or explosion**

- Do not spray any spray products near the oven.
- Do not use or leave flammable materials near the oven.
- Do not use plastic kitchenware or containers when cooking food.
- Do not put sealed tins or containers in the oven.
- Do not leave the oven unattended during cooking operations where fats or oils could be released.
- Remove all trays and racks which are not required during cooking.



**Improper use**

**Risk of damage to enamelled surfaces**

- Do not cover the bottom of the oven cavity with aluminium or tin foil sheets.
- If you wish to use greaseproof paper, place it so that it will not interfere with the hot air circulation inside the oven.
- Do not place pans or trays directly on the bottom of the oven cavity.
- Do not pour water directly onto very hot trays.

### 3.2 First use

1. Remove any protective film from the outside or inside of the appliance, including accessories.
2. Remove any labels (apart from the technical data plate) from the accessories and from the oven cavity.
3. Remove and wash all the appliance accessories (see 4 Cleaning and maintenance).
4. Heat the empty oven at the maximum temperature to burn off any residues left by the manufacturing process.





### 3.3 Using the accessories

#### Racks and trays

Racks and trays have to be inserted into the side guides until they come to a complete stop.

- The mechanical safety locks that prevent the rack from being taken out accidentally have to face downwards and towards the oven back.

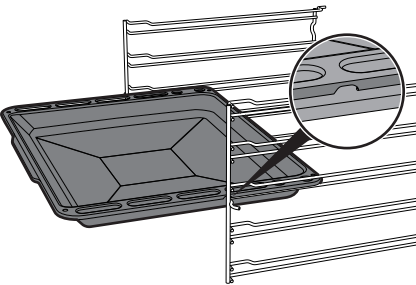
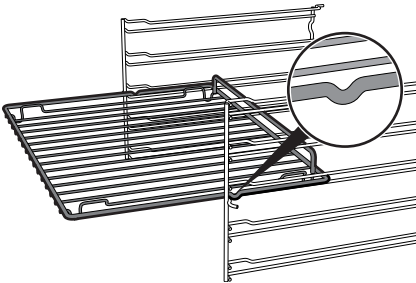

Gently insert racks and trays into the oven until they come to a stop.



Clean the trays before using them for the first time to remove any residues left by the manufacturing process.

#### Tray rack

The tray rack has to be inserted into the tray. In this way fat can be collected separately from the food which is being cooked.

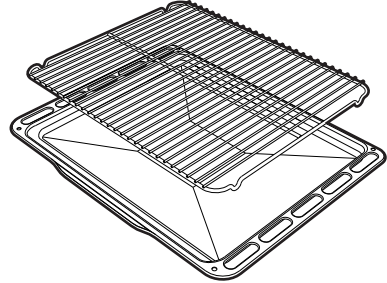

### 3.4 Using the oven

#### First use

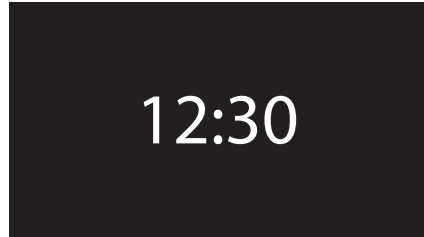

On the first use, or after a power failure, **00:00** will be flashing on the appliance's display. In order to be able to start any cooking program, the current time must be set (if the oven is being turned on for the first time, it is also recommended you set the required language).

Touch the display to enter the settings menu.



On first use, the appliance language is set to "English" by default.



# Use



When first connecting or after the power has been cut for a time it will be necessary to wait a few seconds before you can interact with the appliance.

## Home screen

Press the time on the display. It is now possible to select the various available functions on the home screen of the appliance.



- 1 Settings
- 2 Preset recipes
- 3 Cooking functions
- 4 Special functions
- 5 Personal programs

## Memory

Press the text  on the "home screen" to display the last preset recipes or personal recipes used

(in the example, the recipe **recipe 1** has been stored, see "Adding a recipe").

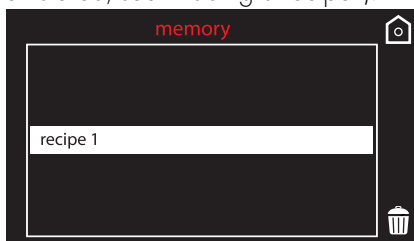

## Deleting the memory

If you wish to delete the memory:

1. Press the text  on the "home screen" to display the last preset recipes or personal recipes used.
2. Press the symbol .

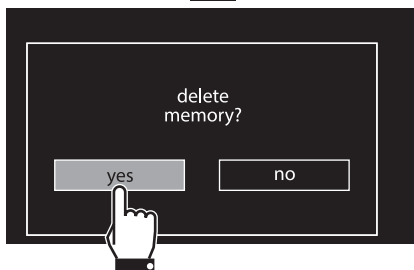

3. Select **yes** if you wish to delete the memory.

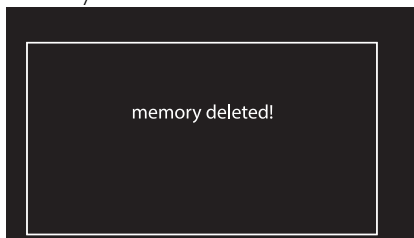



## Cooking functions

1. Select the **cooking functions**  icon on the "home screen".



2. Select the required function.

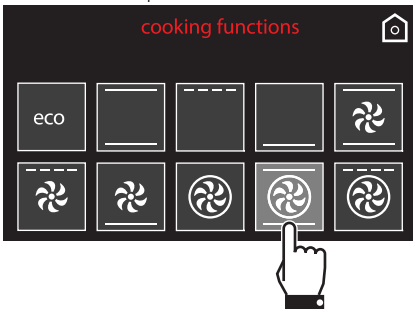

3. The appliance will begin preheating. The display will show the chosen function, the pre-set temperature, the current time and the progress bar of the temperature reached (preheating).



4. When the preheating stage is over a buzzer will sound to indicate that the food can be placed inside the oven.

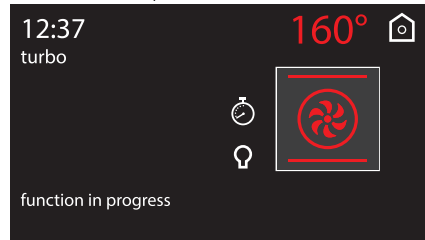

It is not recommended to place the dish in the oven during the automatic pre-heat stage.

## Interrupting a function

Press the return symbol  for approximately 2 seconds to interrupt a cooking function. Select the required option.

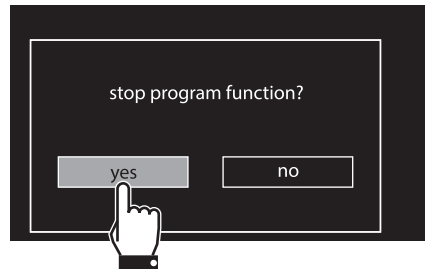

Press and hold the return symbol  for a few seconds to immediately interrupt cooking at any time and return to the main menu.



## Changing a function during cooking

1. Press the function symbol to modify it.

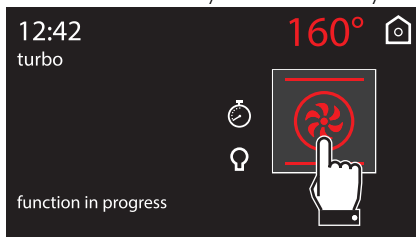

2. Press the symbol of the new function required.



3. The display will show the new function chosen, the preset temperature, the current time and the progress in reaching the new temperature.

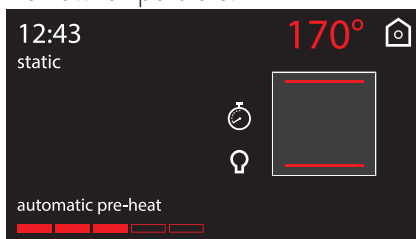

To avoid accidentally exiting the current function or screen displayed, the symbol  must be pressed and held down for longer than usual. Pressing and holding the symbol for 3 seconds always exits the current screen and function.

## Modifying the preset temperature

1. Press the displayed temperature to change it.



2. Use the symbols  and  to set the required temperature.

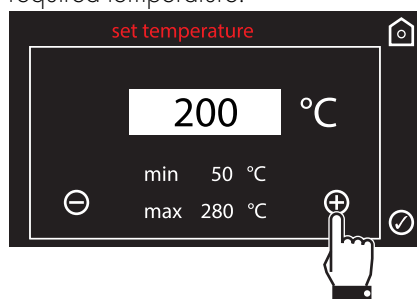



3. Press the symbol  to confirm.

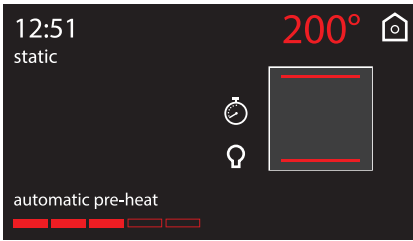

## List of cooking functions

### Eco

ECO

This function is particularly suitable for cooking on a single shelf with low energy consumption.

Ideal for cooking meat, fish and vegetables. It is not recommended for leavened foods.

To obtain maximum energy savings and reduce cooking times, it is recommended to place food in the oven without preheating.



When using the ECO function, avoid opening the door during cooking.



Cooking (and preheating) times are longer with the ECO function.

### Static

As the heat comes from above and below at the same time, this system is particularly suitable for certain types of food. Traditional cooking, also known as static cooking, is suitable for cooking just one dish at a time. Perfect for all types of roasts, bread and cakes, and in any case, particularly suitable for fatty meats such as goose and duck.

### Grill

The heat coming from the grill element gives perfect grilling results above all for thin and medium thickness meat and, in combination with the rotisserie (where fitted), gives the food an even browning at the end of cooking. Perfect for sausages, spare ribs and bacon. This function enables large quantities of food, particularly meat, to be grilled evenly.

### Lower element

The heat coming just from the bottom allows you to complete the cooking of foods that require a higher bottom temperature, without affecting their browning. Perfect for cakes, pies, tarts and pizzas.



## Fan assisted

The operation of the fan, combined with traditional cooking, ensures consistent cooking even with complex recipes. Perfect for biscuits and cakes, even when simultaneously cooked on several levels. (For multiple-level cooking, we recommend using the 1<sup>st</sup> and 4<sup>th</sup> shelves).



## Fan with grill

The air produced by the fan softens the strong heatwave generated by the grill, grilling perfectly even very thick foods. Perfect for large cuts of meat (e.g. shin of pork).



## Fan + lower element

The combination of the fan with just the lower heating element allows cooking to be completed more rapidly. This system is recommended for sterilising or for finishing off the cooking of foods which are already well-cooked on the surface, but not inside, which therefore need a little more heat. Perfect for any type of food.



## Circulaire

The combination of the fan and the circulaire heating element (incorporated in the rear of the oven) allows you to cook different foods on several levels, as long as they need the same temperatures and type of cooking. Hot air circulation ensures instant and even distribution of heat. It will be possible, for instance, to cook fish, vegetables and biscuits simultaneously (on different levels) without odours and flavours mingling.



## Turbo

The combination of fan assisted cooking and traditional cooking allows different foods to be cooked on several levels extremely quickly and efficiently, without odours and flavours mingling. Perfect for large volumes that call for intense cooking. (For multiple-level cooking, we recommend using the 1<sup>st</sup> and 4<sup>th</sup> shelves).



## Circulaire + fan with grill

The combination of fan assisted cooking and traditional cooking allows you to cook different foods on several levels extremely quickly and efficiently, without odours and flavours mingling. Perfect for large volumes that call for intense cooking.



## 3.5 Cooking advice

### General advice

- Use a fan assisted function to achieve consistent cooking at several levels.
- It is not possible to shorten cooking times by increasing the temperature (the food could be overcooked on the outside and undercooked on the inside).
- To prevent condensation from forming on the glass, hot food should not be left inside the oven for too long after cooking.

### Advice for cooking meat

- Cooking times vary according to the thickness and quality of the food and to consumer taste.
- Use a meat thermometer when roasting meat, or simply press on the roast with a spoon. If it is hard, it is ready; If not, it needs another few minutes cooking.

### Advice for cooking with the Grill and the Fan with grill

- Meat can be grilled even when it is put into the cold oven or into the preheated oven if you wish to change the effect of the cooking.
- With the Fan with grill function, we recommend that you preheat the oven before grilling.
- We recommend placing the food at the centre of the rack.

### Advice for cooking desserts/pastries and biscuits

- Use dark metal moulds: They help to absorb the heat better.
- The temperature and the cooking time depend on the quality and consistency of the dough.
- To check whether the dessert is cooked right through: At the end of the cooking time, put a toothpick into the highest point of the dessert. If the dough does not stick to the toothpick, the dessert is cooked.
- If the dessert collapses when it comes out of the oven, on the next occasion reduce the set temperature by about 10°C, selecting a longer cooking time if necessary.

### Advice for defrosting and proving

- Place frozen foods without their packaging in a lidless container on the first shelf of the oven.
- Avoid overlapping the food.
- To defrost meat, use the rack placed on the second level and a tray on the first level. In this way, the liquid from the defrosting food drains away from the food.
- The most delicate parts can be covered with aluminium foil.
- For successful proving, a container of water should be placed in the bottom of the oven.



# Use

## To save energy

- Stop cooking a few minutes before the time normally used. Cooking will continue for the remaining minutes with the heat which has accumulated inside the oven.
- Reduce any opening of the door to a minimum to avoid heat dispersal.
- Keep the inside of the appliance clean at all times.
- (Where fitted) When it is not being used, remove the pizza plate and put the cover back in its slot.

## Timer during function



This function only activates the buzzer, without stopping cooking.

1. Press the symbol  during a cooking function.
2. Press on **timer**.

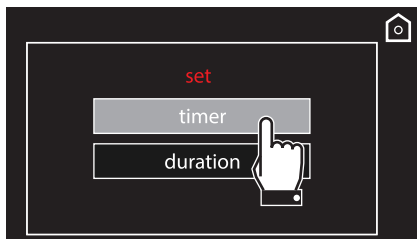

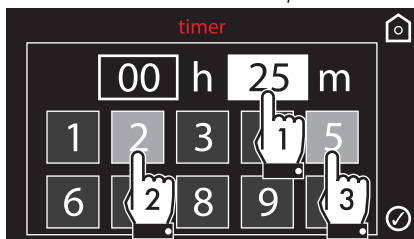

The duration of the timer can be from a minimum of 1 minute to a maximum of 4 hours.

3. Enter the required duration (for example 25 minutes: first touch the minutes box, then the numbers 2 and 5).



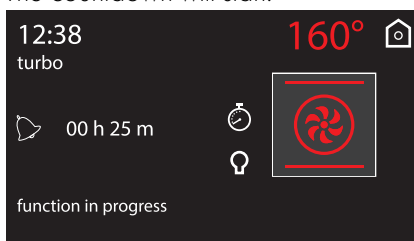

4. Press the symbol  to confirm.
5. The countdown will start.



6. Wait for the buzzer to indicate that the time has finished. The symbol  flashes.



Press the symbol  or  to deactivate the buzzer. Press the symbol  again to select another minute minder.





## Timed cooking

**i** Timed cooking is the function which allows a cooking operation to be started and then ended after a specific length of time set by the user.

**i** Activation of timed cooking cancels any minute minder timer which may previously have been set.

1. Press the symbol  during a cooking function.
2. Press on **duration**.

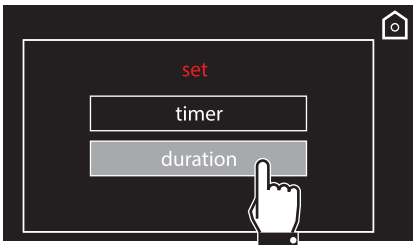

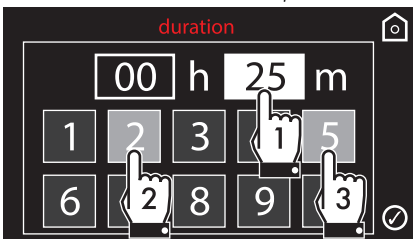

**i** The duration of the timer can be from a minimum of 1 minute to a maximum of 13 hours.

3. Enter the required duration (for example 25 minutes: first touch the minutes box, then the numbers 2 and 5).



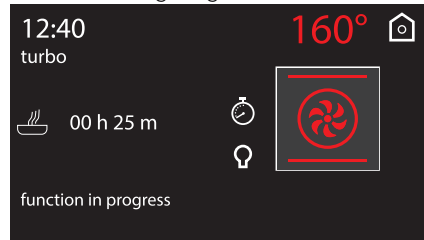

4. Press the symbol  to confirm.
5. Timed cooking begins.

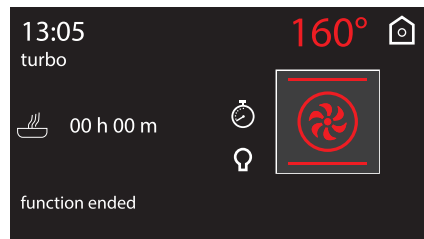

6. At the end of the cooking cycle, "function ended" appears on the display and a buzzer will sound that can be deactivated by pressing the symbols  or .



 To manually extend the cooking cycle, press the symbol  followed by the symbol . The appliance resumes its normal operation with the previously selected cooking settings.



## Modifying the data set during timed cooking

During operation, it is possible to modify timed cooking duration:

1. Press the symbol .
2. Press on **duration**.

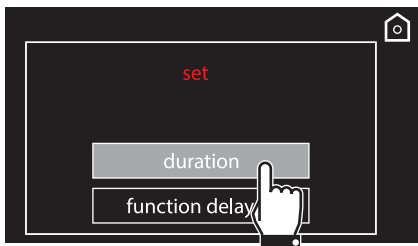

3. Enter the new duration required and press the symbol  to confirm.

## Delay cooking

**i** Delay cooking is the function which allows a cooking operation to be stopped at an established time depending on the time set by the user, after which the oven will switch off automatically.

1. After setting a cooking duration, press the symbol .
2. Press on **function delayed**.

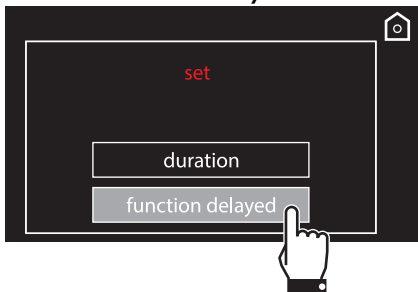

3. Enter the time at which you require cooking to end (for example at 7:30 p.m.: first touch the hours box, then the numbers 1 and 9; touch the minutes box, then the numbers 3 and 0).

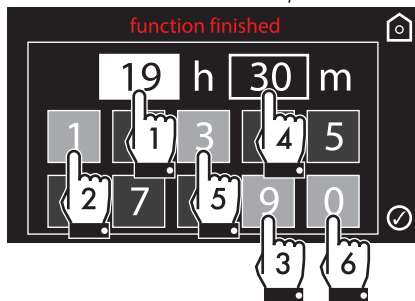

4. Press the symbol  to confirm.
5. The appliance waits for the delay start time.

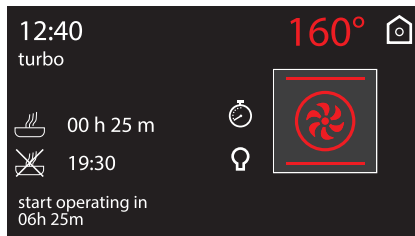

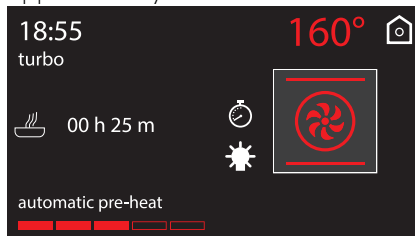

6. Based on the values set, the appliance will start a preheating stage of approximately 10 minutes.





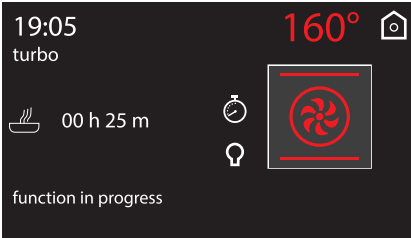

7. It will then proceed with the selected function.

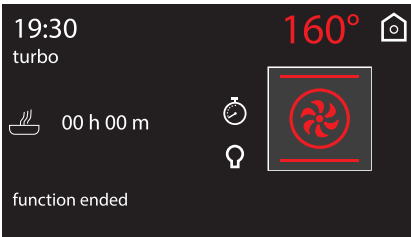

8. At the end of the cooking cycle, "function ended" appears on the display and a buzzer will sound that can be deactivated by pressing the symbols  or .



To manually extend the cooking cycle, press the symbol  followed by the symbol . The appliance resumes its normal operation with the previously selected cooking settings.



For safety reasons, it is not possible to set the cooking end time by itself without setting the cooking duration.



## Modifying the data set during programmed cooking





After modifying the cooking duration, the end of cooking time must be re-set.

EN

During operation, it is possible to modify programmed cooking duration:

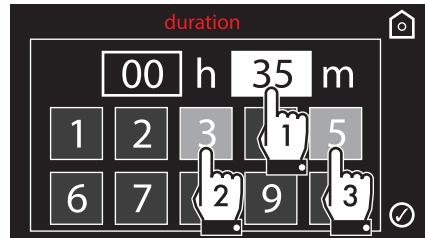
1. Press the symbol .
2. Enter the new duration required (for example 35 minutes) and press the symbol .



3. Press the symbol  again.
4. Enter the new cooking end time required (for example 7:00 p.m.) and press the symbol .

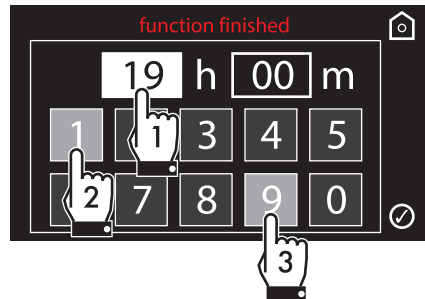



## 3.6 Special functions

The special functions menu contains some functions like the timer with the oven off, defrosting or cleaning functions.

Select the **special functions**  icon on the "home screen".



### Proving

The proving function, using the heat coming from the top, makes it possible to prove all types of dough, guaranteeing perfect results quickly.



### Food warming

To heat food or keep it hot.



### Sabbath

This function allows food to be cooked while respecting the requirements of the Jewish Sabbath.



### Vapor Clean (on some models only)

This function facilitates cleaning using the steam produced by a small quantity of water poured onto the appropriate drawing placed on the bottom.



Certain functions are not available on all models.

## List of special functions



### Timer

This function sounds a buzzer when the time set has elapsed.



### Defrost by weight

This function defrosts foods on the basis of the type and weight of the frozen product.



### Defrost by time

This function allows you to defrost food on the basis of a selectable time.



### ECO P ECO pyrolytic (on some models only)

When this function is set, the oven executes a pyrolytic cycle at 500°C for a pre-set time. For use in the case of ovens which are not too dirty.

### P Pyrolytic (on some models only)

Setting this function, the oven reaches temperatures up to 500°C, destroying all the grease which forms on the internal walls.

**i** The more complex special functions are illustrated below. For functions such as Vapor Clean, Pyrolytic and ECO Pyrolytic, see "4 Cleaning and maintenance".

## Timer

**i** The duration of the minute minder can be from a minimum of 1 minute to a maximum of 4 hours.

1. Select **timer** from the "special functions" menu.

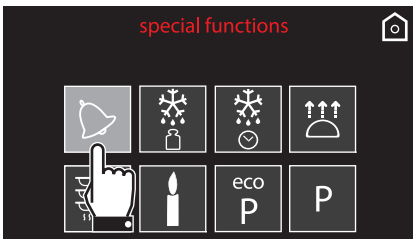



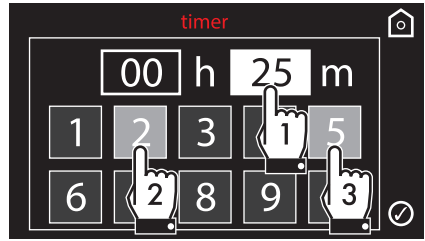

2. Enter the required duration (for example 25 minutes: first touch the minutes box, then the numbers 2 and 5).



3. Press the symbol  to confirm.
4. The countdown will start.



5. Wait for the buzzer to indicate that the time has finished. The symbol  flashes.

 Press the symbol  or  to deactivate the buzzer. Press the symbol  again to select another timer.



## Use

6. If you leave the timer setting screen, the symbol  will be displayed at the top left, indicating that a minute minder timer is active.

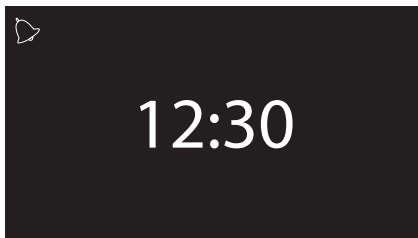

### Defrost by weight

1. Place the food inside the appliance.
2. Select **defrost by weight** from the "special functions" menu.

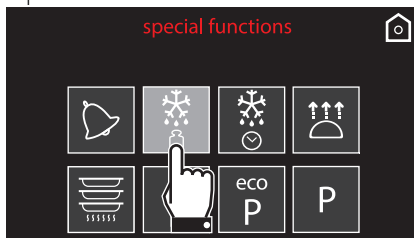

3. Select the type of food to defrost.

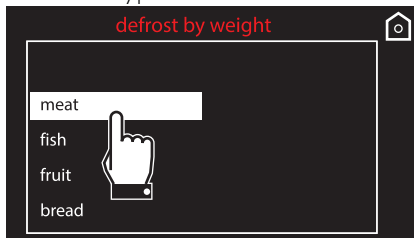

4. Use the symbols  and  to enter the weight (in kilograms) of the food to defrost.

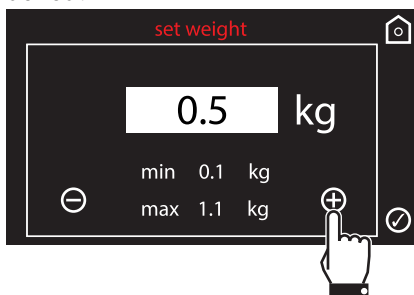

5. Press the symbol  to confirm.



You must return the counter to zero to remove the special timer.



If a function is activated after setting a timer time, this time will be automatically used as a timer for the function, except for some special functions, automatic preset recipes and personal recipes.



This function only activates the buzzer, without stopping cooking.



6. Select **start** to start defrosting, or select **change** to further modify the set parameters.

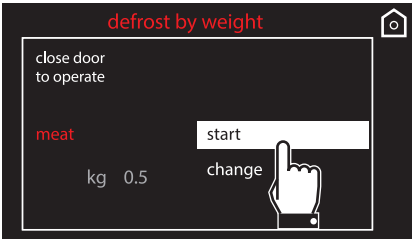

7. Press the symbol  to start the defrost by weight function.
8. The defrost by weight will start.



9. At the end of the function, "function ended" appears on the display and a buzzer will sound that can be deactivated by pressing the symbol .



Preset parameters:

Type	Weight (kg)	Time
Meat	0.5	01h 45m
Fish	0.4	00h 40m
Fruit	0.3	00h 45m
Bread	0.3	00h 20m

NE

## Defrost by time

1. Place the food inside the appliance.
2. Select **defrost by time** from the "special functions" menu.

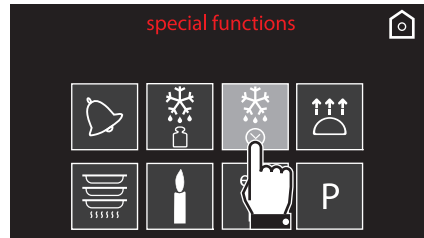

3. Enter the required duration (for example 1 hour: first touch the hours box, then the numbers 0 and 1).

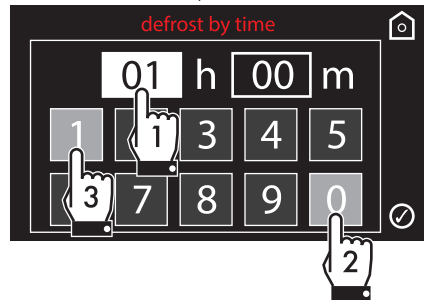

4. Press the symbol  to confirm.





# Use

5. Press the symbol  again to start the defrost by time function.

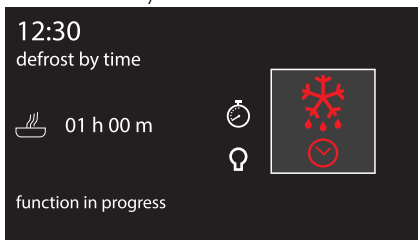
6. The defrost by time will start.



7. While the function is in progress, it is possible to further modify the defrosting duration (see "Timed cooking"). Press the symbol  to make the desired changes.

8. At the end of the function, "function ended" appears on the display and a buzzer will sound that can be deactivated by pressing the symbol .

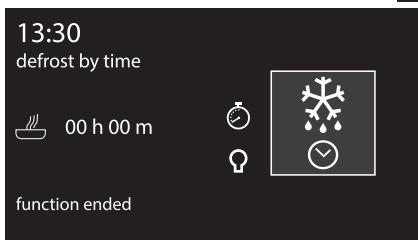

## Proving

 For successful proving, a container of water should be placed in the bottom of the oven.

1. Position the dough to prove on the second level.

2. Select **proving** from the "special functions" menu.

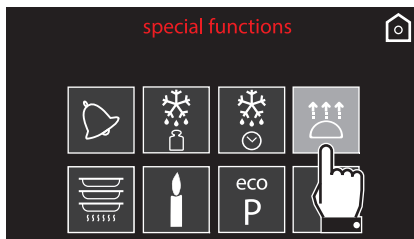

3. Press the symbol  to start the proving function.

4. The appliance will begin preheating.



5. It will then proceed with the selected function.





 The duration of the defrost by time can be from a minimum of 1 minute to a maximum of 13 hours.







6. While the function is in progress, it is possible to set a timer for a maximum of 4 hours (see "Timer during function"), a proving duration (see "Timed cooking") or a delayed proving (see "Delay cooking"). Press the symbol  to make the desired changes.

 Unless otherwise set, the proving will have a maximum duration of 13 hours.

 For optimum proving, the oven light is kept off, but it can be turned on at any time with the symbol .

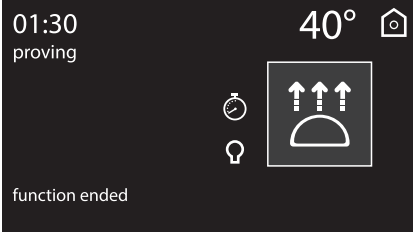
7. At the end of the function, "function ended" appears on the display and a buzzer will sound that can be deactivated by pressing the symbol .



 It is not possible to modify the default temperature of the proving function (40°C).

## Food warming

1. Position the tray on the first shelf and place the plates to be warmed at the centre of it.

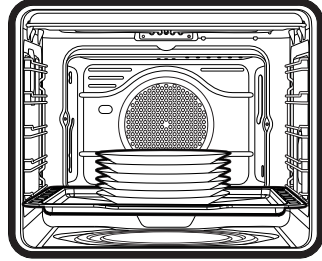

 Do not stack plates too high. Stack plates a maximum of 5/6 high.

2. Select **food warming** from the "special functions" menu.

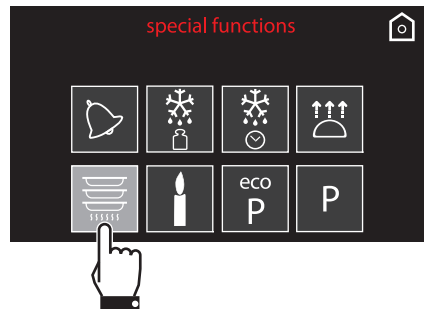



## Use

3. Press the symbol  to start the food warming function, or press the preset temperature value to change it (from 40° to 80° C).

4. The appliance will begin preheating.

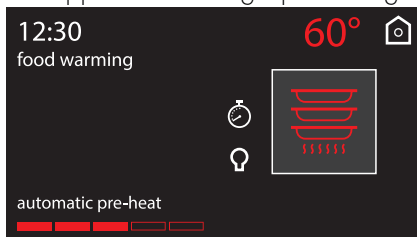

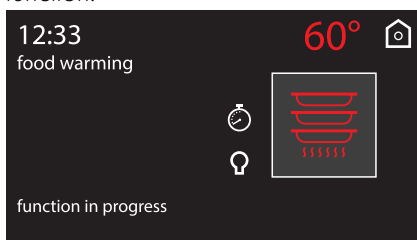

5. It will then proceed with the selected function.



6. While the function is in progress, it is possible to set a timer for a maximum of 4 hours (see "Timer during function"), a warming duration (see "Timed cooking") or a delayed warming (see "Delay cooking"). Press the  symbol to make the desired changes.

**i** Unless otherwise set, the food warming function will have a maximum duration of 13 hours.

7. At the end of the function, "function ended" appears on the display and a buzzer will sound that can be deactivated by pressing the symbol  or .

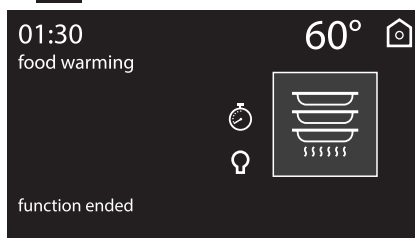



## Sabbath



The appliance follows some specific behaviour when operating in this function:

- Cooking can proceed indefinitely, it is not possible to set any cooking duration.
- No preheating will be performed.
- The cooking temperature which can be selected varies between 60-100 °C.
- Oven light disabled, any operation such as opening the door or manual activation will not activate the light.
- Oven fan disabled.
- Buzzers disabled.



After activating the Sabbath function it will no longer be possible to modify any parameters. Any action will produce no effect; only the return symbol  remains active to allow you to return to the main menu.

1. Select **sabbath** from the “special functions” menu.

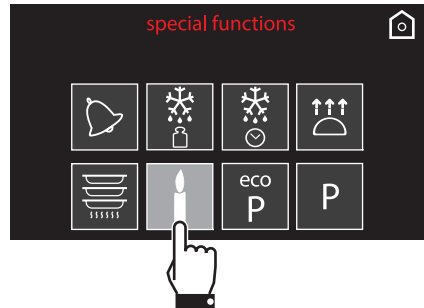

2. Press the symbol  to start the Sabbath function, or press the preset temperature value to change it (from 60° to 100° C).



3. When finished, press and hold the return symbol  to return to the main menu.





## 3.7 Preset recipes

This mode allows you to select a pre-set food cooking program. The appliance will automatically calculate the optimum cooking parameters based on the weight entered.

Select the **preset recipes**  icon on the "home screen".



### Starting a preset recipe

1. Press the symbols  and  to select the type of dish required from the "preset recipes" menu. Then press the name of the dish to confirm.



2. Select the sub-type of dish to cook and press the name of the sub-type of dish to confirm.

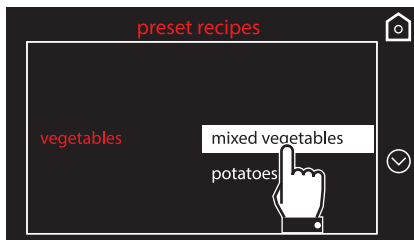

3. Select the type of cooking (where possible, depending on the dish chosen) and press the name of the cooking type to confirm.

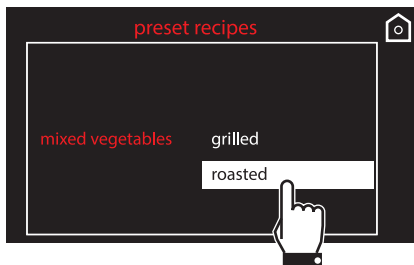



4. Press the symbol  to change the weight of the dish.



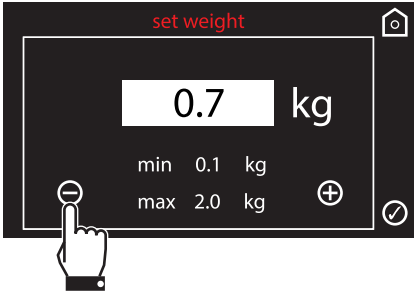

5. Use the symbols  and  to enter the weight (in kilograms) of the dish.



6. Press the symbol  to confirm.
7. Press the symbol  again to move to the next screen.
8. At this point it is possible to start the selected preset recipe, permanently modify the settings or perform delayed cooking.



9. If you choose the **start** option, cooking will start with the preset recipe's predefined settings and the display will show all the parameters set.

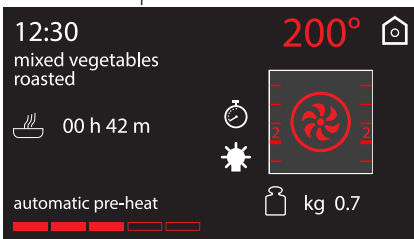

The time shown does not include the time to reach temperature.



Some predefined cooking parameters can be changed at any time, even after cooking has started.

EN

10. A buzzer will sound and a message will be displayed to indicate when to place the food in the oven and enable the start of cooking.

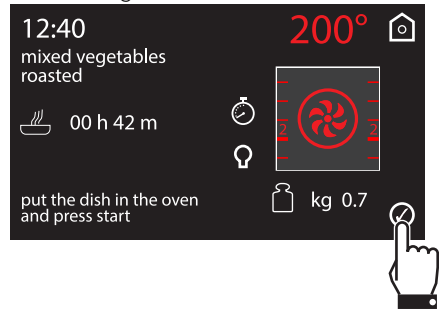

11. Press the  symbol to start cooking.

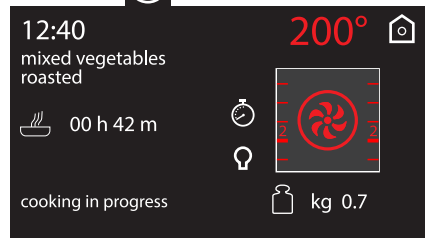





# Use

## Preset recipe end

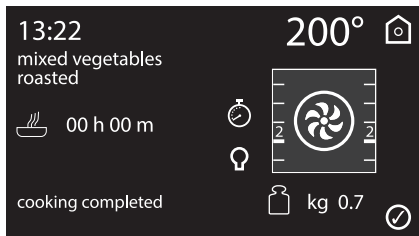
1. At the end of the preset recipe, the appliance will notify the user with a buzzer and the symbol  will flash.



2. Press the symbol  to perform cooking with the same parameters currently set (press the symbol twice if the buzzer is active). The appliance will automatically restart cooking if it is at the correct temperature; otherwise it will also resume preheating.

**i** Cooking in sequence is useful to cook multiple dishes of the same type. For example, it can be used to cook several pizzas in a row.

 It is not recommended to place the dish in the oven during the automatic pre-heat stage. Wait for the specific message.

3. Press and hold the return symbol  to exit and end the preset recipe.

## Changing a preset recipe permanently

1. Inside the selected preset recipe, select **change** from the menu of the selected dish.



All parameters which can be changed will be highlighted in yellow on the main screen.

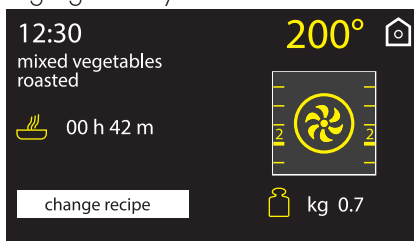

2. Press the parameter you wish to change:
  - Cooking temperature

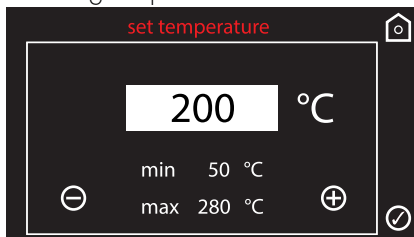



- Cooking function

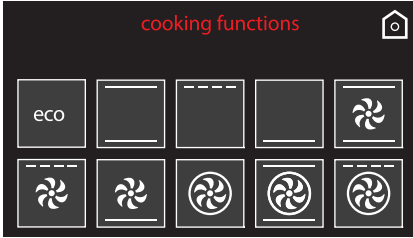

- Cooking time

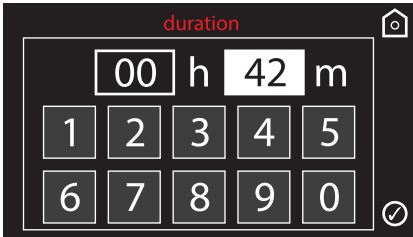

- Oven shelf



- Weight of dish

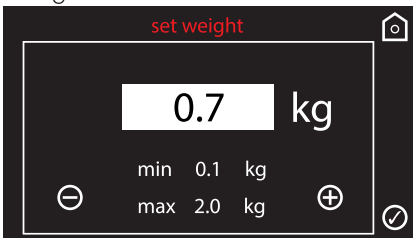

3. Make the required changes.

4. Press the symbol  to store the recipe. The appliance will ask to confirm the changes which have just been made.

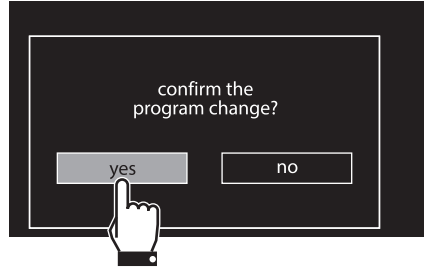

**i** If the changes are not confirmed, the preset recipe will remain unchanged.

5. If the change is confirmed the display will show confirmation of this.

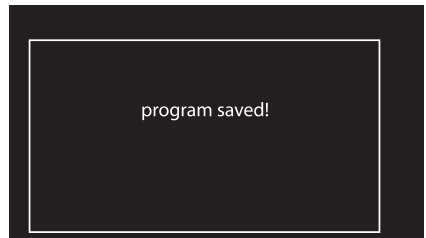

ZEN



# Use

## Preset recipe table

### MEATS

Subcategory	Cooking	Weight (Kg)	Function	Level	Temp. (°C)	Time (minutes)
Roast beef	rare	1	Circulaire	2	200	35
	medium	1	Circulaire	2	200	40
	well done	1	Circulaire	2	200	45
Roast pork	-	1	Turbo	2	190	75
Lamb	medium	1	Turbo	2	190	100
	well done	1	Turbo	2	190	110
Veal	-	1	Fan assisted	2	190	65
Pork spare ribs	-	1	Fan with grill	4	250	16
Pork chops	-	1	Fan with grill	4	280	15
Pork sausages	-	1	Fan with grill	4	280	12
Bacon	-	0.5	Fan with grill	4	250	7
Turkey	roasted	3	Fan assisted	1	190	110
Chicken	roasted	1	Turbo	2	200	64
Rabbit	roasted	1.5	Circulaire	2	190	80

### FISH

Subcategory	Cooking	Weight (Kg)	Function	Level	Temp. (°C)	Time (minutes)
Fresh fish	-	0.5	Fan assisted	2	160	35
Frozen fish	-	0.5	Circulaire	2	160	45
Sea bass	-	1	Circulaire	2	160	45
Monkfish	-	0.8	Circulaire	2	160	60
Snapper	-	1	Circulaire	2	180	30
Turbot	-	1	Circulaire	2	160	35

### VEGETABLES

Subcategory	Cooking	Weight (Kg)	Function	Level	Temp. (°C)	Time (minutes)
Mixed vegetables	grilled	0.5	Grill	4	250	25
	roasted	1	Circulaire	2	200	45
Potatoes	roasted	1	Turbo	2	220	40
	frozen	0.5	Fan assisted	2	220	13





## DESSERTS/PASTRIES

Subcategory	Cooking	Weight (Kg)	Function	Level	Temp. (°C)	Time (minutes)
Bundt cake	-	1	Fan assisted	2	160	60
Biscuits	-	0.6	Turbo	2	160	18
Muffins	-	0.5	Circulaire	2	160	18
Profiteroles	-	0.5	Turbo	2	180	70
Meringues	-	0.3	Turbo	2	120	90
Sponge cake	-	1	Circulaire	2	160	60
Strudel	-	1	Static	2	170	40
Tart	-	0.8	Static	2	170	40
Brioche bread	-	1	Fan assisted	2	180	40
Croissants	-	0.6	Circulaire	2	160	30

## BREAD

Subcategory	Cooking	Weight (Kg)	Function	Level	Temp. (°C)	Time (minutes)
Leavened bread	-	1	Circulaire	2	200	30
Focaccia	-	1	Turbo	2	180	25

## PIZZA

Subcategory	Cooking	Weight (Kg)	Function	Level	Temp. (°C)	Time (minutes)
Pan baked pizza	-	1	Fan assisted	1	280	7
Stone baked pizza	fresh	0.5	Fan assisted	1	280	4
	frozen	0.3	Fan assisted	1	230	6

## PASTA/RICE

Subcategory	Cooking	Weight (Kg)	Function	Level	Temp. (°C)	Time (minutes)
Pasta bake	-	2	Static	1	220	40
Lasagne	-	2	Static	1	230	35
Paella	-	0.5	Fan assisted	2	190	25
Quiche	-	0.5	Static	1	200	30
Soufflé	-	0.5	Circulaire	2	180	25



# Use

## LOW TEMPERATURE COOKING

Subcategory	Cooking	Weight (Kg)	Function	Level	Temp. (°C)	Time (minutes)
Veal	-	1	Turbo	2	90	360
Beef	rare	1	Static	2	90	105
	well done	1	Static	2	90	380
Pork	-	1	Turbo	2	90	330
Lamb	-	1	Turbo	2	90	360



The cooking times in the table refer to the dish indicated in the recipe and are a guide only; they may vary depending on personal taste.



The tables give the factory-set data. To reset a preset recipe with the original settings after it has been modified, just enter the data given in the table.



If ECO logic mode (see 3.9 Settings) has been activated, cooking times or preheating times may vary.

### 3.8 Personal programs

This menu allows you to enter a personal program with the parameters you wish to use. On first use, the appliance will only offer to let you add a new recipe. After storing your recipes, these will then be available in the relative menu.

Select the **personal programs**  icon on the "home screen".



Up to 10 personal recipes can be stored.



## Adding a recipe

1. Select **add** from the "personal recipes" menu.

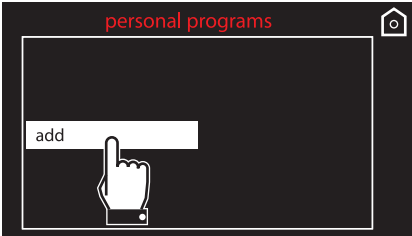

All parameters which can be changed will be highlighted in yellow on the main screen.

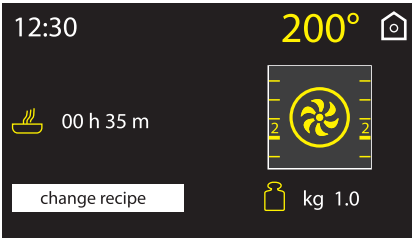

2. Press the parameter you wish to change:

- Cooking temperature

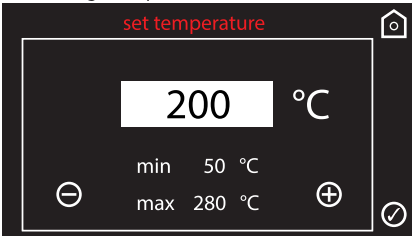

- Cooking function

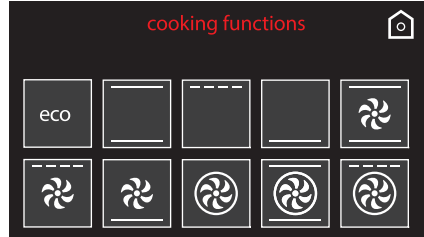

- Cooking time

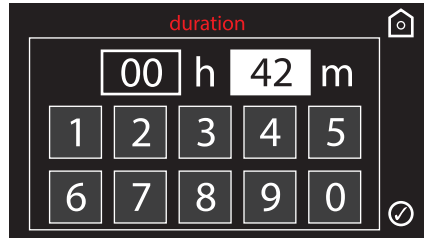

- Oven shelf



- Weight of dish

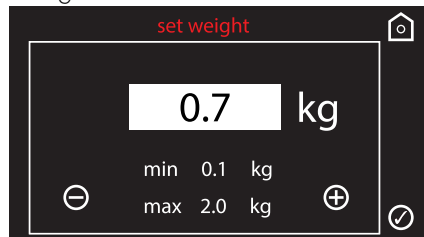

3. Make the required changes.





## Use

4. Press the symbol  to store the recipe. The appliance will ask you to enter a name for the recipe you have just created.



5. Enter the name of the recipe. The character  deletes the previous letter (in the example, the recipe, **recipe 1** has been stored).

 The recipe name can contain maximum 10 characters, including spaces.

 In order to be able to save the recipe, the name must contain at least one character.

6. After entering the name of the new recipe, press the symbol  to confirm.

7. The appliance will ask to confirm the changes which have just been made. Select **yes** if you wish to store the recipe.

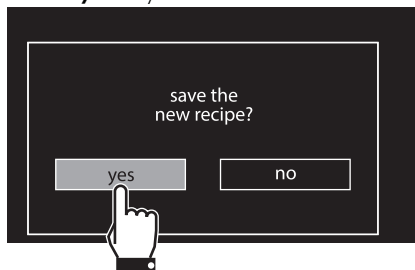

 If you select **no** you will lose all changes made.

8. If saving the recipe is confirmed the display will show confirmation of this.





## Starting a personal recipe

1. Select a previously saved **personal recipe** from the “personal recipes” menu (in the example the recipe, **recipe 1**, has been saved).

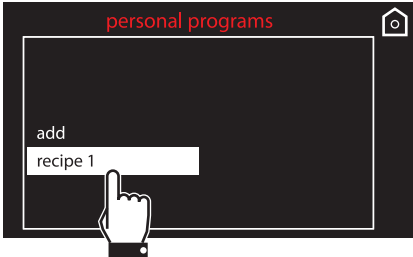

2. Select the **start** option.

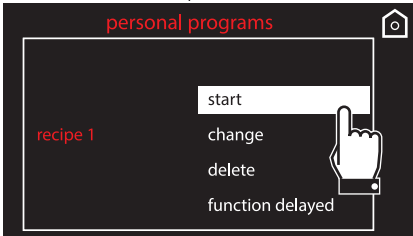

3. Cooking will start with the parameters previously set for the recipe.



During cooking it is always possible to modify the temperature and cooking time, but this will not be saved to the recipe for future use.

## Changing a personal recipe

1. Select a previously saved **personal recipe** from the “personal recipes” menu (in the example the recipe, **recipe 1** has been saved).

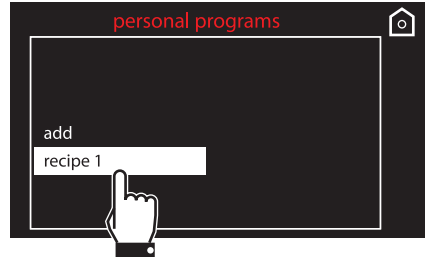

2. Select the **change** option.

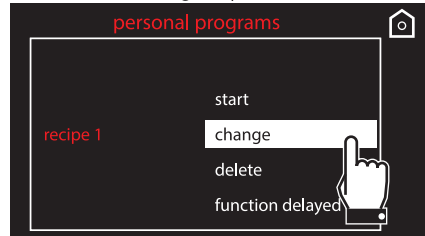

3. Repeat the same steps, starting at point 2 of the chapter “Adding a recipe”.

## Deleting a personal recipe

1. Select a previously saved **personal recipe** from the “personal recipes” menu (in the example the recipe **recipe 1** has been saved).

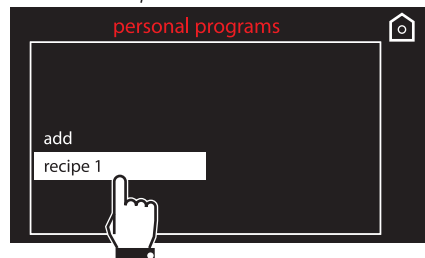



2. Select the **delete** option.

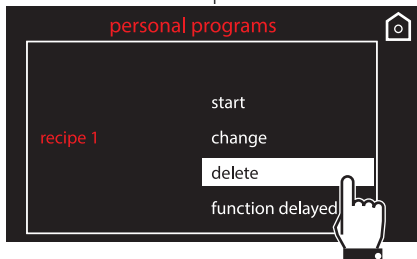

3. Confirm the deletion. Select **yes** to permanently delete the recipe.



4. If you confirm the deletion, the display will show confirmation of this.



## Delay cooking

1. Select a previously saved **personal recipe** from the "personal recipes" menu (in the example the recipe, **recipe 1** has been saved).

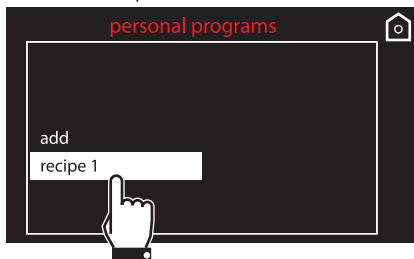

2. Select the **function delayed** option.

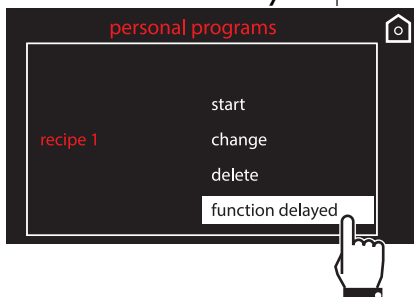

3. Enter the time at which you require cooking to end (for example at 7:30 p.m.: first touch the hours box, then the numbers 1 and 9; touch the minutes box, then the numbers 3 and 0).

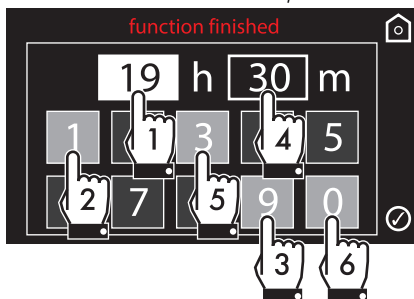



- Press the symbol  to confirm.
- The appliance waits for the delay start time.

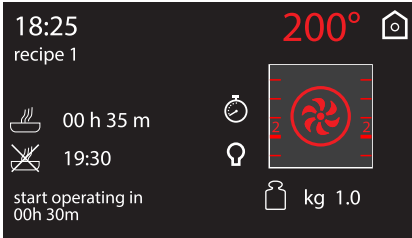

### 3.9 Settings

The product is set using this menu.

Select the **settings**  icon on the “home screen”.



 In the event of a temporary power cut, all personal settings will remain stored.

### Language

 Sets the interface language from those available.

- Select **language** from the “settings” menu.

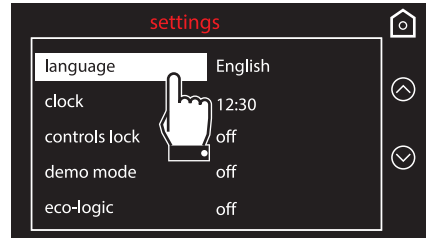

- Press the symbols  and  to select the required language.

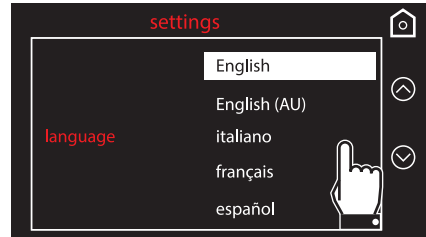

- Confirm the selected language.



# Use

## Clock



Sets the time displayed.

1. Press the symbol or and select **clock** from the "settings" menu.

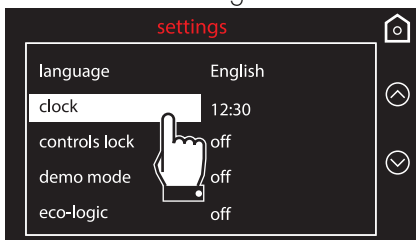

2. Enter the current time

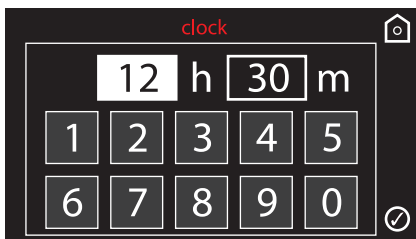

3. Press the symbol to confirm.

## Control lock



Allows the appliance to automatically lock the controls after one minute of normal operation without any intervention from the user.

1. Press the symbol or and select **controls lock** from the "settings" menu.

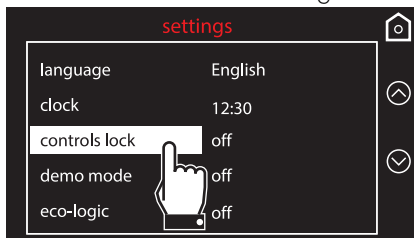

2. To confirm activation of the controls lock, select **yes**.



During normal operation it is indicated by the indicator light coming on.



To temporarily release the lock during cooking, press and hold the symbol for 3 seconds. One minute after the last setting the lock will become active again.





## Demo mode (for showrooms only)

**i** This mode deactivates all the appliance's heating elements, while keeping the control panel active.

1. Press the symbol  or  and select **demo mode** from the "settings" menu.

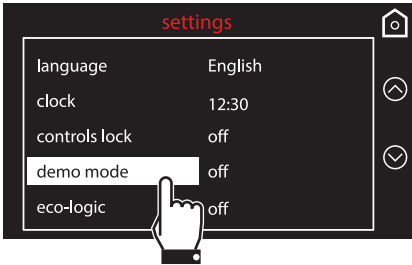

2. To confirm activation of demo mode, select **yes**.

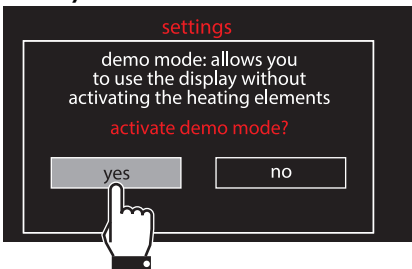

**i** If the mode is active, "demo mode" will be shown on the display.

 To use the appliance normally, set this mode to **OFF**.

## Eco-Logic

**i** This mode allows the appliance to limit the power used. Indicated for use of multiple appliances at the same time on circuits with limited maximum power.

If this option is enabled, the symbol  will appear next to the function on the display.

1. Press the symbol  or  and select **eco-logic** from the "settings" menu.

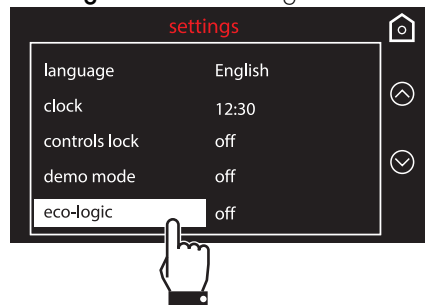

2. To confirm activation of eco-logic mode, select **yes**.

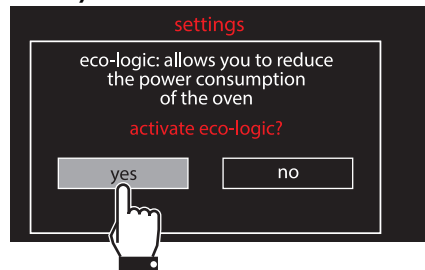

 When eco-logic mode is active, preheating and cooking times may be extended.



# Use

## Sound

**i** Whenever one of the display symbols is pressed, the appliance beeps. This setting disables these sounds.

1. Press the symbol  or  and select **sound** from the “settings” menu.

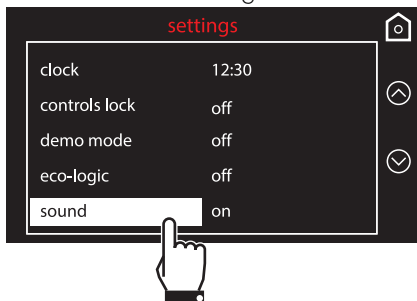

2. Select **no** to disable the sounds associated with pressing the symbols.

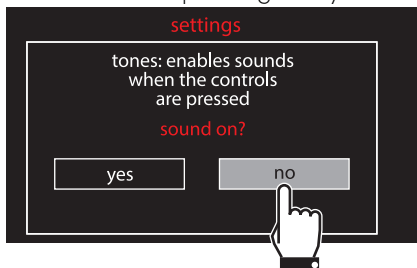

## Keep warm

**i** This mode allows the appliance to keep cooked food warm (at low temperatures) after cooking finishes with a cooking cycle for which a duration has been set (if this is not manually interrupted), without altering the taste and smell obtained during cooking.

1. Press the symbol  or  and select **keep warm** from the “settings” menu.

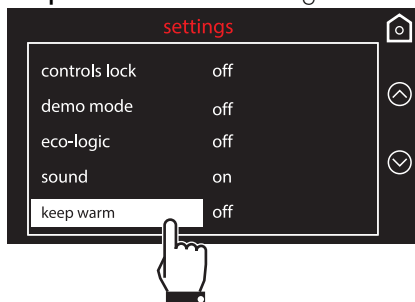

2. To confirm activation of the keep warm function, select **yes**.





**i** The keep warm function will be activated as soon as cooking is finished; this is indicated by a series of beeps (see cooking or function finished). The screen below will be shown on the display after a few minutes.

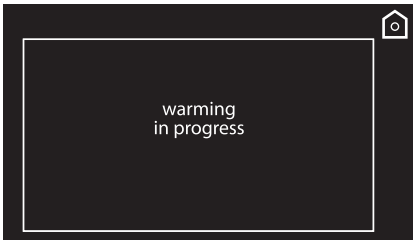

## Eco-Light

**i** For greater energy savings, the light is automatically deactivated one minute from the start of cooking.

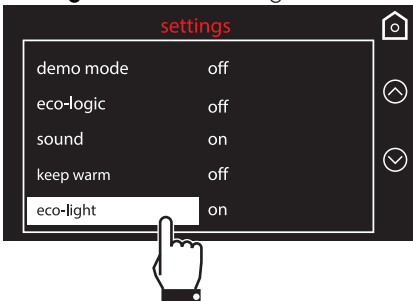

1. Press the symbol  or  and select **eco-light** from the "settings" menu.

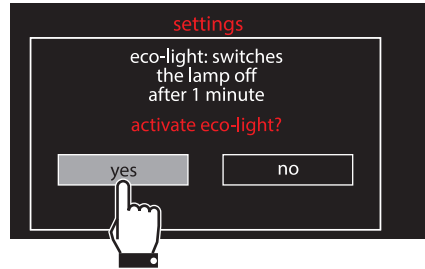

2. To confirm activation of eco-light mode, select **yes**.



 To stop the appliance from automatically deactivating the light after one minute, set this mode to OFF.

 Manual on/off control is always available. Press the symbol  when available, to manually activate the oven light or the symbol  to deactivate it.

**i** The eco-light function is "on" by default (factory setting).



# Use

## Digital clock



Displays the time in digital format.

1. Press the symbol  or  and select **digital clock** from the “settings” menu.

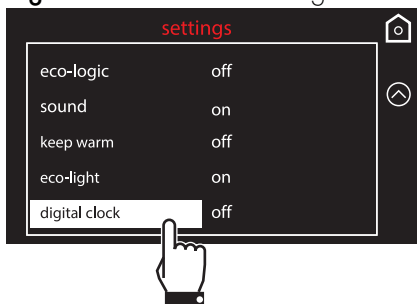

2. To confirm activation of the digital clock, select **yes**.

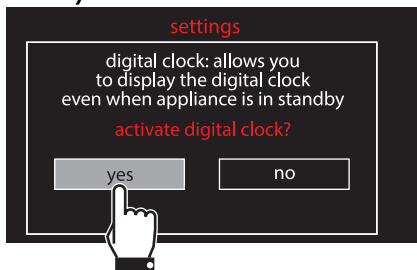

When no appliance function is active, the display will show the current time in digital format.

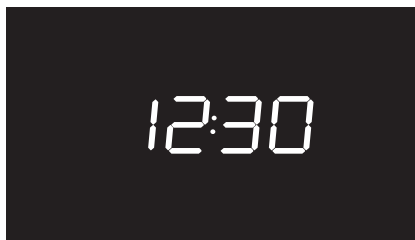

In the event of a temporary power cut, the digital version will remain selected.



## 4 Cleaning and maintenance

### 4.1 Instructions



**Improper use  
Risk of damage to surfaces**

- Do not use steam jets to clean the appliance.
- Do not use cleaning products containing chlorine, ammonia or bleach on parts made of steel or that have metallic surface finishes (e.g. anodizing, nickel- or chromium-plating).
- Do not use abrasive or corrosive detergents (e.g. scouring powders, stain removers and metallic sponges) on glass parts.
- Do not use rough or abrasive materials or sharp metal scrapers.

### 4.2 Cleaning the appliance



We recommend the use of cleaning products distributed by the manufacturer.

### Recommendations for cleaning the oven cavity

In order to keep your oven in the best possible condition, clean it regularly after letting it cool down.

Avoid letting food residue dry inside the oven cavity, as this could damage the enamel.

Take out all removable parts before cleaning.

For easier cleaning, we recommend removing:

- The door;
- The rack/tray support frames;
- the seal (excluding pyrolytic models).



In the event you are using specific cleaning products, we recommend running the oven at maximum temperature for 15-20 minutes in order to eliminate any residue.

### 4.3 Removing the door

For easier cleaning it is recommended to remove the door and place it on a tea towel.

To remove the door proceed as follows:

1. Open the door completely and insert two pins into the holes on the hinges indicated in the figure.

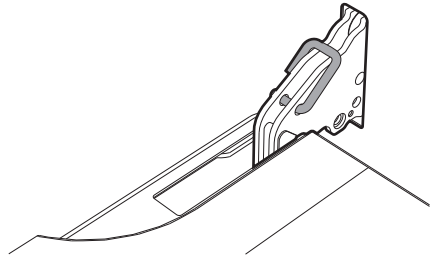



## Cleaning and maintenance

2. Grasp the door on both sides with both hands, lift it forming an angle of around  $30^\circ$  and remove it.

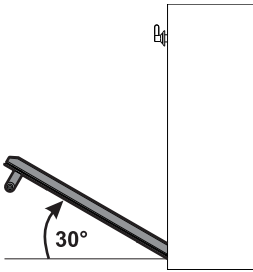

3. To reassemble the door, put the hinges in the relevant slots in the oven, making sure that grooved sections **A** are resting completely in the slots. Lower the door and once it is in place remove the pins from the holes in the hinges.

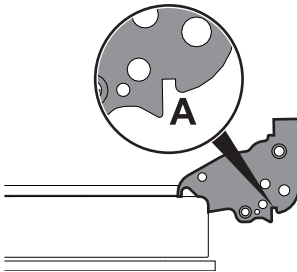

### 4.4 Cleaning the door glazing

The glass in the door should always be kept thoroughly clean. Use absorbent kitchen roll. In case of stubborn dirt, wash with a damp sponge and an ordinary detergent.

#### Removing the internal glass panes

For easier cleaning the internal glass panes of the door can be removed.

1. Remove the internal glass pane by pulling the rear part gently upwards, following the movement indicated by the arrows (1).
2. Then, pull the front part upwards (2). This way, the 4 pins attached to the glass detach from their housings in the oven door.

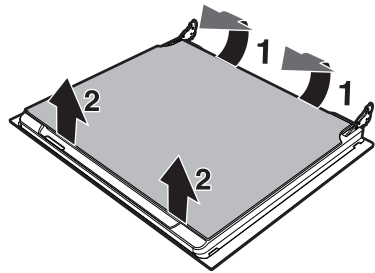



3. Some models have an intermediate glass pane. Remove the intermediate glass pane by lifting it upwards.

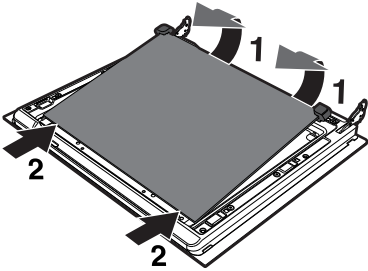

4. Clean the external glass pane and the panes removed previously. Use absorbent kitchen roll. In case of stubborn dirt, wash with a damp sponge and neutral detergent.

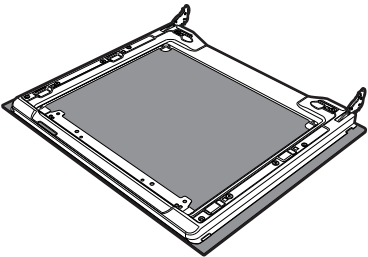

5. Refit the panes in the reverse order in which they were removed.

6. Reposition the internal glass pane. Take care to centre and insert the 4 pins into their housings in the oven door by applying slight pressure.

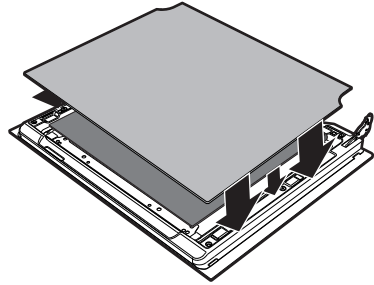

## Removing racks/trays support frames

Removing the rack/tray support frames enables the sides to be cleaned more easily. This operation should be performed each time the automatic cleaning cycle is used (on some models only).

To remove the rack/tray support frames:

1. Pull the frame towards the inside of the oven cavity to unhook it from groove **A**.
2. Then slide it out of the seats at the back **B**.
3. When cleaning is complete, repeat the above procedures to put the rack/tray support frames back in.

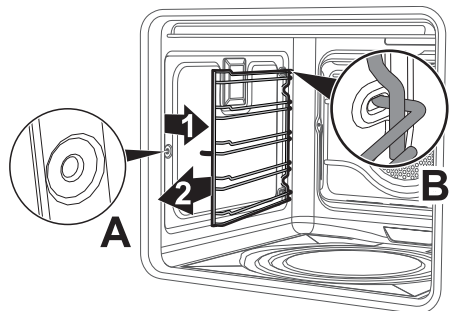



## Cleaning and maintenance

### Cleaning the top of the compartment (excluding pyrolytic models)



High temperature inside the oven during use

#### Danger of burns

- The following operations must be performed only with the oven switched off and completely cool.

The appliance is equipped with a tilting grill element that allows for easy cleaning of the upper part of the oven compartment.

1. Free the upper heating element by gently lifting it and rotating its retaining latch by 90 degrees.

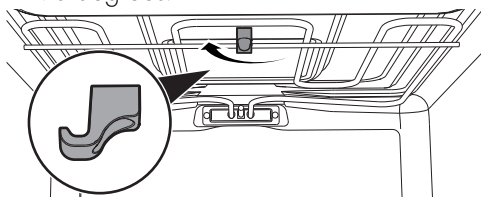

2. Gently lower the heating element until it stops.

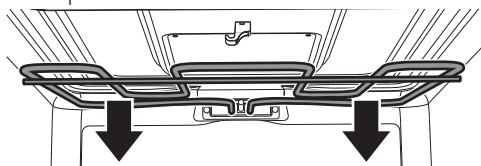

Improper use

#### Risk of damages to the appliance

- Do not excessively flex the element during cleaning.

3. When you have finished cleaning, place the heating element back in position and turn the retaining latch to lock it in place.

### 4.5 Vapor Clean (on some models only)



Vapor Clean is an assisted cleaning procedure which facilitates the removal of dirt. Thanks to this process, it is possible to clean the inside of the oven very easily. The dirt residues are softened by the heat and water vapour for easier removal afterwards.



Improper use

#### Risk of damage to surfaces

- Remove any food residues or large spills from previous cooking operations from the inside of the oven.
- Carry out assisted oven cleaning operations only when the oven is cold.

### Preliminary operations

Before starting the Vapor Clean function:

- Completely remove all accessories from inside the oven. The upper guard can be left inside the oven.



# Cleaning and maintenance



- Pour approx. 40 cc of water onto the floor of the oven. Make sure it does not overflow out of the cavity.

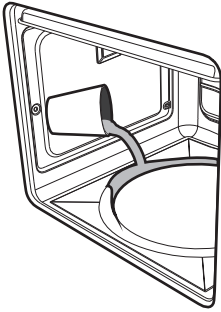

- Spray a water and washing up liquid solution inside the oven using a spray nozzle. Direct the spray against the side walls, upwards, downwards and towards the deflector.

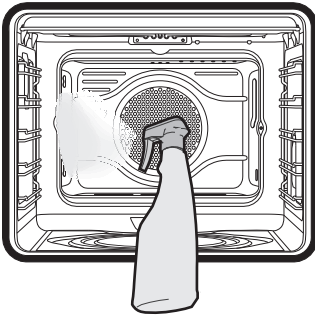

- Close the door.



We recommend spraying approx. 20 times at the most.

## Vapor Clean setting

**i**

If the internal temperature is greater than that required for the Vapor Clean function, the cycle will be stopped immediately and "Internal temperature unsafe, please wait until the oven is cool" will appear on the display. Leave the appliance to cool down before activating the assisted cleaning cycle.

1. Select the **Vapor Clean** function from the "special functions" menu.

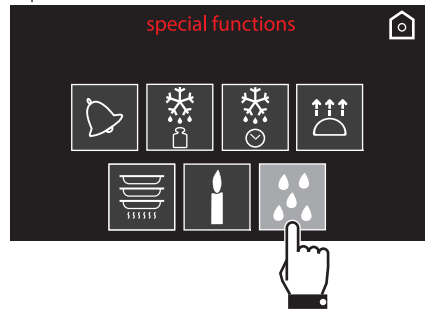

2. The duration and temperature of the cleaning cycle will appear on the display.

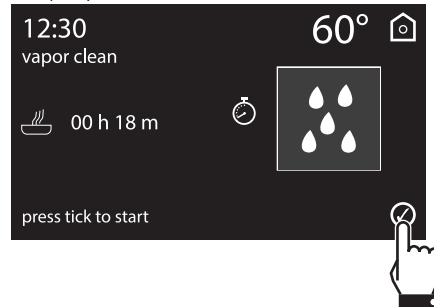

**i**

The duration and temperature parameters cannot be modified by the user.



## Cleaning and maintenance

3. Press the symbol  to confirm. The assisted cleaning cycle will start.

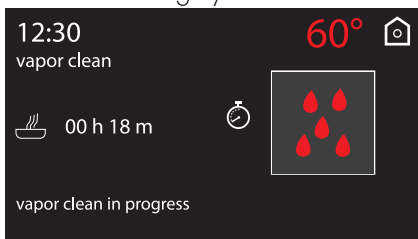

4. If the temperature inside the oven is too high, a warning buzzer and message on the display will instruct you to wait for it to cool.

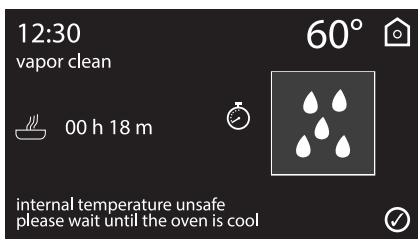

5. A buzzer will indicate the end of the Vapor Clean cycle.

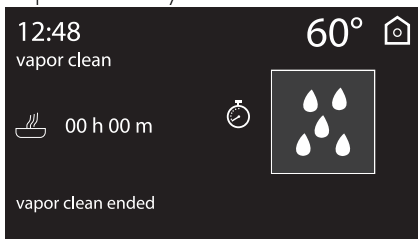

### Setting programmed Vapor Clean

It is possible to program the Vapor Clean start time, like any cooking function.

1. After selecting the Vapor Clean special function, press the symbol .

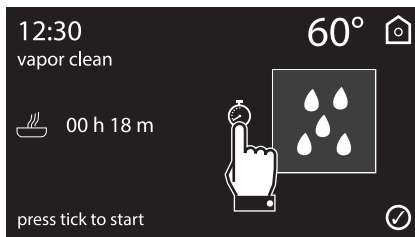

2. Enter the time at which you require the Vapor Clean function to end (for example at 7:30 p.m. first touch the hours box, then the numbers 1 and 9; touch the minutes box, then the numbers 3 and 0).

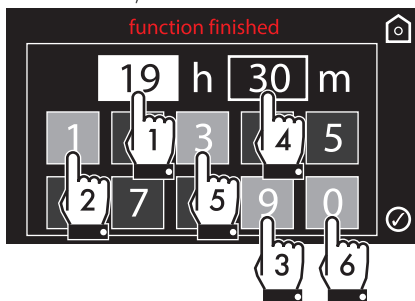

3. Press the symbol  to confirm.
4. The appliance waits until the set start time to start the cleaning cycle.



## End of the Vapor Clean cycle

5. Open the door and wipe away the less stubborn dirt with a microfibre cloth.
6. Use an anti-scratch sponge with brass filaments on tougher encrustations.
7. In case of grease residues use specific oven cleaning products.
8. Remove the water left inside the oven.

For improved hygiene and to avoid food being affected by any unpleasant odours, we recommend that the oven is dried using a fan assisted function at 160°C for approximately 10 minutes.



We recommend wearing rubber gloves for these operations.



For easier manual cleaning of the parts difficult to reach, we recommend removing the door.

## 4.6 Pyrolytic (on some models only)



Pyrolytic is an automatic high-temperature cleaning procedure which causes dirt to dissolve. Thanks to this process, it is possible to clean the inside of the oven very easily.



### Improper use Risk of damage to surfaces

- Remove any food residues or large spills from previous cooking operations from the inside of the oven.
- Switch off the burners or electric hot plates of the hob installed above the oven.

## Preliminary operations

Before starting the pyrolytic cycle:

- Clean the internal glass pane following the usual cleaning instructions.
- For very stubborn encrustations spray an oven cleaning product onto the glass (read the warnings on the product); leave for 60 minutes, then rinse and dry the glass using kitchen roll or a microfibre cloth.
- Completely remove all accessories from inside the oven.
- Remove the racks/trays support frames.
- Remove the upper guard (when fitted).
- Close the door.



# Cleaning and maintenance

## Pyrolytic function setting

1. Select **eco pyrolytic** or **pyrolytic** from the “special functions” menu.

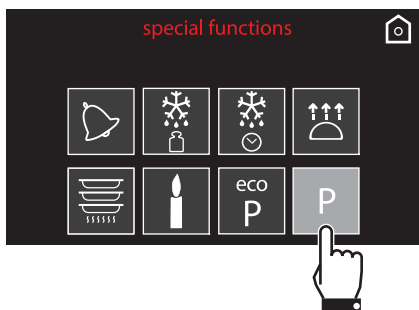
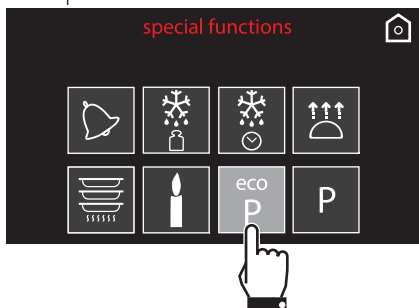

2. Enter the required duration of the cleaning cycle (for example 2 hours and 30 minutes: first touch the minutes box, then the numbers 3 and 0).

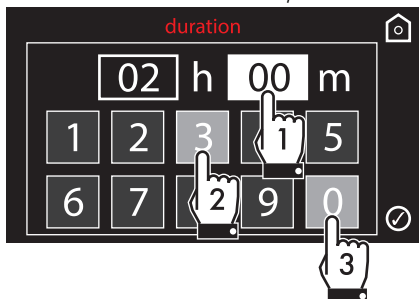

3. Press the symbol  to confirm.

4. The appliance is ready to start the automatic cleaning cycle. A warning reminds the user to remove any accessories from inside the oven. Press the symbol  to start pyrolytic cleaning.

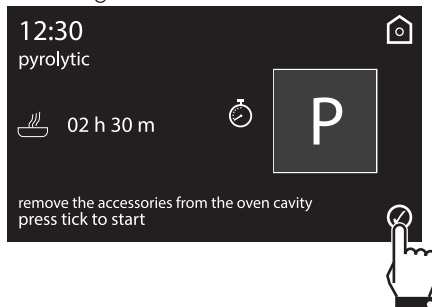

Recommended pyrolytic cycle duration:

- Light dirt: 2 hours.
- Medium dirt: 2 ½ hours.
- Heavy dirt: 3 hours.





With the **eco pyrolytic**  function, the duration is set to 2 hours and cannot be modified).

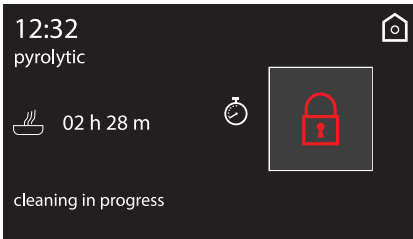

## Pyrolytic cycle

The display shows “cleaning in progress” and the remaining time to indicate that the appliance is carrying out the automatic cleaning cycle. Two minutes after the pyrolytic cycle has started the door is locked (the door lock indicator light  comes on) by a device that prevents the door from being opened.



 It is not possible to select any function once the door lock device has been activated. It remains possible, however, to switch off the appliance using the specific controls.

5. At the end of the pyrolytic cycle, the door remains locked as long as the temperature inside the oven returns to safety levels.

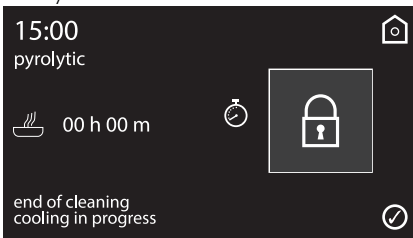



6. After around 20 seconds, the display will indicate that the cooling procedure is in progress.



7. Wait for the oven to cool down and collect the residues deposited inside with a damp microfibre cloth.

 During the first pyrolytic cycle, unpleasant odours may occur due to the normal evaporation of oily manufacturing substances. This is an absolutely normal phenomenon which disappears after the first pyrolytic cycle.

 During the pyrolytic cycle the fans produce a more intense level of noise due to a greater rotation speed. This is an absolutely normal operation, intended to provide more effective heat dispersal. At the end of the pyrolytic cycle, the fans will continue to operate for long enough to avoid overheating the walls of adjacent units and the front of the oven.

 If the pyrolytic cycle gives unsatisfactory results at minimum duration, it is recommended to set a longer time for successive cleaning cycles.

NE



# Cleaning and maintenance

## Setting of programmed pyrolytic cycle

It is possible to program the pyrolytic cycle start time like all other cooking functions.

1. After choosing the duration of the pyrolytic function and pressing the symbol  to confirm, press the symbol



2. Press on **function delayed**.

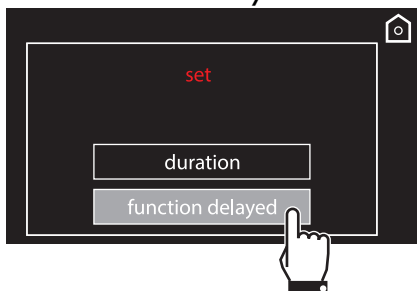

3. Enter the time at which you require cooking to end (for example at 7:30 p.m.: first touch the hours box, then the numbers 1 and 9; touch the minutes box, then the numbers 3 and 0).

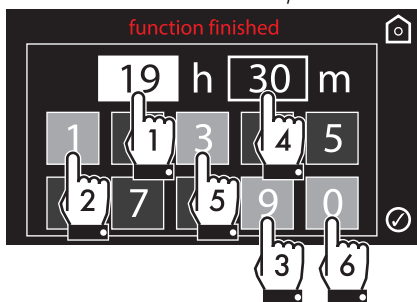

4. Press the symbol  to confirm.
5. The appliance waits until the set start time to start the cleaning cycle.

## 4.7 Extraordinary maintenance

### Removing and installing the door seal (not on pyrolytic models)

To remove the seal:

- Unhook the clips in the 4 corners then pull the seal outwards.

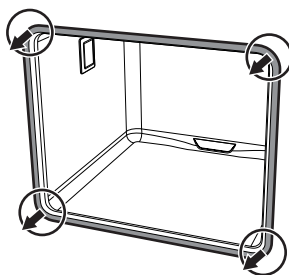

To refit the seal:

- Hook the clips in the 4 corners onto the seal.

### Seal maintenance tips

The seal should be soft and elastic.

- To keep the seal clean, use a non-abrasive sponge and wash with lukewarm water.



Live parts

**Danger of electrocution**

- Disconnect the oven power supply.



## Replacing the internal light bulb



Live parts  
**Danger of electrocution**

- Unplug the appliance.

1. Completely remove all accessories from inside the oven.
2. Remove the rack/tray support frames.
3. Remove the bulb cover using a tool (e.g. a screwdriver).



Pay attention not to scratch the oven cavity enamel.

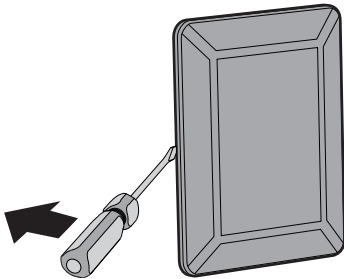

4. Slide out and remove the light bulb.

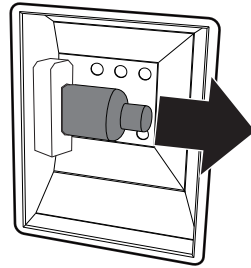

Do not touch the halogen light bulb directly with your fingers, but wrap it in insulating material.

5. Replace the light bulb with one of the same type (40W).
6. Refit the cover. Ensure the moulded part of the glass (**A**) is facing the door.

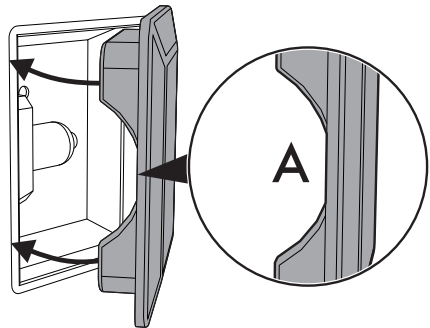

7. Press the cover completely down so that it attaches perfectly to the bulb support.



## Cleaning and maintenance

### What to do if...

The display is completely off:

- Check the mains power supply.
- Check that any circuit breakers upline of the appliance supply line are in the "ON" position.

The appliance does not heat up:

- Check whether it has been set in "demo" mode (for further details see "Settings").

The controls do not respond:

- Check whether it has been set to "control lock" mode (for further details see "Settings").

The cooking times are longer than those indicated in the table:

- Check whether it has been set to "eco-logic" mode (for further details see "Settings").

After the (pyrolytic) automatic cleaning cycle it is not possible to select a function:

- Verify whether the door lock has deactivated. If it has not, the oven has a safety device that does not allow functions to be selected while the door lock is active. This is because the temperature inside the oven is still too high to permit any type of cooking.

The display shows "Error 4":

- The door lock has not properly attached to the door. This might be because the door was accidentally opened during the door lock activation. Switch the oven off and on again, waiting a few minutes before selecting a new cleaning cycle.

If the door is opened during a fan assisted function, the fan stops:

- This is not a fault. It is a normal operation of the appliance, useful when cooking foods in order to avoid excessive heat escaping. When the door is closed, the oven will return to normal operation.



If the problem has not been resolved or in the case of other types of fault, contact your local technical support centre.



If other Error XX error messages are indicated:  
note down the error message, function and set temperature and contact your local technical support centre.





## 5 Installation

### 5.1 Electrical connection



**Power voltage**  
**Danger of electrocution**

- Have the electrical connection performed by authorised technical personnel.
- The appliance must be connected to earth in compliance with electrical system safety standards.
- Disconnect the mains power supply.

#### General information

Check the grid characteristics against the data indicated on the plate.

The identification plate bearing the technical data, serial number and brand name is visibly positioned on the appliance.

Do not remove this plate for any reason. The appliance operates at 220-240 V $\sim$ .

Use a three-core cable (3 x 1.5 mm<sup>2</sup> internal conductors).

Perform the ground connection using a wire that is 20 mm longer than the other wires.

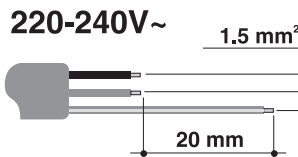

#### Fixed connection

Fit the power line with an omnipolar circuit breaker in compliance with installation regulations.

The circuit breaker should be located near the appliance and in an easily reachable position.

#### Connection with plug and socket

Make sure that the plug and socket are of the same type.

Avoid using adapters and shunts as these could cause overheating and a risk of burns.

### 5.2 Cable replacement



**Power voltage**  
**Danger of electrocution**

- Disconnect the mains power supply.

1. Unscrew the rear casing screws and remove the casing to access the terminal board.

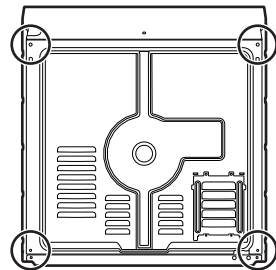

2. Replace the cable.
3. Make sure that the cables (for the oven or any hob) follow the best route in order to avoid any contact with the appliance.



# Installation

## 5.3 Positioning



**Heavy appliance**  
**Crushing hazard**

- Position the appliance into the cabinet cutout with the help of a second person.



**Pressure on the open door**  
**Risk of damage to the appliance**

- Never use the oven door to lever the appliance into place when fitting.
- Avoid exerting too much pressure on the oven door when open.



**Heat production during appliance operation**  
**Risk of fire**

- Check that the carcass material is heat resistant.
- Check that the carcass has the required openings.
- Do not install the appliance in a recess which can be closed with a door, or in a cupboard.

## Position of the power cable

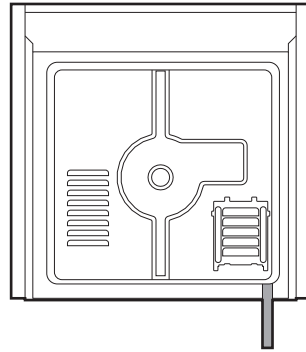

(rear view)

## Front panel seal

Glue the supplied seal to the rear part of the front panel to avoid water or other liquids from leaking in.

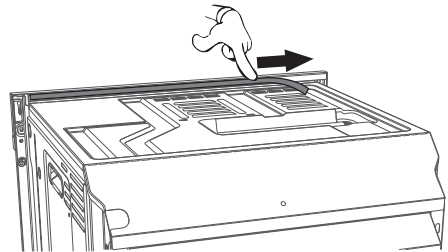



## Fastening bushings

1. Remove the bushing covers inserted on the front of the appliance.

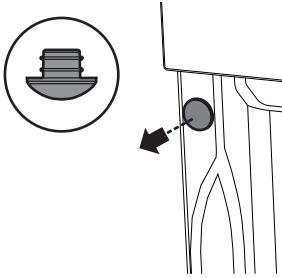

2. Mount the appliance into the recess.
3. Secure the appliance to the carcass using the screws.

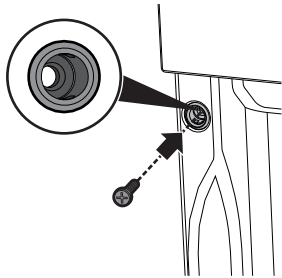

4. Cover the bushings with the previously removed covers.

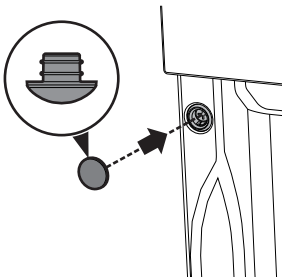

## Appliance overall dimensions (mm)

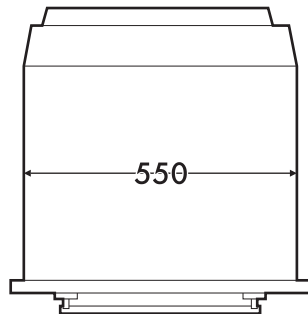
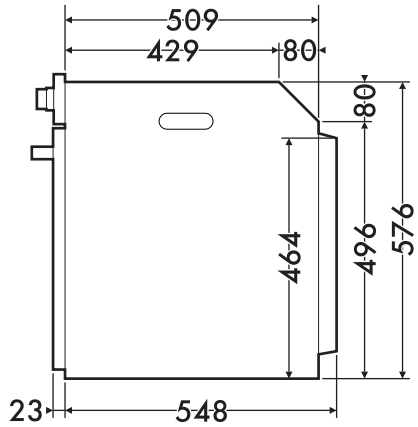
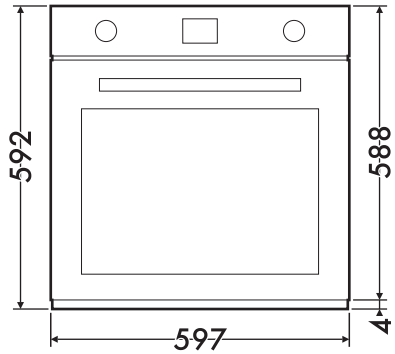

EN



# Installation

## Mounting under worktops (mm)

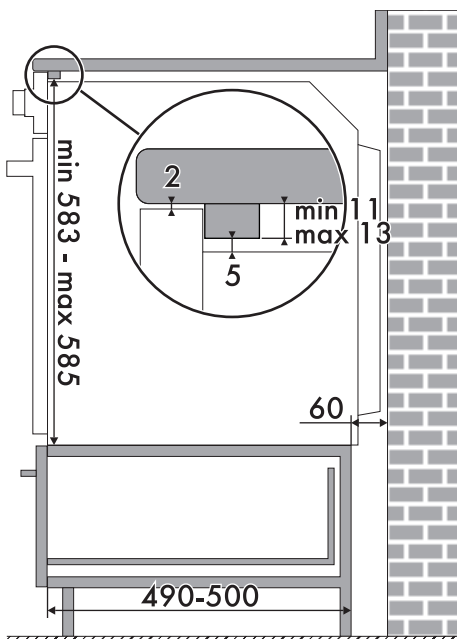
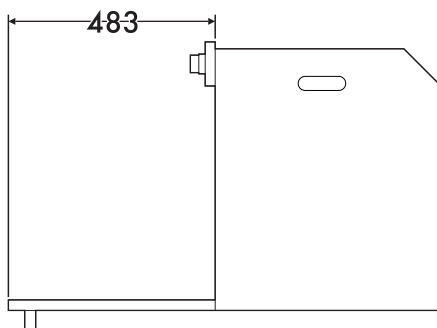
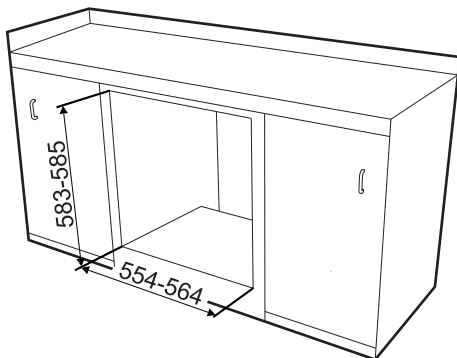
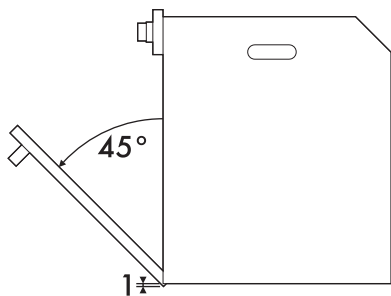

Make sure that the carcass rear/  
bottom section has an opening of  
approx. 60 mm.



## Mounting into a column (mm)

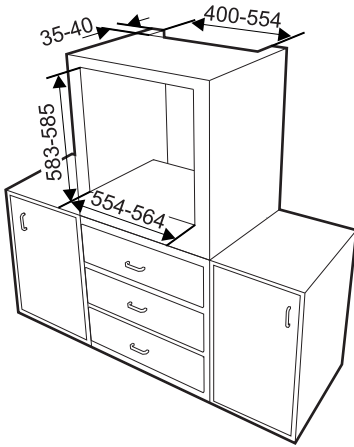

Make sure that the carcass top/rear section has an opening approx. 35-40 mm deep.

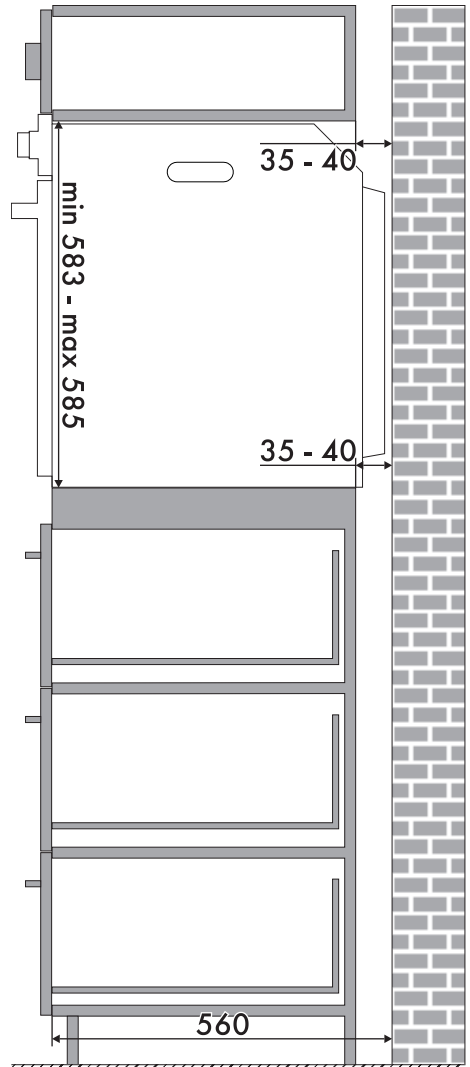

EN

