



**MEADE**<sup>®</sup>  
[www.meade.com](http://www.meade.com)

# MEADE INSTRUCTION MANUAL

## Polaris Series German Equatorial Telescopes



**POLARIS SERIES**



## **WARNING!**

**Never use a Meade® Telescope to look at the Sun!**

Looking at or near the Sun will cause instant and irreversible damage to your eye. Eye damage is often painless, so there is no warning to the observer that damage has occurred until it is too late. Do not point the telescope at or near the Sun. Do not look through the telescope or viewfinder as it is moving. Children should always have adult supervision while observing.

## INTRODUCTION

Your telescope is an excellent beginner's instrument, and is designed to observe objects in the sky. It can be your personal window to the universe allowing you to see bright galaxies, planets, stars and more.

The telescope is shipped with the following parts:

- Optical tube
- German equatorial mount
- Stainless-steel tripod with accessory tray
- Three 1.25" eyepieces:
  - MA25mm, MA9mm, MA6.3mm
- Red dot viewfinder with bracket
- Slow-motion control cables
- 90 degree erect-image diagonal prism (Refractors only)

The Polaris Series of telescope includes optical tubes of different sizes and design. Some optical tubes use lenses to focus the incoming light and are called refractors. Other

optical tubes use mirrors to bring the incoming light to focus and are called reflectors.

The lens or mirror diameter of the telescope is one of the most important pieces of information about the telescope. The size of the lens or mirror, also known as "aperture", determines how much detail you will be able to see in your telescope. The optical tubes focal length information is also important and will help later on to calculate the viewing magnification.

Setting up your telescope involves these simple steps:

- Setup your tripod
- Attach the accessory tray
- Attach the mount
- Attach the counterweight shaft and counterweight
- Prepare the mount
- Attach the optical tube to the mount
- Attach the red dot viewfinder
- Attach the eyepiece

Study the picture on the next page(s) and become acquainted with the parts of your telescope. Figure 1A shows a typical reflector telescope whereas Figure 1B shows a refractor. Then proceed to "Setup your Tripod."

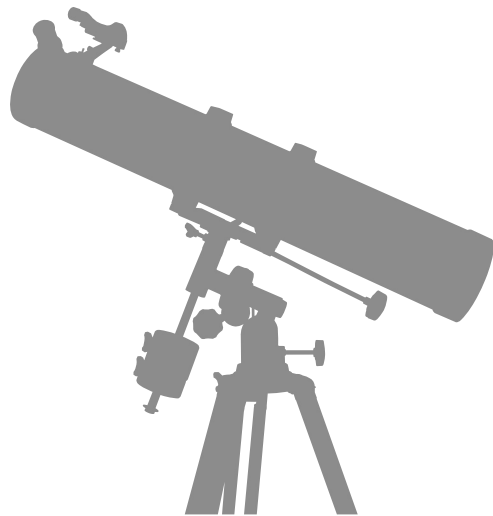

# FIGURE 1A

**Figure 1A:** Meade Polaris Reflecting Telescope

**Inset A:**

Accessory Tray

**Inset B:**

Red Dot Viewfinder Assembly.

**Inset C:**

Tripod Leg

1. Tripod legs
2. Large Equatorial Mount
3. Right Ascension control cable
4. Declination control cable
5. Counterweight(s)
6. Counterweight shaft
7. Counterweight lock knobs
8. Counterweight safety knob
9. Latitude adjustment lock (see Fig. 3)
10. Polar axis (see Fig. 3)
11. Latitude adjustment knob
12. Main optical tube (OTA)
13. Optical tube saddle plate (see Fig. 3)
14. Cradle rings
15. Cradle ring lock knobs
16. Red dot viewfinder bracket mounting thumbscrews (see Fig 4/5)
17. Focuser
18. Focuser thumbscrew
19. Eyepiece
20. Red dot viewfinder On/Off switch (see Inset B)
21. Declination axis (see Fig. 3)
22. Right Ascension lock (see Fig. 3)
23. Declination lock (see Fig. 3)
24. Red dot viewfinder
25. Front dust cover (not shown)
26. Eyepiece holder slots (see Inset A)
27. Right Ascension setting circle
28. Declination setting circle
29. Latitude dial (see Fig. 3)
30. Azimuth lock
31. Focus knobs
32. Azimuth base (see Fig. 3)
33. Accessory tray (see Inset A)
34. Red dot viewfinder alignment screws (see Inset B)
35. Leg brace support (see Inset A)
36. Tripod leg lock knob (see Inset C)
37. Sliding leg extension (see Inset C)
38. OTA saddle plate lock knob(s) (not visible)
39. Primary Mirror collimation adjustments (not visible)
40. Camera adapter mounting screw
41. Secondary Mirror collimation adjustments
42. Optional motor drive gear (Large EQ mount only)



# FIGURE 1B

**Figure 1B:** Meade Polaris Refracting Telescope

**Inset A:**

**Inset B:**

**Inset C:**

Accessory Tray

Red Dot Viewfinder Assembly.

Tripod Leg

1. Tripod legs
2. Small Equatorial Mount
3. Right Ascension control cable
4. Declination control cable
5. Counterweight(s)
6. Counterweight shaft
7. Counterweight lock knobs
8. Counterweight safety knob
9. Latitude adjustment lock (not visible)
10. Polar axis (see Fig. 3)
11. Latitude adjustment knob
12. Main optical tube (OTA)
13. Optical tube saddle plate (see Fig. 3)
14. 90 Degree Erect-Image Prism
15. 90 Degree Prism Thumb screws
16. Red dot viewfinder bracket mounting thumbscrews (see Fig 4/5)
17. Focuser
18. Focuser thumbscrew
19. Eyepiece
20. Red dot viewfinder On/Off switch (see Inset B)
21. Declination axis (see Fig. 3)
22. Right Ascension lock (see Fig. 3)
23. Declination lock (see Fig. 3)
24. Red dot viewfinder
25. Front dust cover (not shown)
26. Eyepiece holder slots (see Inset A)
27. Right Ascension setting circle
28. Declination setting circle
29. Latitude dial (see Fig. 3)
30. Azimuth lock
31. Focus knobs
32. Azimuth base (see Fig. 3)
33. Accessory tray
34. Red dot viewfinder alignment screws (see Inset B)
35. Leg brace support (see Inset A)
36. Tripod leg lock knob (see Inset C)
37. Sliding leg extension (see Inset C)
38. OTA saddle plate lock knob(s) (not visible)
39. Dew Shield

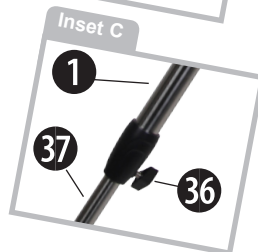
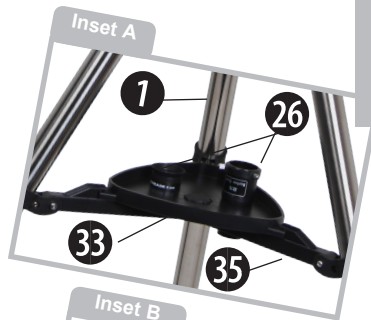

## SETUP YOUR TRIPOD

The tripod is the basic support for your telescope. Its height may be adjusted so that you can view comfortably. Note: Number in brackets, e.g., (3), refer to Fig. 1A and 1B unless noted otherwise. The tripod is shipped from the factory pre-assembled and needs only the mount and accessory tray attached.

1. Spread the tripod legs out evenly apart.
2. Set the height of your tripod:
  - a. Rotate and loosen the tripod leg lock thumbscrew (36) to unlock the sliding leg extension (37).
  - b. Slide the inner portion of the leg (37) in or out to the desired length.
  - c. Rotate and tighten the leg lock thumbscrew (36) to re-lock the inner tripod leg.
  - d. Repeat for the other two legs so when complete, the top of the tripod is level.

## ATTACH THE ACCESSORY TRAY



Fig. 2

The accessory tray attaches at the center of the tripod legs and is a convenient place to hold eyepieces and other Meade accessories while observing, such as the Barlow lens. To attach, place the hole in the center of the accessory tray over the attachment point as shown in Fig 2. Then rotate the tray until the wings of the tray snap into place on the tripod leg brace supports.

To remove the tray, rotate the tray so it unlocks, then remove.

## ATTACH THE MOUNT

Next, attach the mount body (2) to the tripod by placing the base of the mount on top of the tripod. Next, secure the mount to the tripod

using the large azimuth lock knob (30) at the top of the tripod. Tighten to a firm feel.

## ATTACH THE COUNTERWEIGHT SHAFT AND COUNTERWEIGHT

1. Thread the counterweight shaft (6) into the mounts declination axis (21, Fig. 3) until it stops.
2. Remove the safety knob (8) and set aside.
3. Hold the counterweight (5) firmly in one hand and slide the counterweight onto the counterweight shaft (6) so it is about 2" from the bottom of the shaft.
4. Secure in place by tightening the counterweight lock knob (7).
5. Thread the safety nut (8) into the counterweight shaft until tight.

Note: Make sure the safety knob (8) always remains in place on the shaft. This safety feature prevents the counterweight from accidentally falling off the shaft.



Looking at or near the Sun will cause **irreversible** damage to your eye. Do not point this telescope at or near the Sun. Do not look through the telescope as it is moving.

## PREPARE THE MOUNT

1. Attach the flexible cables (3) and (4). These cables are secured in place with a firm tightening of the thumbscrews located at the attachment ends of each cable.
2. Tilt the polar axis of the telescope to roughly a 45° angle with the horizon: Loosen the latitude adjustment lock (9) so you can move the mount to the desired position.
3. Turn the latitude adjusting screw (11) clockwise until the latitude scale (29) on the side of the mount reads approximately 45°.
4. Re-tighten the latitude adjustment lock (9) to secure the mount in place.

## ATTACH THE OPTICAL TUBE TO THE MOUNT

1. Lay the optical tube saddle plate (13) onto the top of the mount as shown in Fig 1.
2. Tighten the optical saddle plate lock knob(s) (38) to a firm feel.

## ATTACH THE RED DOT VIEWFINDER

An eyepiece (19) has a narrow field of view. The red dot viewfinder (24) has a wider field of view, which makes it easier to locate objects. Once the red dot viewfinder is aligned to the optical tube, the red dot can be used to locate and place objects more easily in the telescope's eyepiece.

1. Note the two thumbscrews (16, Fig. 4) thread onto two bolts on the optical tube. Remove the thumbscrews from the tube.
2. Line up the two holes on the red dot viewfinder bracket over the two bolts. Slide the bracket over the bolts with the viewfinder lens facing the front of the telescope.
3. Replace the thumbscrews (16) on to the bolts and tighten to a firm feel.

NOTE: The Polaris 80 and 90 models use a dovetail to secure the red dot viewfinder. For these models, slide the viewfinder bracket into the viewfinder holder and secure with the single knob(s) (38) to a firm feel.

Fig. 3

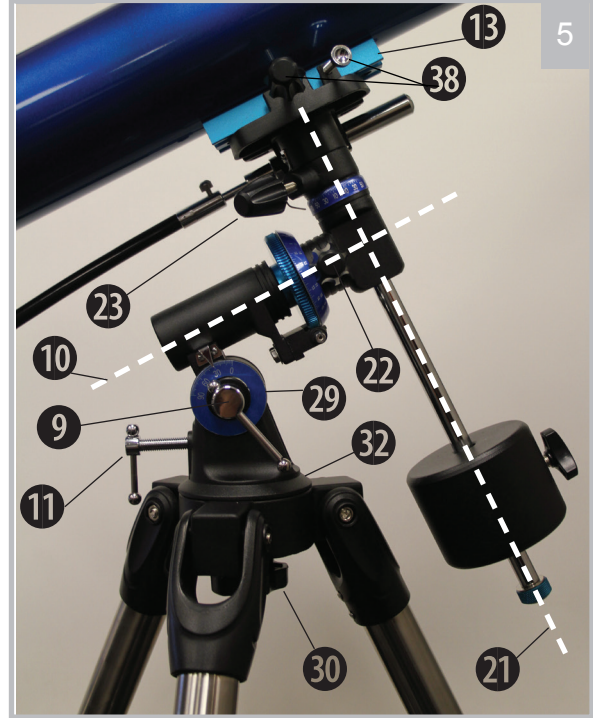

Looking at or near the Sun will cause irreversible damage to your eye. Do not point this telescope at or near the Sun. Do not look through the telescope as it is moving.

locking screw (16, Fig 5).

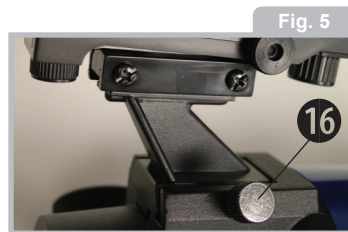
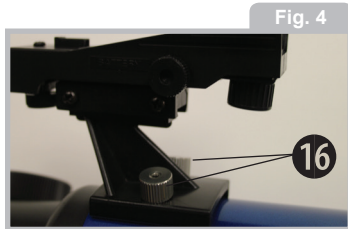

## INSERT THE EYEPIECE

(REFLECTOR MODELS ONLY)

1. Slide the MA25mm eyepiece (19) directly into eyepiece holder on the focuser (17).
2. Tighten the focuser thumbscrew(s) (18)



## SUN WARNING!

**NEVER USE YOUR TELESCOPE TO LOOK AT THE SUN!**

LOOKING AT OR NEAR THE SUN WILL CAUSE INSTANT AND IRREVERSIBLE DAMAGE TO YOUR EYE. EYE DAMAGE IS OFTEN PAINLESS, SO THERE IS NO WARNING TO THE OBSERVER THAT DAMAGE HAS OCCURRED UNTIL IT IS TOO LATE. DO NOT POINT THE TELESCOPE OR ITS VIEWFINDER AT OR NEAR THE SUN. DO NOT LOOK THROUGH THE TELESCOPE OR ITS VIEWFINDER AS IT IS MOVING. CHILDREN SHOULD ALWAYS HAVE ADULT SUPERVISION WHILE OBSERVING.

to hold the eyepiece securely.

(REFRACTOR MODELS ONLY)

1. First, slide the 90 degree erect image prism (14, Fig 1B) directly into the focuser draw tube (17).
2. Tighten the focuser thumbscrew(s) (18) to hold the 90 degree prism securely.

3. Then, slide the MA25mm eyepiece (19) directly into 90 degree erect image prism (14, Fig 1B).

4. Tighten the 90 degree erect image prism thumbscrew (15, Fig 1B) to hold the eyepiece securely.

## BALANCING THE TELESCOPE

In order for the telescope to move smoothly on its mechanical axes, it must first be balanced as follows:

Note: If the counterweight is positioned as recommended previously then the telescope is already approximately balanced.

1. Loosen the right ascension lock (22). The telescope mount will turn freely about the polar axis. Rotate the telescope about the polar axis so that the counterweight shaft (6) is parallel to the ground (horizontal).
2. Loosen the counterweight locking knob (7) and slide the counterweight (5) along the shaft (6) until the telescope remains in any given position without tending to drift up or down around the polar axis (10).

NOTE: Always re-tighten the counterweight



Looking at or near the Sun will cause **irreversible** damage to your eye. Do not point this telescope at or near the Sun. Do not look through the telescope as it is moving.



lock knob (7) before rotating the RA axis to prevent the counterweight from sliding unexpectedly. When the telescope is balanced, proceed to aligning the red dot viewfinder.

### ALIGN THE RED DOT VIEWFINDER

Perform the first part of this procedure during the daytime and the last step at night.

1. Point the telescope at an easy-to-find land object such as the top of a telephone pole or a distant mountain or tower. Look through the eyepiece and turn the focuser knob (31) until the image is sharply focused. Center the object precisely in the eyepiece's field of view.
2. Turn on the red dot viewfinder by turning the on/off switch(20) clockwise.
3. Look through the red dot viewfinder (24). Turn one or more of the viewfinder's alignment screws (34) until the red dot is precisely over the same object as you centered in the eyepiece.
4. Check this alignment at night on a celestial

object, such as the Moon or a bright star, and use the viewfinder's alignment screws to make any necessary refinements.

5. When finished, turn off the red dot viewfinder by rotating the on/off switch(20) counter-clockwise.



Fig. 6

### UNDERSTANDING CELESTIAL MOVEMENTS AND COORDINATES

Understanding where to locate celestial objects and how those objects move across the sky is the key to enjoying the hobby of astronomy. Most amateur astronomers practice “star-hopping” to locate celestial objects. They use star charts or astronomical software to identify bright stars and star patterns as “landmarks” in their search for

astronomical objects. Another technique for locating objects is to use the setting circles that are provided on your telescope.

### UNDERSTANDING HOW CELESTIAL OBJECTS MOVE

Due to the Earth's rotation, celestial bodies appear to move from East to West in a curved path through the skies.

All stars and celestial objects are mapped onto an imaginary sphere surrounding the

### Meade Factoid

Just below the constellation Orion's famous belt of three stars (in the middle of his sword), is The Great Orion Nebula. This wonderful telescope target is really a cosmic star factory where a glowing gas cloud surrounds hot young stars.



Looking at or near the Sun will cause **irreversible** damage to your eye. Do not point this telescope at or near the Sun. Do not look through the telescope as it is moving.

Earth. This mapping system is similar to the system of latitude and longitude on Earth surface maps.

In mapping the surface of the Earth, lines of longitude are drawn between the North and South Poles and lines of latitude are drawn in an East-West direction, parallel to the Earth's equator. Similarly, imaginary lines have been drawn to form a latitude

Fig. 7

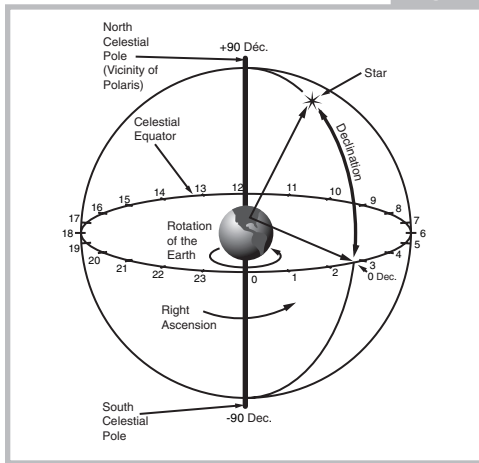

and longitude on the celestial sphere. These lines are known as Right Ascension and Declination.

The celestial map also contains two poles and an equator just like a map of the Earth. The celestial poles are defined as those two points where the Earth's North and South poles, if extended to infinity, would cross the celestial sphere. Thus, the North Celestial Pole is that point in the sky where the North Pole crosses the celestial sphere. The North Star, Polaris, is located very near the North Celestial Pole.

So, just as an object's position on the Earth's surface can be located by its latitude and longitude, celestial objects may also be located using Right Ascension and Declination. For example: You can locate Los Angeles, California, by its latitude ( $+34^\circ$ ) and longitude ( $118^\circ$ ). Similarly, you can locate the Ring Nebula (also known as "M57") by its Right Ascension (18hr) and its Declination ( $+33^\circ$ ).

- **RIGHT ASCENSION (R.A.):** This Celestial version of longitude is measured in units of hours (hr), minutes (min), and seconds (sec)

on a 24 hour "clock" (similar to how Earth's time zones are determined by longitude lines). The "zero" line was chosen to pass through the constellation Pegasus, a sort of cosmic Greenwich meridian. R.A. coordinates range from 0hr 0min 0sec to 23hr 59min 59sec. There are 24 primary lines of R.A., located at 15-degree intervals along the celestial equator. Objects located further and further East of the zero R.A. grid line (0hr 0min 0sec) carry higher R.A. coordinates.

- **Declination (Dec.):** This celestial version of latitude is measured in degrees, arc-minutes, and arc-seconds (e.g.,  $15^\circ 27' 33''$ ). Dec. locations North of the celestial equator are indicated with a plus (+) sign (e.g., the Dec. of the North celestial pole is  $+90^\circ$ ). Any point on the celestial equator (such as the

### THE MEADE 4M COMMUNITY

You haven't just bought a telescope, you have embarked on an astronomy adventure that never ends. Share the journey with others by accepting your free membership in the 4M community of astronomers.

Go to [www.Meade4M.com](http://www.Meade4M.com)  
to activate your membership today.



Looking at or near the **Sun** will cause **irreversible** damage to your eye. Do not point this telescope at or near the Sun. Do not look through the telescope as it is moving.

constellations of Orion, Virgo, and Aquarius) is said to have a Declination of zero, shown as  $0^{\circ} 0' 0''$ .

All celestial objects therefore may be located with their celestial coordinates of Right Ascension and Declination.

### LINING UP WITH THE CELESTIAL POLE

Objects in the sky appear to revolve around the celestial pole. (Actually, celestial objects are essentially “fixed” and their apparent motion is caused by Earth’s rotation). During any 24 hour period, stars make one complete revolution about the pole, circling with the pole at the center. By lining up the telescope’s polar axis with the North Celestial Pole (or for observers located in Earth’s Southern Hemisphere with the South Celestial Pole), astronomical objects may be followed, or “tracked,” by moving the telescope about one axis, the polar axis.

If the telescope is reasonably well aligned with the pole very little use of the telescope’s Declination flexible cable control is necessary. Virtually all of the required telescope tracking

will be in Right Ascension. For the purposes of casual visual telescopic observations, lining up the telescope’s polar axis to within a degree or two of the pole is more than sufficient: with this level of pointing accuracy, the telescope can track accurately by slowly turning the telescope’s R.A. flexible cable control and keep objects in the telescopic field of view for perhaps 20 to 30 minutes.

### POLAR ALIGNMENT OF THE EQUATORIAL MOUNT

To line up the Meade Polaris German

#### TOO MUCH POWER?

Can you ever have too much power? If the type of power you’re referring to is eyepiece magnification, yes you can! The most common mistake of the beginning observer is to “overpower” a telescope by using high magnifications which the telescope’s aperture and atmospheric conditions cannot reasonably support. Keep in mind that a smaller, but bright and well-resolved image is far superior to one that is larger, but dim and poorly resolved. Powers above 400x should be employed only under the steadiest atmospheric conditions.

Fig. 8

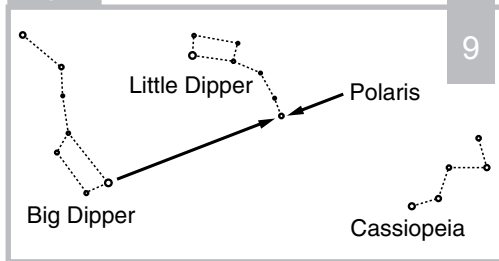

Equatorial mount with the celestial pole, follow this procedure:

1. Slightly loosen the Azimuth lock (30) of the Azimuth base, so that the entire telescope-with-mounting may be rotated in a horizontal direction. Rotate the telescope until it points due North. Use a compass or locate Polaris, the North Star, as an accurate reference to North (See Fig. 8).
2. Level the mount with the horizon, if necessary, by adjusting the heights of the three tripod legs.
3. Determine the latitude of your observing location by checking a road map or atlas. Release the latitude lock (9) and tilt the telescope mount so that the star “Polaris”



Looking at or near the Sun will cause irreversible damage to your eye. Do not point this telescope at or near the Sun. Do not look through the telescope as it is moving.

is centered in the telescope's red dot viewfinder. Then center it in the MA25mm eyepiece. Next, re-tighten the latitude lock.

4. If the above steps (1-3) were performed with reasonable accuracy, your telescope is now sufficiently well-aligned to the North Celestial Pole for visual observations.

Once the mount has been polar-aligned as described above, the latitude angle need not be adjusted again, unless you move to a different geographical location (i.e. a different latitude). The only polar alignment procedure that you need to perform each time you use the telescope is to point the polar axis due North, as described in step 1 above.

## THE MOST IMPORTANT RULE

We have one very important rule that you should always follow when using your telescope: Have Fun!

Have a good time when you're observing. You may not know everything that there is to know about a telescope or what all the sights in the universe are, but that's OK. Just point and observe at first.



Looking at or near the **Sun** will cause **irreversible** damage to your eye. Do not point this telescope at or near the Sun. Do not look through the telescope as it is moving.

You will enjoy your telescope even more as you learn more about it. But don't be scared off by difficult terms or complicated procedures. Don't panic! Just relax and enjoy your scope.

You will begin to grow and learn more about astronomy the more you observe. Go on the internet or to the library and read some books about the stars and planets. Read about astronomers of old. Many of them had telescope no bigger than the one you are using right now. Galileo, who is one of the first astronomers to use a telescope, discovered four of the moons of Jupiter with a telescope about the same size as yours (and his didn't even focus very well!).

## OBSERVING

Observe during the daytime: Try out your telescope during the daytime at first. It is easier to learn how it operates and how to observe when it is light.

Pick out an easy object to observe: A distant mountain, a large tree, a lighthouse or skyscraper make excellent targets. Point the optical tube so it lines up with your object.

In Reflecting telescope models, objects will appear upside down and backwards in this model telescope due to the position of the eyepiece.

Unlock the lock knobs: To move the telescope, you will need to unlock the Right Ascension (22, Fig. 3) and Declination (23, Fig. 3) lock knobs (just rotate to unlock or lock; when locking, only tighten to a "firm feel," do not over tighten).

Use the red dot viewfinder: If you have not done so, align the viewfinder (24) with the telescope's eyepiece (19) as described earlier. Look through the red dot viewfinder until you can see the object. It will be easier to

## Meade Factoid

Jupiter's four brightest moons are easily visible in a telescope. When Galileo Galilei first observed them rotating around Jupiter in 1610, he saw proof that the earth wasn't the center of everything in the universe, as many then supposed.

locate an object using the red dot viewfinder rather than locating with the eyepiece. Line up the object using the viewfinders red dot.

Look through the eyepiece: Once you have the object lined up in the viewfinder, look through the optical tube's eyepiece. If you have aligned your viewfinder, you will see the object in your eyepiece.

Focus: Look through the eyepiece and practice focusing on the object you have chosen.

Try out the slow-motion flexible cable control: Practice using the right ascension control cable (3) and declination control cable (4) to

## Meade Factoid

Saturn's rings of ice, dust and gas are huge and small at the same time. The main rings are so large they could almost reach from the earth to the moon. But they are only about a half of a mile (just a few city blocks) wide.

move the telescope. These can come in very handy, especially when you wish to move the telescope in very small (fine control) steps.

Observe the Moon: When you feel comfortable with the viewfinder, the eyepieces, the locks and the adjustment controls, you will be ready to try out the telescope at night. The Moon is the best object to observe the first time you go out at night. Pick a night when the Moon is a crescent. No shadows are seen during a full Moon, making it appear flat and uninteresting.

Look for different features on the Moon. The most obvious features are craters. In fact you can see craters within craters. Some craters have bright lines about them. These are called rays and are the result of material thrown out of the crater when it was struck by a colliding object. The dark areas on the Moon are called maria and are composed of lava from the period when the Moon still had volcanic activity. You can also see mountain ranges and fault lines on the Moon.

Use a neutral density filter (often called a "moon filter") when observing the Moon. Neutral density filters are available from

Fig. 9



Meade as an optional accessory and enhance contrast to improve your observation of lunar features.

Spend several nights observing the Moon. Some nights, the Moon is so bright that it makes other objects in the sky difficult to see. These are nights that are excellent for lunar observation.

Observe the Solar System: After observing the Moon, you are ready to step up to the next level of observation, the planets.

There are four planets that you can easily observe in your telescope: Venus, Mars, Jupiter and Saturn.

Nine planets (maybe more!) travel in a fairly

circular pattern around our Sun. Any system of planets orbiting one or more stars is called a solar system. Our Sun, by the way, is a single, yellow dwarf star. It is average as far as stars go and is a middle aged star.

Beyond the planets are clouds of comets, icy planetoids and other debris left over from the birth of our sun. Recently astronomers have found large objects in this area and they may increase the number of planets in our solar system.

The four planets closest to the Sun are rocky and are called the inner planets. Mercury, Venus, Earth and Mars comprise the inner planets. Venus and Mars can be easily seen in your telescope.

Venus is seen before dawn or after sunset, because it is close to the Sun. You can observe Venus going through crescent phases. But you cannot see any surface detail on Venus because it has a very thick atmosphere of gas.

When Mars is close to the Earth, you can see some details on Mars, and sometimes even Mars' polar caps. But quite often, Mars

is further away and just appears as a red dot with some dark lines crisscrossing it.

Jupiter, Saturn, Uranus, Neptune and Pluto comprise the outer planets. These planets, except for Pluto, are made mostly of gases and are sometimes called gas giants. If they had grown much bigger, they may have become stars. Pluto is made mostly of ice.

Jupiter is quite interesting to observe. You can see bands across the face of Jupiter. The more time you spend observing these bands, the more details you will be able to see.

One of the most fascinating sights of Jupiter are its moons. The four largest moons are called the Galilean moons, after the astronomer Galileo, who observed them for the first time. If you've never watched the Galilean moons in your telescope before, you're missing a real treat! Each night, the moons appear in different positions around the Jovian sky. This is sometimes called the Galilean dance. On any given night, you might be able to see the shadow of a moon on the face of Jupiter, see one moon eclipse another or even see a moon emerge from behind Jupiter's giant disk. Drawing

the positions of the moons each night is an excellent exercise for novice astronomers.

Any small telescope can see the four Galilean moons of Jupiter (Fig. 9), plus a few others, but how many moons does Jupiter actually have? No one knows for sure! Nor are we sure how many Saturn has either. At last count, Jupiter had over 60 moons, and held a small lead over Saturn. Most of these moons are very small and can only be seen with very large telescopes.

Probably the most memorable sight you will see in your telescope is Saturn. Although

#### SURF THE WEB

- The Meade 4M Community:  
<http://www.meade4m.com>
- Sky & Telescope:  
<http://www.skyandtelescope.com>
- Astronomy:  
<http://www.astronomy.com>
- Astronomy Picture of the Day:  
<http://antwrp.gsfc.nasa.gov/apod>
- Photographic Atlas of the Moon:  
[http://www.lpi.ursa.edu/research/lunar\\_orbiter](http://www.lpi.ursa.edu/research/lunar_orbiter)
- Hubble Space Telescope Public Pictures:  
<http://oposite.stsci.edu/pubinfo/pictures.html>



Looking at or near the **Sun** will cause **irreversible** damage to your eye. Do not point this telescope at or near the Sun. Do not look through the telescope as it is moving.

you may not see many features on the surface of Saturn, its ring structure will steal your breath away. You will probably be able to see a black opening in the rings, known as the Cassini band.

Saturn is not the only planet that has rings, but it is the only set of rings that can be seen with a small telescope. Jupiter's rings cannot be seen from Earth at all—the Voyager spacecraft discovered the ring after it passed Jupiter and looked back at it. It turns out, only with the sunlight shining through them, can the rings be seen. Uranus and Neptune also have faint rings.

Optional color filters help bring out detail and contrast of the planets. Meade offers a line of inexpensive color filters.

**What's Next?** Beyond the Solar System: Once you have observed our own system of planets, it's time to really travel far from home and look at stars and other objects.

You can observe thousands of stars with your telescope. At first, you may think stars are just pinpoints of light and aren't very interesting. But look again. There is much

information that is revealed in stars.

The first thing you will notice is that not all stars are the same colors. See if you can find blue, orange, yellow, white and red stars. The color of stars sometimes can tell you about the age of a star and the temperature that they burn at.

Other stars to look for are multiple stars. Very often, you can find double (or binary) stars, stars that are very close together. These stars orbit each other. What do you notice about these stars? Are they different colors? Does one seem brighter than the other?

Almost all the stars you can see in the sky are part of our galaxy. A galaxy is a large grouping of stars, containing millions or even billions of stars. Some galaxies form a spiral (like our galaxy, the Milky Way) and other galaxies look more like a large football and are called elliptical galaxies. There are many galaxies that are irregularly shaped and are thought to have been pulled apart because they passed too close to—or even through—a larger galaxy.

You may be able to see the Andromeda

galaxy and several others in your telescope. They will appear as small, fuzzy clouds. Only very large telescope will reveal spiral or elliptical details.

You will also be able to see some nebulas with your scope. Nebula means cloud. Most nebulas are clouds of gas. The two easiest to see in the Northern Hemisphere are the Orion nebula during the winter and the Triffid nebula during the summer. These are large clouds of gas in which new stars are being born. Some nebulas are the remains of stars exploding. These explosions are called supernovas.

Fig. 10



Looking at or near the **Sun** will cause **irreversible** damage to your eye. Do not point this telescope at or near the Sun. Do not look through the telescope as it is moving.

When you become an advanced observer you can look for other types of objects such as asteroids, planetary nebula and globular clusters.

And if you're lucky, every so often a bright comet appears in the sky, presenting an unforgettable sight.

The more you learn about objects in the sky, the more you will learn to appreciate the sights you see in your telescope. Start a notebook and write down the observations you make each night. Note the time and the date.

Use a compass to make a circle, or trace around the lid of a jar. Draw what you see in your eyepiece inside the circle. The best exercise for drawing is to observe the moons of Jupiter every night or so. Try to make Jupiter and the moons approximately the same size as they look in your eyepiece. You will see that the moons are in a different position every night. As you get better at drawing, try more challenging sights, like a crater system on the moon or even a nebula.

Go your library or check out the internet for more information about astronomy. Learn about the basics: light years, orbits, star

colors, how stars and planets are formed, red shift, the big bang, what are the different kinds of nebula, what are comets, asteroids and meteors and what is a black hole. The more you learn about astronomy, the more fun, and the more rewarding your telescope will become.

### SOME OBSERVING TIPS

**Eyepieces:** Always begin your observations using the 25mm low-power eyepiece. The 25mm eyepiece delivers a bright, wide field of view and is the best to use for most viewing conditions. Use the high-power 9mm eyepiece to view details when observing the Moon and planets. If the image become fuzzy, switch back down to a lower power. Changing eyepieces changes the power or magnification of your telescope.

By the way, users of reflecting telescopes may have noticed something strange when looking through your eyepiece. The image is upside down and reversed. That means reading words can be a problem. But it has no affect on astronomical objects.

**Optional Accessory Barlow lens:** You can also change magnification by using a Barlow lens. The Barlow lens doubles the power of your telescope (See Fig. 10).

Meade offers a complete line of eyepieces for your telescope. Most astronomers have four or five low-power and high power eyepieces to view different objects and to cope with different viewing conditions.

**Objects move in the eyepiece:** If you are observing an astronomical object (the Moon, a planet, star, etc.) you will notice that the object will begin to move slowly through the telescopic field of view. This

#### STAR CHARTS

Star charts and planispheres are useful for a variety of reasons. In particular, they are a great aid in planning a night of celestial viewing.

A wide variety of star charts are available in books, in magazines, on the internet and on CD Roms. Meade offers AutoStar Suite™ software. Contact your local Meade dealer or Meade's Customer Service department for more information.

Astronomy and Sky and Telescope magazines print star charts each month for up-to-the-minute maps of the heavens.



Looking at or near the **Sun** will cause **irreversible** damage to your eye. Do not point this telescope at or near the Sun. Do not look through the telescope as it is moving.



movement is caused by the rotation of the Earth and makes an object move through the telescope's field of view. To keep astronomical objects centered in the field, simply move the telescope on one or both of its axes—vertically and/or horizontally as needed—try using the telescopes coarse and fine adjustment controls. At higher powers, astronomical objects will seem to move through the field of view of the eyepiece more rapidly.

Place the object to be viewed at the edge of the field and, without touching the telescope, watch it drift through the field to the other side before repositioning the telescope so

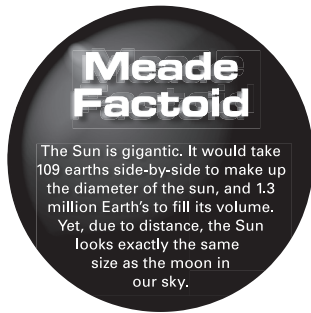

that the object to be viewed is again placed at the edge of the field, ready to be further observed.

**Vibrations:** Avoid touching the eyepiece while observing through the telescope. Vibrations resulting from such contact will cause the image to move. Avoid observing sites where vibrations cause image movement (for example, near railroad tracks). Viewing from the upper floors of a building may also cause image movement.

Let your eyes “dark-adapt:” Allow five or ten minutes for your eyes to become “dark adapted” before observing. Use a red-filtered flashlight to protect your night vision when reading star maps, or inspecting the telescope. Stay away from bright lights too. Do not use a regular flash-light or turn on other lights when observing with a group of other astronomers. You can make your own red filtered flashlight by taping red cellophane over a flashlight lens.

**Viewing through windows:** Avoid setting up the telescope inside a room and observing through an opened or closed window pane. Images may appear blurred or distorted

due to temperature differences between inside and outside air. Also, it is a good idea to allow your telescope to reach the ambient (surrounding) outside temperature before starting an observing session.

**When to observe:** Planets and other objects viewed low on the horizon often lack sharpness—the same object, when observed higher in the sky, will appear sharper and have greater contrast. Try reducing power (change your eyepiece) if your image is fuzzy or shimmers. Keep in mind that a bright, clear, but smaller image is more interesting than a larger, dimmer, fuzzy one. Using too

#### JOIN AN ASTRONOMY CLUB, ATTEND A STAR PARTY

One of the best ways to increase your knowledge of astronomy is to join an astronomy club. Check your local newspaper, school, library, or telescope dealer/store to find out if there's a club in your area.

Many groups also hold regularly scheduled Star Parties at which you can check out and observe with many different telescopes and other pieces of astronomical equipment. Magazines such as *Sky and Telescope* and *Astronomy* print schedules for many popular Star Parties around the United States and Canada.



Looking at or near the **Sun** will cause **irreversible** damage to your eye. Do not point this telescope at or near the Sun. Do not look through the telescope as it is moving.

high a power eyepiece is one of the most common mistakes made by new astronomers.

**Dress Warm:** Even on summer nights, the air can feel cool or cold as the night wears on. It is important to dress warm or to have a sweater, jacket, gloves, etc., nearby.

**Know your observing site:** If possible, know the location where you will be observing. Pay attention to holes in the ground and other obstacles. Is it a location where wild animals, such as skunks, snakes, etc., may appear? Are there viewing obstructions such as tall trees, street lights, headlights and so forth?

#### ASTRONOMY RESOURCES

- The Meade 4M Community  
27 Hubble, Irvine, CA 92618
- Astronomical League  
Executive Secretary  
5675 Real del Norte, Las Cruces, NM 88012
- The Astronomical Society of the Pacific  
390 Ashton Ave., San Francisco, CA 94112
- The Planetary Society  
65 North Catalina Ave, Pasadena, CA 91106
- International Dark-Sky Association, Inc.  
3225 N. First Avenue, Tucson, AZ 85719-2103

The best locations are dark locations, the darker the better. Deep space objects are easiest to see under dark skies. But it is still possible to observe even in a city.

Surf the Web and visit your local library: The internet contains a huge amount of astronomical information, both for children and adults. Check out astronomy books from your library. Look for star charts—these are available on a monthly basis in *Astronomy and Sky* and *Telescope* magazines.

HAVE A GOOD TIME,  
ASTRONOMY IS FUN!

#### SPECIFICATIONS

##### POLARIS 70

Optical tube design.....Refractor  
Optical tube focal length.....900mm  
Objective lens diameter.....70mm (2.8")  
Focal ratio.....f/12.9  
Mount.....Small German Equatorial

##### POLARIS 80

Optical tube design.....Refractor  
Optical tube focal length.....900mm  
Objective lens diameter.....80mm (3.1")  
Focal ratio.....f/11.3  
Mount.....Small German Equatorial

##### POLARIS 90

Optical tube design.....Refractor  
Optical tube focal length.....900mm  
Objective lens diameter.....90mm (3.5")  
Focal ratio.....f/10  
Mount.....Large German Equatorial

##### POLARIS 114

Optical tube design.....Reflector  
Optical tube focal length.....900mm  
Primary mirror diameter.....114mm (4.5")  
Focal ratio.....f/7.9  
Mount.....Large German Equatorial



Looking at or near the **Sun** will cause **irreversible** damage to your eye. Do not point this telescope at or near the Sun. Do not look through the telescope as it is moving.

**POLARIS 127**

Optical tube design.....	Reflector
Optical tube focal length.....	1000mm
Primary mirror diameter.....	127mm (5.0")
Focal ratio.....	f/7.9
Mount.....	Large German Equatorial

**POLARIS 130**

Optical tube design.....	Reflector
Optical tube focal length.....	650mm
Primary mirror diameter.....	130mm (5.1")
Focal ratio.....	f/5
Mount.....	Large German Equatorial

What do the specifications mean?

Optical tube focal length is simply a measurement of the length of the optical tube. In other words, this is the distance light travels in the telescope before being brought to focus in you eyepiece. For example, the Polaris 90 Refractor tube is 900mm long.

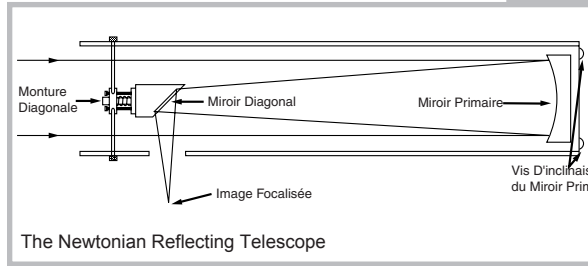

Fig. 11

Primary mirror diameter (reflectors) or Objective lens diameter (refractors) is how big the mirror or lens is on your scope. Telescopes are always described by how large their primary mirror/lens is. For example, the objective lens on the Polaris 90 is 90mm or 3.5 inches. Telescopes come in many different sizes. They can be 70mm, 8 inches, 16 inches, or even 3 feet in diameter. The Hubble Space Telescope's primary mirror has a diameter of 2.4 meters (that's 7.8 feet across!).

The focal ratio helps determine

how fast the photographic speed of a telescope is. The lower the focal ratio number, the faster the exposure. F/5 is faster than f/10. The slower the focal ratio, the longer the exposure time is needed when a camera is hooked up to the telescope. For example, the Polaris 90 Refractor has slow focal ratio at f/10. Sometimes, astronomers use focal reducers to make slow exposure telescopes have faster focal ratios.

**USE THE SPECIFICATIONS TO CALCULATE THE MAGNIFICATION OF YOUR EYEPIECE**

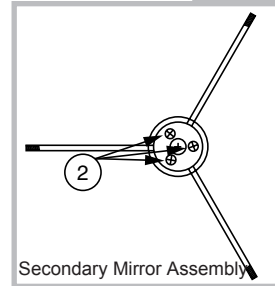

Fig. 12

The power of a telescope is how much it magnifies objects. Each telescope has its own set of focal lengths and, therefore, different magnifications when used with various eyepieces. For example, the Polaris 90 used with the 25mm eyepiece magnifies an object 36 times. The 9mm eyepiece used with the Polaris 90 will magnify



Looking at or near the Sun will cause irreversible damage to your eye. Do not point this telescope at or near the Sun. Do not look through the telescope as it is moving.

objects 100 times.

You can calculate how much magnification an eyepiece will have with your specific telescope. Just divide the telescope focal length by the focal length of the eyepiece.

Focal Length of the Telescope

÷

Focal Length of the Eyepiece

=

Magnification

Look at the specifications. For example, you will see that the focal length of the Polaris 90 is 900mm. Let's say that you have obtained a 6.3mm eyepiece. You can tell what the focal length of your eyepiece is as it is always printed on the side of the eyepiece. Divide: 900mm ÷ 6.3mm, which equals 142.86. Round this off to the nearest whole number and you find the 6.3mm eyepiece used with the Polaris 90 magnifies objects 143 times.

If you use a Barlow lens with one of your eyepieces, it doubles the magnification of your eyepiece. Other types of Barlows

can triple or further increase the power of an eyepiece. To find out how much your magnification is when you use a 2x Barlow, multiply your eyepiece's magnification by two.

For example, the 25mm low-power eyepiece used with the Polaris 90 magnifies an object 36 times. Multiply 36 by 2 and you get 72 times magnification with a Barlow.

Eyepiece's magnification x 2

=

Magnification with a 2X Barlow lens

It's worth repeating: Keep in mind that a bright, clear, but smaller image is more interesting than a larger, dimmer, fuzzy one. Using too high a power eyepiece is one of the most common mistakes made by new astronomers. So don't think that higher magnification is necessarily better—quite often the best view is with lower magnification value!

## TAKING CARE OF YOUR TELESCOPE

Your telescope is a precision optical instrument designed for a lifetime of rewarding viewing.

It will rarely, if ever, require factory servicing or maintenance. Follow these guidelines to keep your telescope in the best condition:

- As with any quality instrument, lens or mirror surfaces should be cleaned as infrequently as possible. Front surface aluminized mirrors (reflecting models), in particular, should be cleaned only when absolutely necessary. In all cases avoid touching any mirror surface. A little dust on the surface of a mirror or lens causes negligible loss of performance and should not be considered reason to clean the surface. When lens or mirror cleaning does become necessary, use a camel's hair brush or compressed air gently to remove dust. If the telescope's dust cover is replaced after each observing session, cleaning of the optics will rarely be required.

- Fingerprints and organic materials on the lens or mirror may be removed with a solution of 3 parts distilled water to 1 part isopropyl alcohol. You may also add 1 drop of biodegradable dishwashing soap per pint of solution. Use soft, white facial tissues and make short, gentle strokes. Change tissues often.

**CAUTION:** Do not use scented or lotioned



Looking at or near the Sun will cause irreversible damage to your eye. Do not point this telescope at or near the Sun. Do not look through the telescope as it is moving.

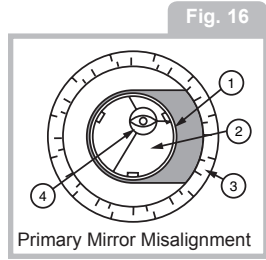
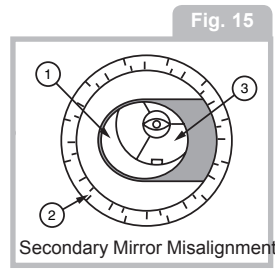
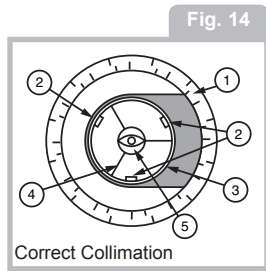
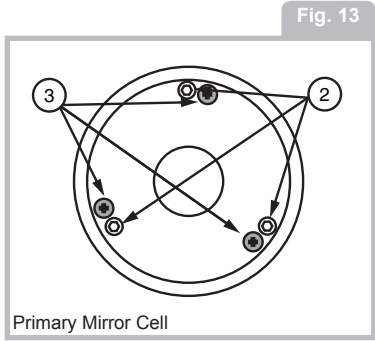

tissues or damage could result to the optics. DO NOT use a commercial photographic lens cleaner.

**COLLIMATION (ALIGNMENT) OF OPTICS (REFLECTING MODELS ONLY)**

All Meade Polaris Reflecting telescopes are optically aligned at the factory prior to shipment. It is unlikely that you will need to align, or collimate, the optics after receipt of the instrument. However, if the telescope received unusually rough handling in

shipment, it is possible that the optics must be re aligned for best optical performance. In any case this alignment procedure is simple, and requires only a few minutes the very first time the telescope is used. Take the time to familiarize yourself with the following collimation procedure, so that

you will recognize a properly collimated instrument and can adjust the collimation yourself, if necessary.

**A. CORRECT COLLIMATION**

The properly collimated (aligned) mirror system in the Meade Polaris telescope assures the sharpest images possible. This occurs when the primary mirror and secondary mirror are tilted so that the focused image falls directly through the center of the focuser draw tube. These mirror tilt adjustments are made with the secondary mirror assembly and the primary mirror cell (Fig. 13) and will be discussed later.

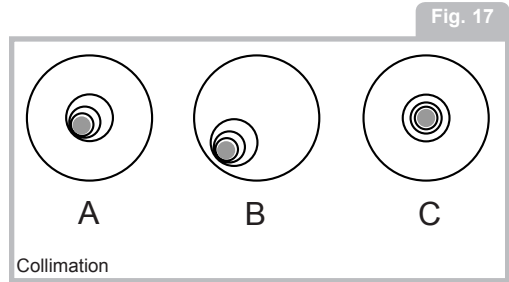

To inspect the view of the mirror collimation, look down the focuser draw tube with the eyepiece removed. The edge of the focuser drawtube (1, Fig. 14), will frame the reflections of the primary mirror with the 3 mirror clips (2, Fig. 14), the secondary mirror (3, Fig. 14), the spider vanes (4, Fig. 14), and your eye (5, Fig. 14). Properly aligned, all of these reflections will appear concentric (i.e., centered) as illustrated in Fig. 14.

Any deviation from the concentric reflections will require adjustments to the secondary mirror assembly and/or the primary mirror cell (Fig. 12).

## B. SECONDARY MIRROR HOLDER ADJUSTMENTS

If the secondary mirror (1, Fig. 15) is centered in the draw tube (2, Fig. 15), but the primary mirror is only partially visible in the reflection (3, Fig. 15), one or more of the 3 Phillips-head secondary mirror collimation screws need adjusting. First, unthread each of the secondary mirror collimation screws slightly to the point of where you can tilt the secondary holder from side-to-side. By



Looking at or near the **Sun** will cause **irreversible** damage to your eye. Do not point this telescope at or near the Sun. Do not look through the telescope as it is moving.

grasping the secondary holder with your hand, tilt the secondary mirror holder until you see the primary mirror become as centered in the reflection of the diagonal mirror as possible. Once you are at the best position, thread in the 3 Phillips-head secondary mirror collimation screws to lock the holder in place. Then, if necessary, make adjustments to these 3 Phillips-head screws to refine the tilt-angle of the secondary mirror until the entire primary mirror can be seen centered within the secondary mirror reflection. When the secondary mirror is correctly aligned, it will look like Fig. 16 (Note: The primary mirror is shown out of alignment).

### C. PRIMARY MIRROR ADJUSTMENTS

If the secondary mirror (1, Fig. 16) and the reflection of the primary mirror (2, Fig. 16) appear centered within the draw tube (3, Fig. 16), but the reflection of your eye and the reflection of the secondary mirror (4, Fig. 16) appear off center, you will need to adjust the primary mirror tilt screws of the primary mirror cell (2, Fig. 13). These primary tilt screws are located behind the primary mirror, at the

lower end of the main tube.

To adjust the primary mirror tilt screws (2, Fig. 13), first turn by several turns, the primary mirror cell lock knobs (3, Fig. 13) that are next to each primary mirror tilt screw. The three primary mirror cell locking screws are Phillips head screws on all Polaris models.

Then by trial-and-error, turn the primary mirror tilt knobs (2, Fig. 13) until you develop a feel for which way to turn each knob to center the reflection of your eye. Once centered, as in Fig. 14, turn the 3 primary mirror cell locking screws (3, Fig. 13) to re-lock the tilt-angle adjustment.

NOTE: Some models have large thumb knobs for the primary mirror cell tilt knobs(2, Fig 13). Other models have Phillips head screws as the primary mirror cell tilt screws. On these models, the primary mirror cell tilt screws (2, Fig 13) are the screws that have the screw heads touching the rear cell.

### D. STAR TESTING THE COLLIMATION

With the collimation performed, you will want to test the accuracy of the alignment on a star. Use the 25mm eyepiece and point the telescope at a moderately bright (second or

third magnitude) star, then center the star image in the telescope's field-of-view. With the star centered follow the method below:

- Bring the star image slowly out of focus until one or more rings are visible around the central disc. If the collimation was performed correctly, the central star disk and rings will be concentric circles, with a dark spot dead center within the out-of-focus star disk (this is the shadow of the secondary mirror), as shown in Fig. 17C. (An improperly aligned telescope will reveal elongated circles (Fig. 17A), with an off-center dark shadow.)
- If the out-of-focus star disk appears elongated (Fig. 17A), you will need to adjust the primary mirror adjusting tilt screws of the primary mirror cell (3, Fig. 13)
- To adjust the primary mirror tilt screws (3, Fig. 13), first unscrew several turns the 3 hex-head primary mirror cell locking screws (2, Fig. 13), to allow free turning movement of the tilt knobs.
- Using the flexible cable controls move the telescope until the star image is at the edge of the field-of-view in the eyepiece, as in Fig.



Looking at or near the Sun will cause **irreversible** damage to your eye. Do not point this telescope at or near the Sun. Do not look through the telescope as it is moving.

17B.

•As you make adjustments to the primary mirror tilt screws (3, Fig. 13), you will notice that the out-of-focus star disk image will move across the eyepiece field. Choose one of the 3 primary mirror tilt screws and slightly move the shadow to the center of the disk. Then slightly move the telescope using the flexible cable controls to center the star disk image in the center of the eyepiece.

- If any further adjustments are necessary, repeat this process as many times as needed until the out-of-focus star disk appears as in Fig. 18C, when the star disk image is in the center of the eyepiece field.
- With the star testing of the collimation complete, tighten the 3 hex-head primary mirror locking screws (2, Fig. 13)

### CHANGING THE VIEWFINDER BATTERY

If the viewfinder red dot does not illuminate, verify the viewfinder is on by rotating the knob below the viewfinder lens clockwise. If the red dot does not illuminate, the battery may need replacing.



To replace the battery, press the left side of the viewfinder housing labeled “push”. The battery compartment will slide out on the right side of the viewfinder (see Fig. 18). Replace the battery with a Lithium CR2032 battery with the positive side up. Then push the battery compartment back into the viewfinder and power on.

### OPTIONAL ACCESSORIES

Additional Eyepieces (1.25” barrel diameter only): For higher or lower viewing magnifications, Meade’s Series 4000 Super Plössl eyepieces, available in a wide variety of sizes, provide a high level of image resolution and color correction at an economical price. Contact your Meade Dealer or see the Meade catalog for more information. Visit us on the web at [www.meade.com](http://www.meade.com).



Looking at or near the Sun will cause **irreversible** damage to your eye. Do not point this telescope at or near the Sun. Do not look through the telescope as it is moving.



## MEADE CONSUMER SOLUTIONS

If you have a question concerning your telescope, call Meade Instruments Consumer Solutions Department at (800) 626-3233. Consumer Solutions Department hours are 7:00AM to 5:00PM, Pacific Time, Monday through Friday. Call the Meade Consumer Solutions Department first, before returning the telescope to the factory, giving full particulars as to the nature of the problem, as well as your name, address, and daytime telephone number. The great majority of servicing issues can be resolved by telephone, avoiding return of the telescope to the factory.

## MEADE LIMITED WARRANTY

Every Meade telescope, and telescope accessory is warranted by Meade Instruments Corp. ("Meade") to be free of defects in materials and workmanship for a period of ONE YEAR from the date of original purchase in the U.S.A. Meade will repair or replace a product, or part thereof, found by Meade to be defective, provided the defective part is returned to Meade, freight-prepaid, with proof of purchase. This warranty applies to the original purchaser only and is non-

transferable. Meade products purchased outside North America are not included in this warranty, but are covered under separate warranties issued by Meade international distributors.

**RGA Number Required:** Prior to the return of any product or part, a Return Goods Authorization (RGA) number must be obtained from Meade by writing, or by calling (800) 626-3233. Each returned part or product must include a written statement detailing the nature of the claimed defect, as well as the owner's name, address, and phone number.

This warranty is not valid in cases where the product has been abused or mishandled, where unauthorized repairs have been attempted or performed, or where depreciation of the product is due to normal wear-and-tear. Meade specifically disclaims special, indirect, or consequential damages or lost profit which may result from a breach of this warranty. Any implied warranties which cannot be disclaimed are hereby limited to a term of one year from the date of original retail purchase.

This warranty gives you specific rights. You

may have other rights which vary from state to state.

Meade reserves the right to change product specifications or to discontinue products without notice.

This warranty supersedes all previous Meade product warranties.

©2014 MEADE INSTRUMENTS CORP.



Looking at or near the Sun will cause **irreversible** damage to your eye. Do not point this telescope at or near the Sun. Do not look through the telescope as it is moving.

## OBSERVATION LOG

OBSERVER: \_\_\_\_\_

OBJECT NAME: \_\_\_\_\_

DATE & TIME OBSERVED: \_\_\_\_\_

CONSTELLATION: \_\_\_\_\_

EYEPIECE SIZE: \_\_\_\_\_

SEEING CONDITIONS:    EXCELLENT    GOOD    POOR

NOTES: \_\_\_\_\_

\_\_\_\_\_

\_\_\_\_\_

\_\_\_\_\_



\_\_\_\_\_

\_\_\_\_\_

\_\_\_\_\_

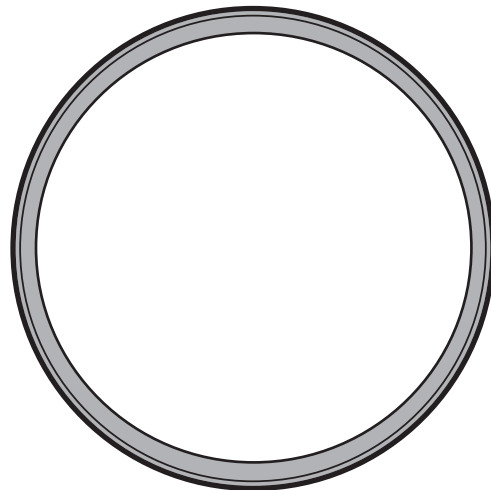

DRAWING OF IMAGE

## OBSERVATION LOG

OBSERVER: \_\_\_\_\_

OBJECT NAME: \_\_\_\_\_

DATE & TIME OBSERVED: \_\_\_\_\_

CONSTELLATION: \_\_\_\_\_

EYEPIECE SIZE: \_\_\_\_\_

SEEING CONDITIONS:    EXCELLENT    GOOD    POOR

NOTES: \_\_\_\_\_

\_\_\_\_\_

\_\_\_\_\_

\_\_\_\_\_



\_\_\_\_\_

\_\_\_\_\_

\_\_\_\_\_

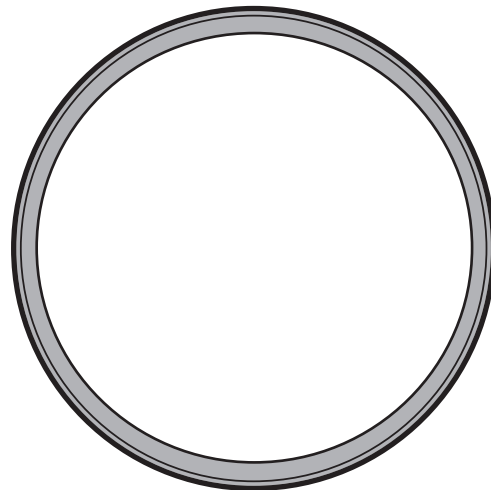

DRAWING OF IMAGE

1-800

626-3233

Meade Instruments Corp.  
27 Hubble, Irvine,  
California

926 18

[www.meade.com](http://www.meade.com)

