

**Кухонный набор POINT 120**  
**(Kitchen POINT 120)**

Код ТН ВЭД ЕАЭС

9403 40 100 0  
9403 90 300 0

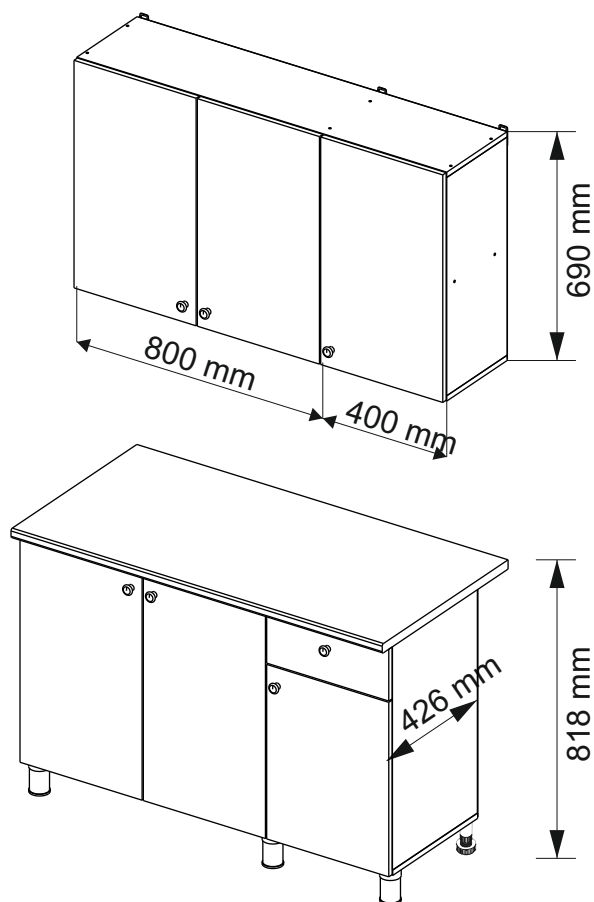

|      |             |             |
|------|-------------|-------------|
|      |             |             |
| 1200 | 690/<br>818 | 306/<br>600 |

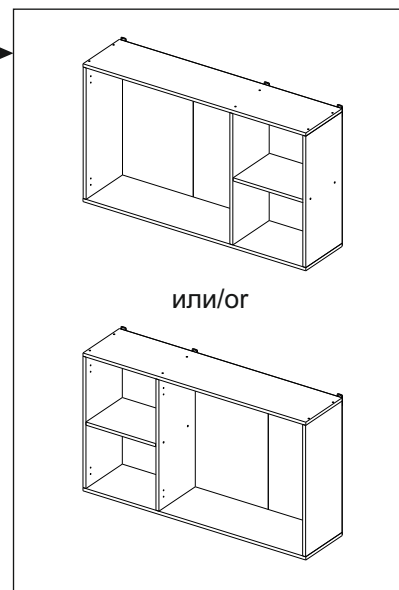

White - Белый

Комплектовочная ведомость / Set package sheet

| Упак/<br>Package | Наименование  | Description                  | Цвет детали/<br>Décor          | Размер /<br>Size, mm | Кол-во/<br>Quantit | №  |
|------------------|---------------|------------------------------|--------------------------------|----------------------|--------------------|----|
| 1                | Фурнитура     | Furniture/Cabinetry hardware | -                              | -                    | -                  | -  |
| 2                | Столешница    | Worktop                      | Antares                        | 1200x600             | 1                  | 12 |
|                  | Крышка        | Top                          | White                          | 1200x405             | 1                  | 8  |
|                  | Деталь ящика  | Side drawers                 | White                          | 100x400              | 2                  | 10 |
|                  | Деталь ящика  | Side drawers                 | White                          | 100x318              | 1                  | 11 |
|                  | Бок правый/ср | Side right/middle            | White                          | 658x286              | 2                  | 5  |
|                  | Вязка         | Connecting element           | White                          | 382x286              | 1                  | 7  |
|                  | Вязка         | Connecting element           | White                          | 775x405              | 1                  | 6  |
|                  | Крышка        | Top                          | White                          | 1200x286             | 2                  | 9  |
| 3                | Бок правый    | Side right                   | White                          | 674x405              | 1                  | 3  |
|                  | Бок левый     | Side left                    | White                          | 658x286              | 1                  | 4  |
|                  | Соед элемент  | Connecting back element      | -                              | 656 mm               | 2                  | 17 |
|                  | Бок левый     | Side left                    | White                          | 674x405              | 1                  | 1  |
|                  | Бок средний   | Side middle                  | White                          | 674x405              | 1                  | 2  |
| 4                | Панель        | Drawer panel                 | см упак/look at<br>the package | 156x396              | 1                  | 13 |
|                  | Створка       | Door                         |                                | 526x396              | 1                  | 14 |
|                  | Створка       | Door                         |                                | 686x396              | 5                  | 15 |
|                  | ХДФ           | Back element                 | White                          | 686x404              | 1                  | 18 |
|                  | ХДФ           | Back element                 | White                          | 686x396              | 5                  | 19 |
|                  | ХДФ           | Back element                 | White                          | 350x407              | 1                  | 20 |

(PL) Instrukcja montażu

(CZ) Návod k montáži

(D) Montageanleitung

(GB) Assembly instruction

(F) Model d'emploi

(HU) Szerelési útmutató

(I) Istruzione di montaggio

(NL) Handleiding voor de montage



(RU) Инструкция по монтажу

(RO) Instrucțiuni de montare

(SK) Návod k montáži

(TR) Montaj talimatı

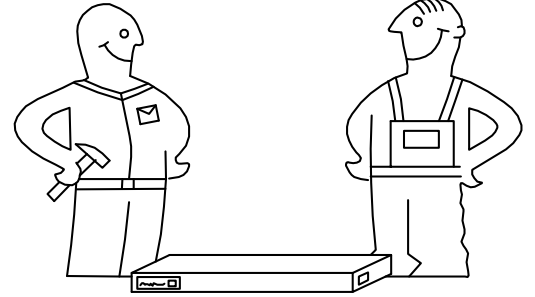
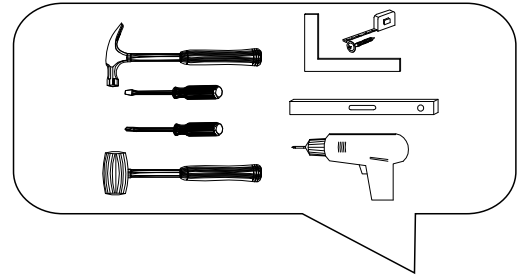



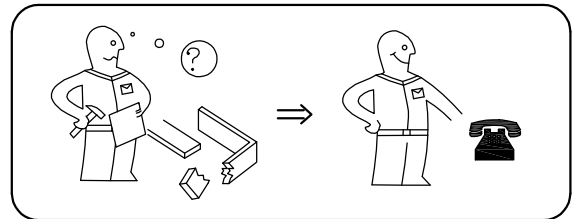
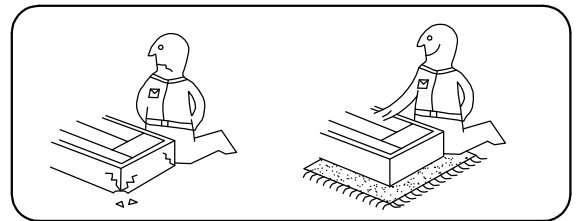



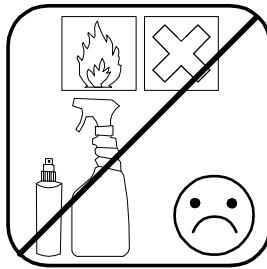
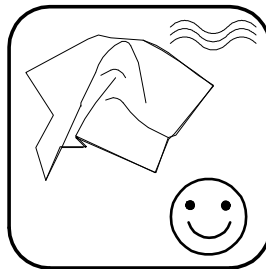
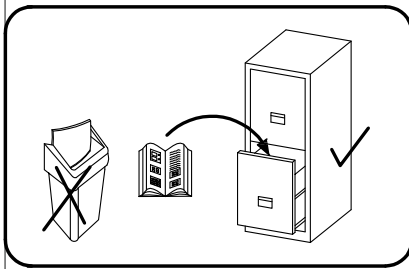

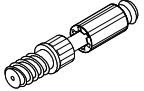

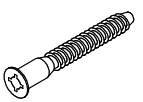

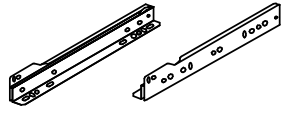
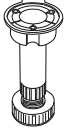
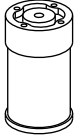

| ⚠ Uwaga • Upozornění • Achtung • Attention • Caution • Figyelem ⚠<br>Attenzione • Opgelet • Внимание • Atenție • Upozornenie • Dikkat |  |
|---|--|
| PL  | Czyszczenie należy wykonać wyłącznie za pomocą ściereczki lub lekko nawilżonego ręcznika. Nie stosować środków czyszczących do szorowania.         |
| CZ  | Čistění je nutné vykonávat výhradně pomocí utěrky nebo lehce navlhčeného ručníku. Nepoužívejte čističe obsahující abrazivní částice.               |
| D   | Bitte nur mit einem Staubtuch oder leicht feuchtem Lappen reinigen. Keine scheuernden Putzmittel verwenden.  |
| GB  | Please only clean with a duster or a damp cloth. Do not use any abrasive cleaners.   |
| F   | Le nettoyage se fait uniquement à l'aide d'un torchon ou d'une serviette légèrement mouillée.  |
| HU  | A tisztítás kizárólag törülköh vagy enyhén nedvesített törölköző segítségével végezhető. Súroló hatású tisztítószerket nem szabad használni.       |
| I   | Pulire esclusivamente con un panno o un asciugamano umido.   |
| NL  | Reinig alleen met een stofdoek of een lichtjes vochtige doek. Gebruik geen schurende poetsmiddelen.  |
| RU  | Очищайте от пыли тряпкой или слегка влажной ветошью. Не допускается применение чистящих средств, не предназначенных для ухода за мебелью.          |
| RO  | Curățarea trebuie efectuată numai cu o cârpă sau cu un prosop ușor umezit. Nu utilizați agenți de curățare abrazivi.                               |
| SK  | Čistení je nutné vykonávať výhradne pomocí utierky alebo ľahko zvlhnutým ručníkom. Nepoužívajte čistiace prostriedky obsahujúce abrazívne častice. |
| TR  | Lütfen sadece bir toz bezilye veya hafif nemli yumuşak bir bezle siliniz. Aşındırıcı temizlik malzemeleri kullanmayınız.                           |

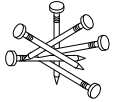

**Karta serwisowa • Servisní list • Service Karte • Service card • Carte de service • Szervizkártya  
Scheda di servizio • Service kaart • Сервисная карта • Fisa service • Servisný list • Servis karti**

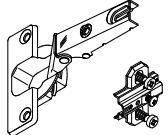
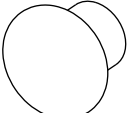
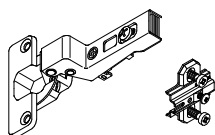

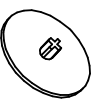
|  |         |  |        |  |         |   |          |  |        |
|--|---------|--|--------|--|---------|---|----------|--|--------|
| 1  |         | 2  |        | 5  | 7x50    | 6   | 6,3x10,5 | 10   | 3,5x25 |
|   |         |   |        |   |         |    |          |   |        |
| 8 x  |         | 8 x  |        | 28 x   |         | 28 x  |          | 12 x   |        |
| 15   |         | 18   | 3,5x15 | 24   | 400 mm  | 35  | 100 mm   | 59   | 100 mm |
|   |         |   |        |   |         |    |          |   |        |
| 1 x  |         | 60 x   |        | 1 x  |         | 3 x   |          | 3 x  |        |
| 45   |         | 48   |        | 53   |         | 71  | ∅ 5 mm   | 72   |        |
|   |         |   |        |   |         |    |          |   |        |
| 8 x  |         | 50 x   |        | 3 x  |         | 2 x   |          | 22 x   |        |
| 91   | Hinge A | 125  | K1     | 92   | Hinge B | 3   |          | 73   |        |
|  |         |  |        |  |         |  |          |  |        |
| 10x  |         | 7 x  |        | 2 x  |         | 3 x   |          | 8 x  |        |

