

WV 1

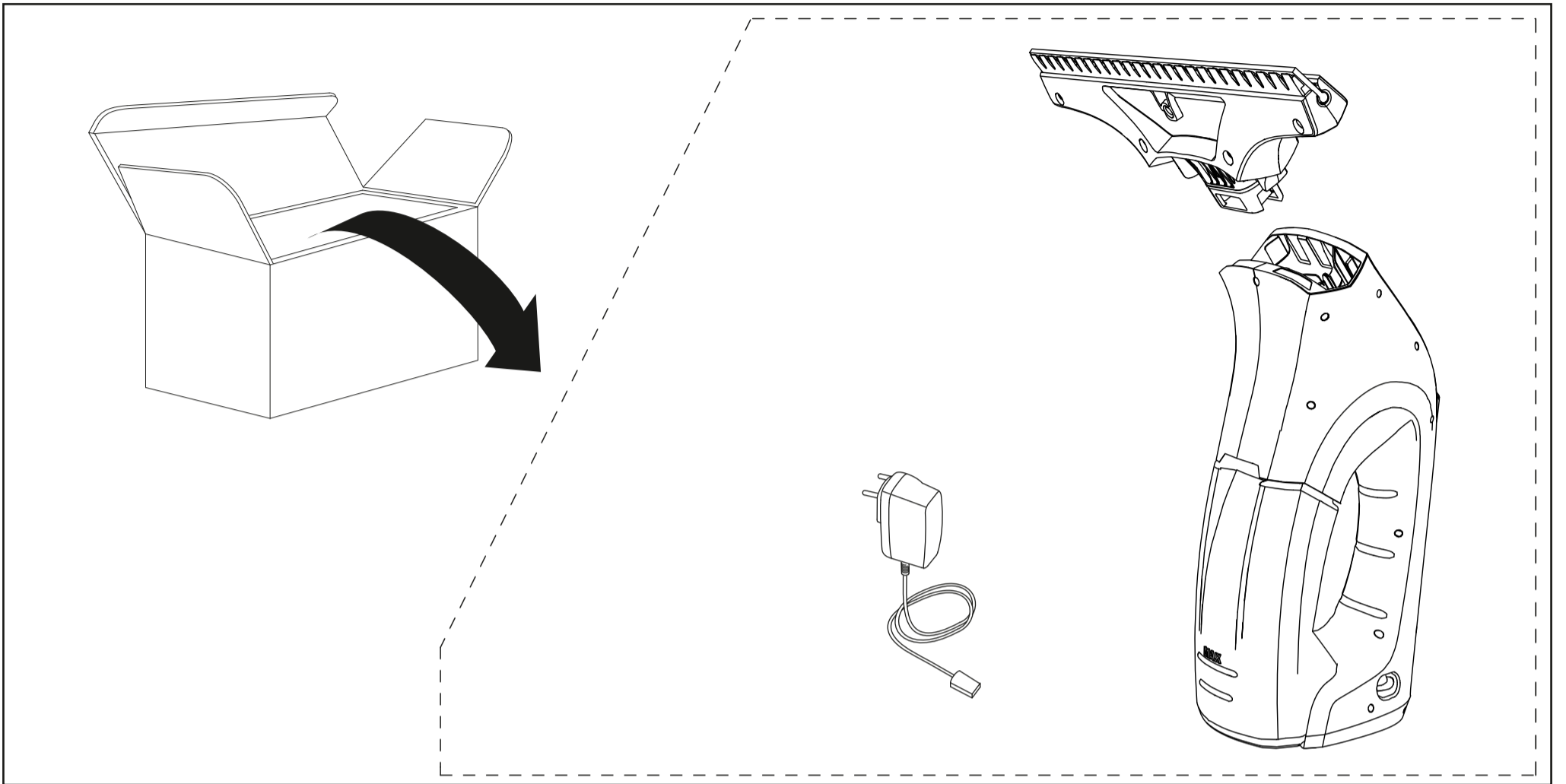

<p>Li-Ion</p>	<p>3,65 V</p>		<p>IPX4</p>		<p>0,5 kg</p>				
<p>nom</p>	<p>10 W</p>		<p>100 ml</p>		<p>185 min</p>				
	<table border="1"> <tr> <td>V</td> <td>5,5</td> </tr> <tr> <td>mA</td> <td>600</td> </tr> </table>	V	5,5	mA	600		<p>51 db(A)</p>		<p>20 min</p>
V	5,5								
mA	600								

