

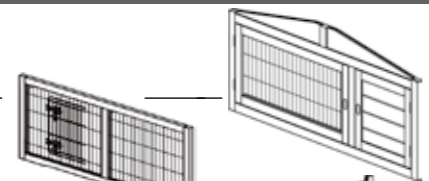

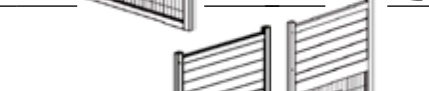









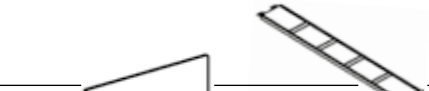



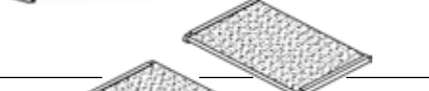
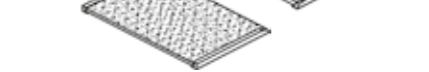

Pos.	Beschreibung Description	Maße Measurement	Anzahl Quantity	Art.-Nr. Item
1	Vorderteil inkl. Tür, oben Front parts with door, top	 1110 x 470 x 25 mm	1	62321-10
2	Vorderteil, unten Front part, bottom	 1110 x 450 x 25 mm	1	62321-11
3	Seitenteil, links Left side panel	 900 x 665 x 25 mm	1	62321-30
4	Seitenteil, rechts Right side panel	 900 x 665 x 25 mm	1	62321-31
5	Rückwand, oben Back wall, top	 1160 x 620 x 12 mm	1	62321-20
6	Rückwand, unten Back wall, bottom	 1160 x 460 x 12 mm	1	62321-21
7	Hintere Bodenplatte Rear hatch	 1105 x 180 x 25 mm	1	62321-42
8	Rampe Ramp	 960 x 145 x 20 mm	1	62321-41
9	Trennwand Partition	 605 x 400 x 8 mm	1	62321-32
10	Ausziehbare Bodenwanne Drawer with plastic inlay	 1105 x 480 x 55 mm	1	62321-40
11	Dachfirst Roof ridge	 790 x 90 x 60 mm	1	62321-52
12	Dachhälfte, links Roof part, left	 755 x 620 x 50 mm	1	62321-50
13	Dachhälfte, rechts Roof part, right	 755 x 620 x 50 mm	1	62321-51

Pos.	Beschreibung Description	Größe Size	Anzahl Quantity	Art.-Nr. Item
A	Senkkopfschraube Countersunk screw	 ø 3,5 x 50 mm	12+1	62321-60
B	Senkkopfschraube Countersunk screw	 ø 3,5 x 30 mm	8+1	
C	Senkkopfschraube Countersunk screw	 ø 3 x 16 mm	2+1	
D	Senkkopfschraube Countersunk screw	 ø 3,5 x 22 mm	4+1	
E	Fangband, links/rechts Check strap, left/right	 plus je 8 Schrauben F plus 8 screws F for each	280 mm	1/1
F	Senkkopfschraube Countersunk screw	 ø 3 x 14 mm	16+1	6235-56
G	Verschlussriegel Locking bolt	 plus 1 Schraube H plus 1 screw H	70 mm	
H	Senkkopfschraube Counterstunk screw	 ø 3 x 25 mm	1	6235-51
I	Verriegelungsherz Lock heart-shaped	 ø 55 mm	1	

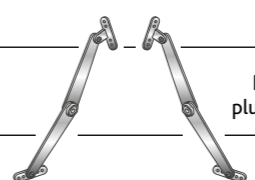
Weitere bereits vormontierte Teile (als Ersatzteile separat erhältlich)
Other parts already assembled (spare parts separately available)

Beschreibung Description	Größe Size	Anzahl Quantity	Art.-Nr. Item
Scharnier, breit, für Klapptür Hinge, wide, for flap door	38 mm	2	6235-71
Scharnier für Tür oder Dach Hinge for door or roof	50 mm	10	6235-72

(DE) Sie finden eine französische und italienische Anleitung unter der jeweiligen Artikel-Nummer auf www.trixie.de.
 (EN) Please find instructions in French and Italian under the corresponding item number at www.trixie.de.
 (FR) Vous trouverez les informations détaillées en français et en italien à chaque référence d'article, sur notre site www.trixie.fr.
 (IT) Le istruzioni in italiano e francese sono disponibili selezionando il codice dell'articolo sul nostro sito www.trixie.it.

- DE Verschrauben Sie das linke und rechte Seitenteil (3/4) mit dem oberen und unteren Vorderteil (1/2).
- EN Screw the left and right side panel (3/4) with the upper and lower front parts (1/2).

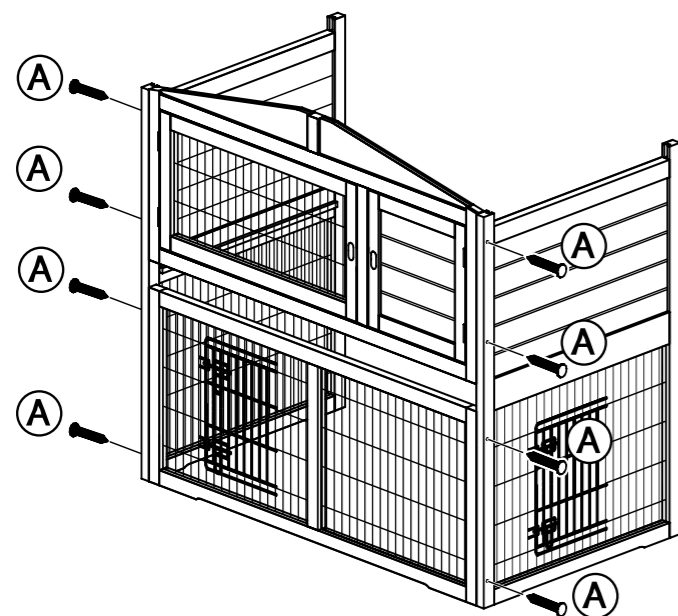

1.

- DE Verschrauben Sie nun die beiden Teile der Rückwand (5/6) mit den Seitenteilen (3/4).
- EN Screw both back walls (5/6) with the side panels (3/4).

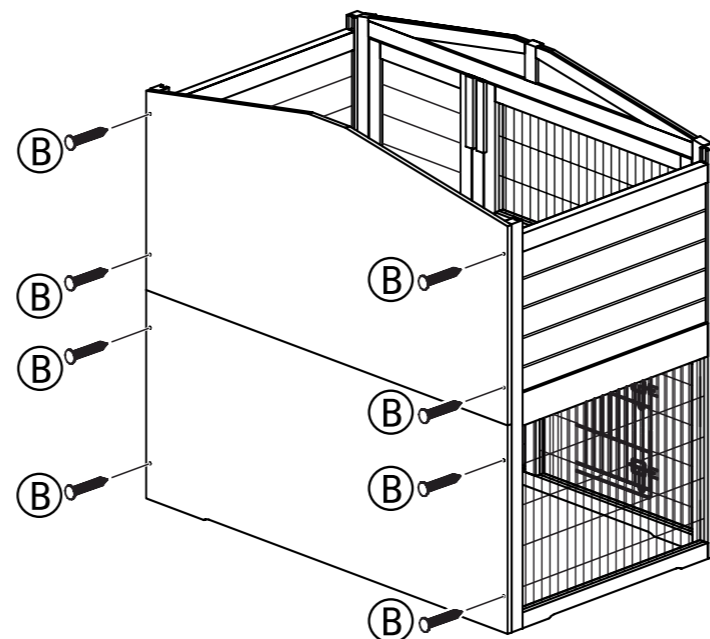

2.

- DE Legen Sie die hintere Bodenplatte (7) ein, schieben Sie die Rampe (8) durch die kleine Öffnung des Bodens und schrauben Sie diese fest.
- EN Insert the rear hatch (7), put the ramp (8) through the small opening and tighten it.

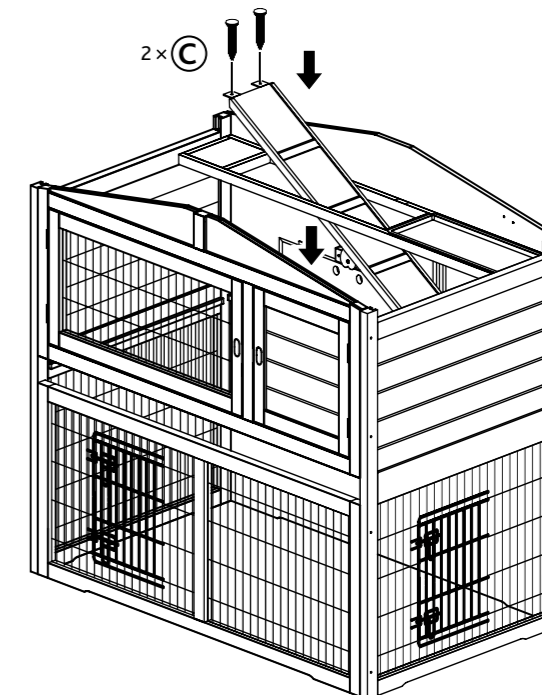

3.

- DE Befestigen Sie das Verriegelungsherz (I) an der oberen Rückwand. Schieben Sie die Trennwand (9) und die ausziehbare Bodenwanne (10) ein.
- EN Fasten the heart-shaped lock (I) on the upper back wall. Insert the partition (9) and the drawer (10).

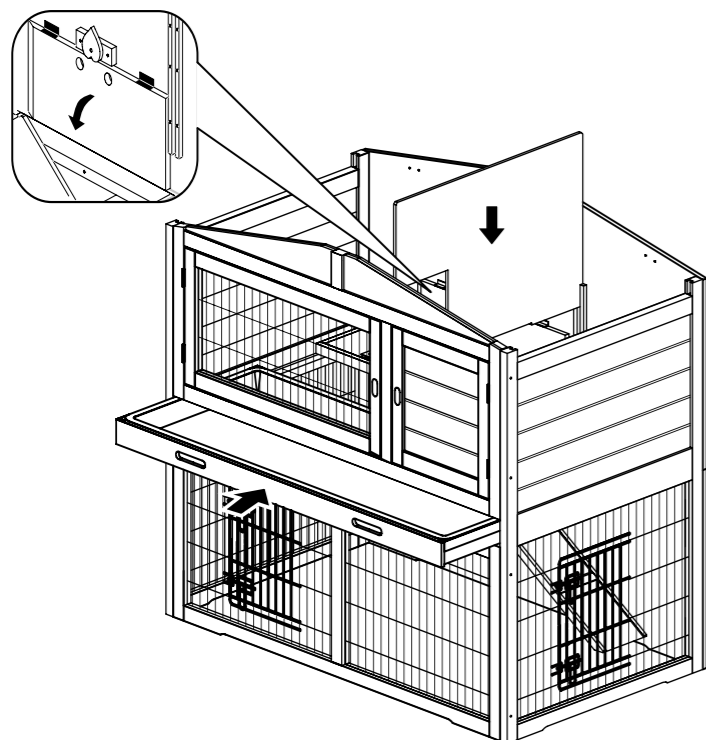

4.

- DE Befestigen Sie die beiden Dachhälften (12/13). Verschrauben Sie die beiden Fangbänder (E) jeweils an den Innenseiten der Dachhälften und der Rückwand. Befestigen Sie den Dachfirst (11) an einer der Dachhälften.
- EN Fix the two parts of the roof (12/13). Screw the check straps (E) to each inner side of the roof parts and the back wall. Fix the ridge (11) to one side of the roof.

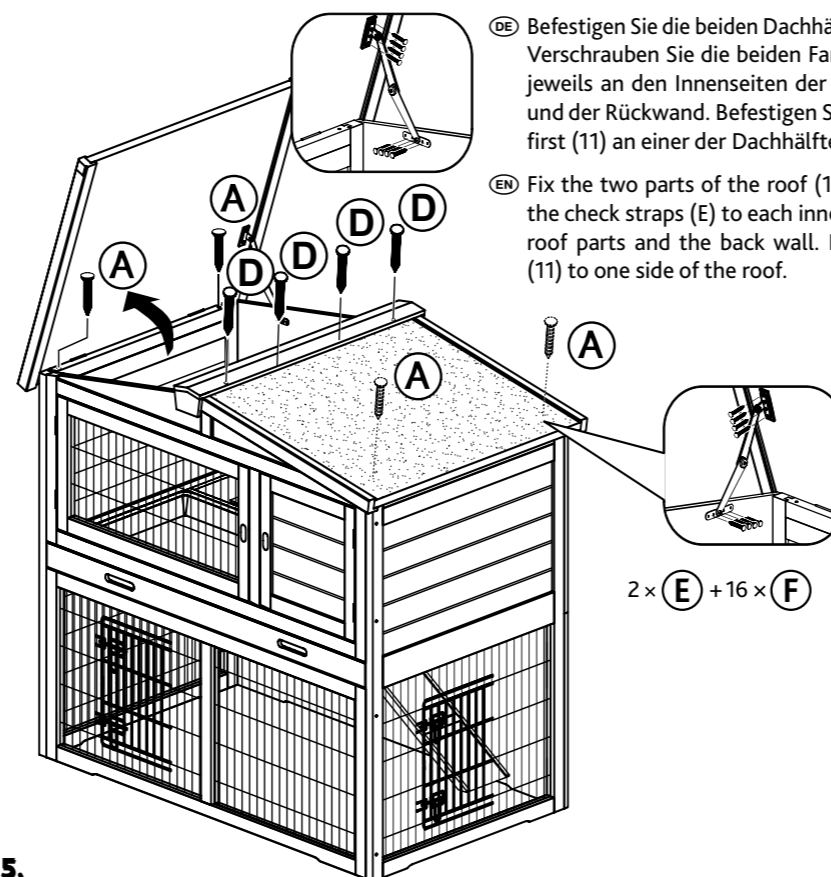

5.

- DE Abschließend schrauben Sie den Verschlussriegel (G) zwischen die Türen.
- EN Screw the locking bolt (G) between the doors.

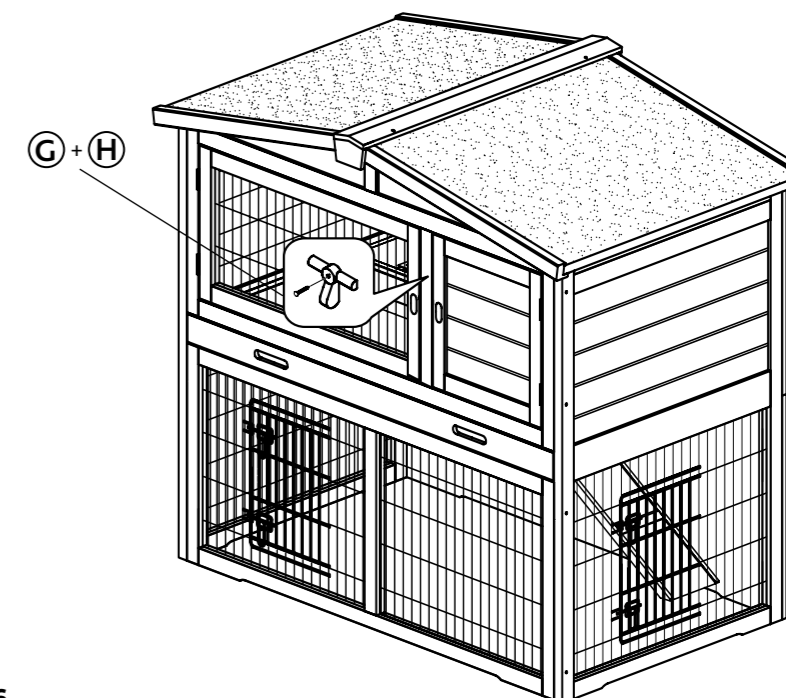

6.