

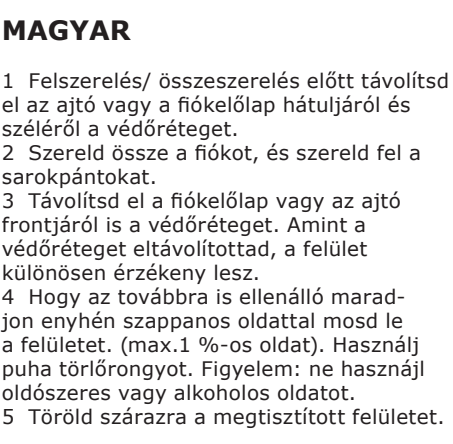

1 Fjarlægið hlífðarfilmuna af brún hurðarinnar eða skúffuframhliðarinnar fyrir samsetningu/uppsetningu.
2 Setjið skúffuna saman og festið laminar.
3 Fjarlægið hlífðarfilmuna af framhlið hurðarinnar eða skúffuframhliðarinnar. Strax og hlífðarfilman hefur verið fjarlægð er yfirboðið sérstaklega viðkvæmt fyrir rísþum.
4 Hægt er að auka viðnám yfirborðsins með því að herða það. Þvíð yfirborðið með mjúkum klút og mildri sápulausn (1% að hámarki). Athugið! Notið ekki hreinsiefni sem innihalda alkóhól eða svarfefni.
5 Þurrkið yfirborðið með mjúkum klút.

Fyrir dagleg þrif, sjá lið 4.



A napi tisztítással kapcsolatos tudnivalókat a 4. pontban találod.

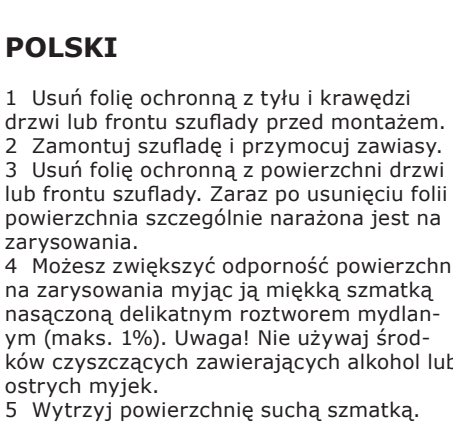
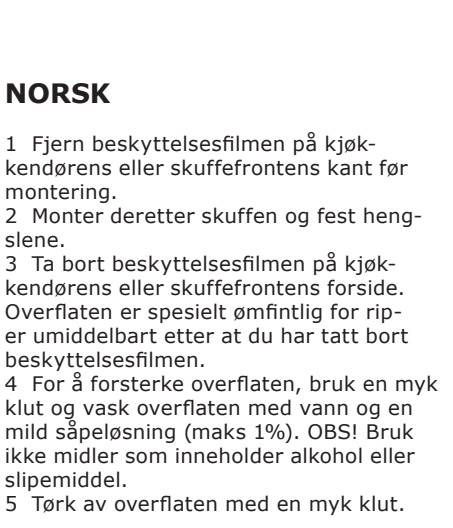
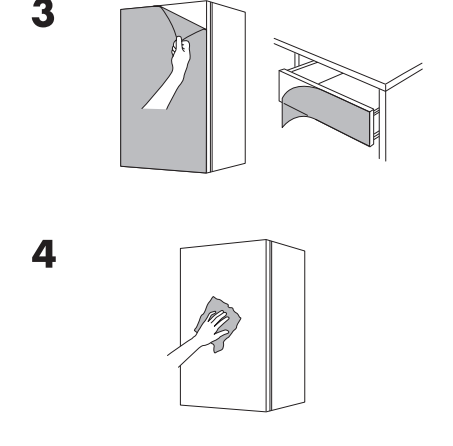
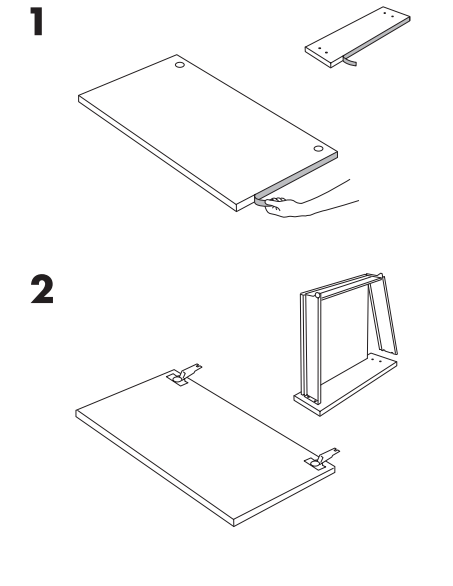

Codziennie czyszczenie - patrz punkt 4.

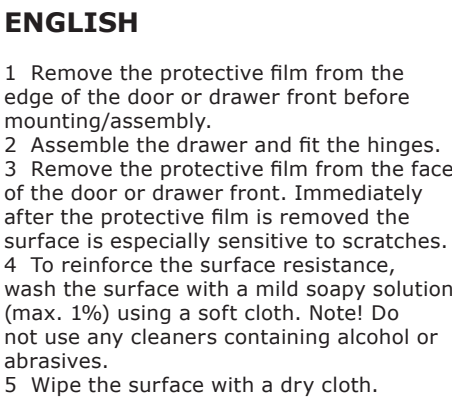

For daily cleaning, see point 4.

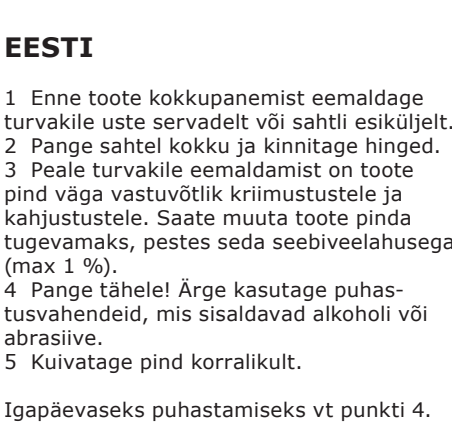
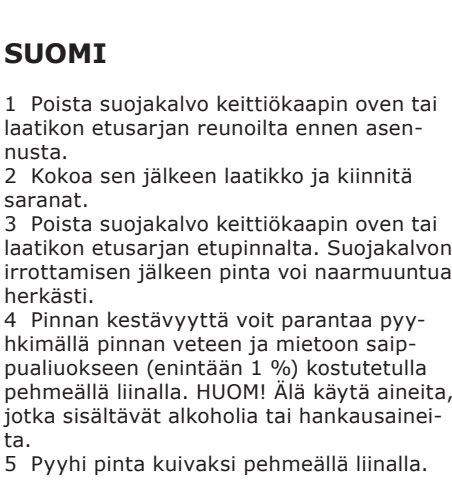

Igapäevaseks puhastamiseks vt punkti 4.

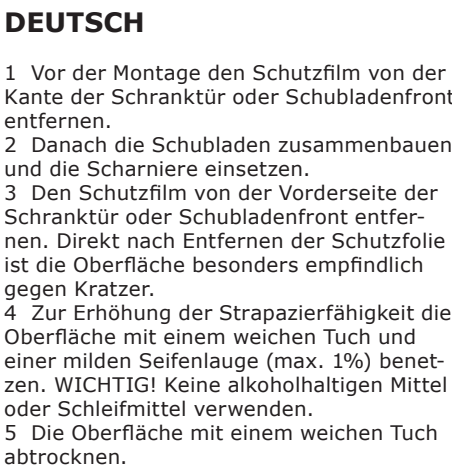

Zur täglichen Pflege bitte Punkt 4 beachten.

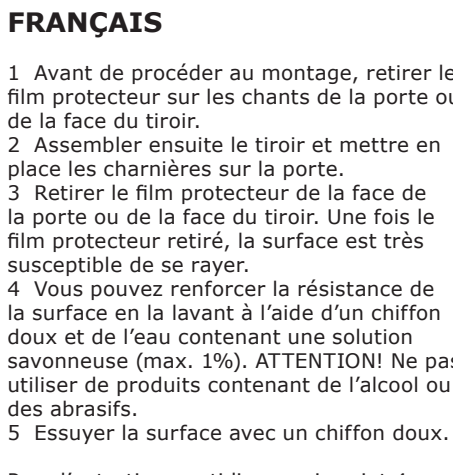
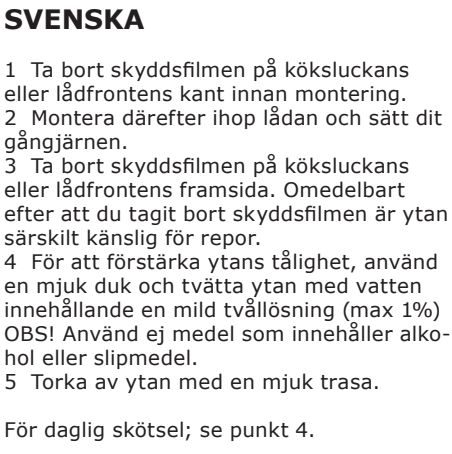

Pour l’entretien quotidien : voir point 4.

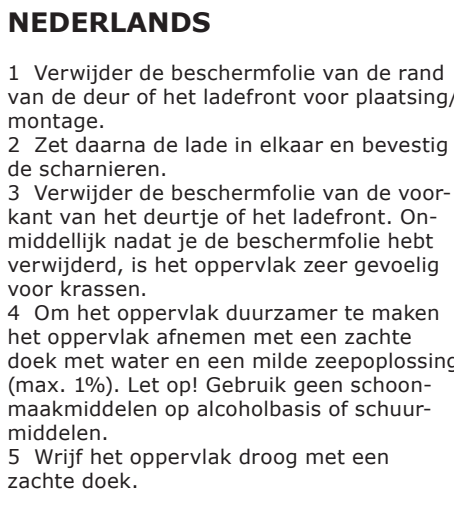
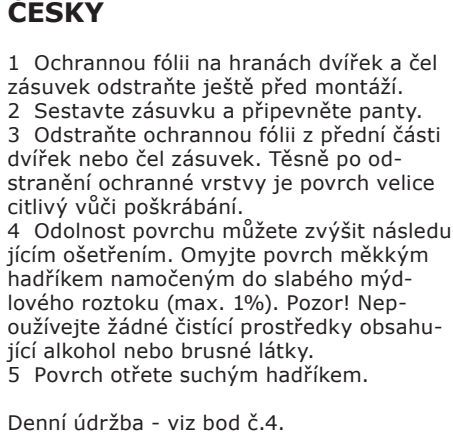

Zie voor dagelijks reinigen punt 4.

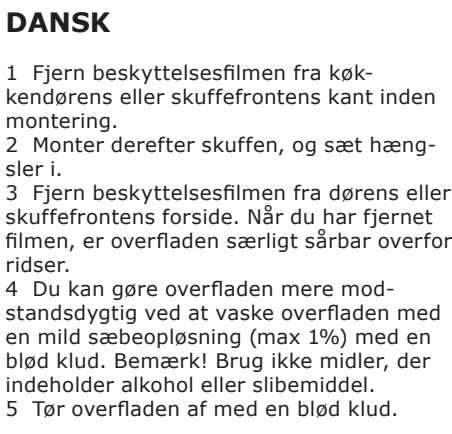
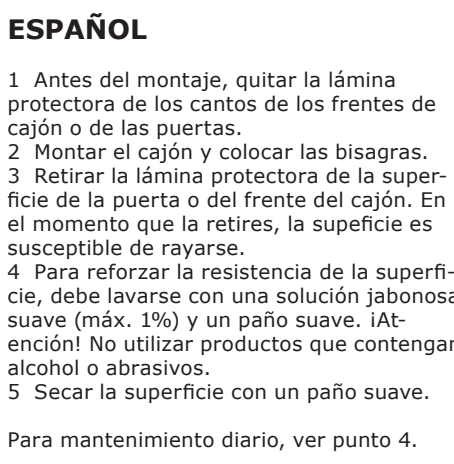

Daglig vedligeholdelse, se punkt 4.



ÍSLENSKA

1 Fjarlægið hlífðarfilmuna af brún hurðarinnar eða skúffuframhliðarinnar fyrir samsetningu/uppsetningu.
2 Setjið skúffuna saman og festið laminar.
3 Fjarlægið hlífðarfilmuna af framhlið hurðarinnar eða skúffuframhliðarinnar. Strax og hlífðarfilman hefur verið fjarlægð er yfirboðið sérstaklega viðkvæmt fyrir rísþum.
4 Hægt er að auka viðnám yfirborðsins með því að herða það. Þvíð yfirborðið með mjúkum klút og mildri sápulausn (1% að hámarki). Athugið! Notið ekki hreinsiefni sem innihalda alkóhól eða svarfefni.
5 Þurrkið yfirborðið með mjúkum klút.

Fyrir dagleg þrif, sjá lið 4.

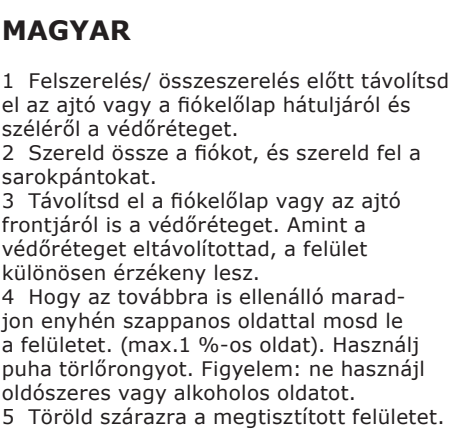

A napi tisztítással kapcsolatos tudnivalókat a 4. pontban találod.



For daily cleaning, see point 4.

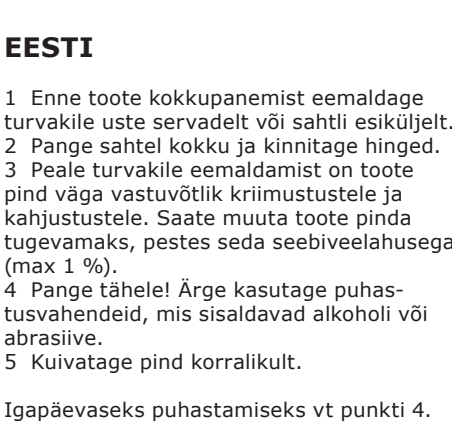
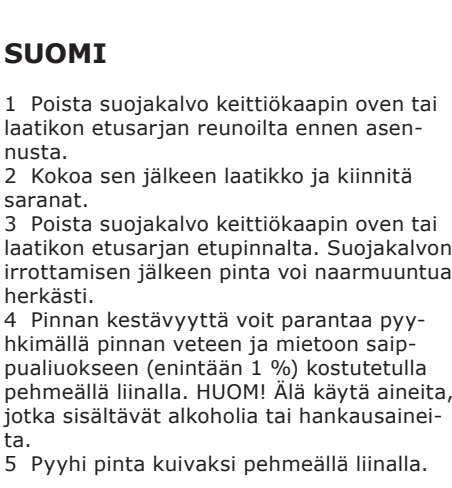

Igapäevaseks puhastamiseks vt punkti 4.

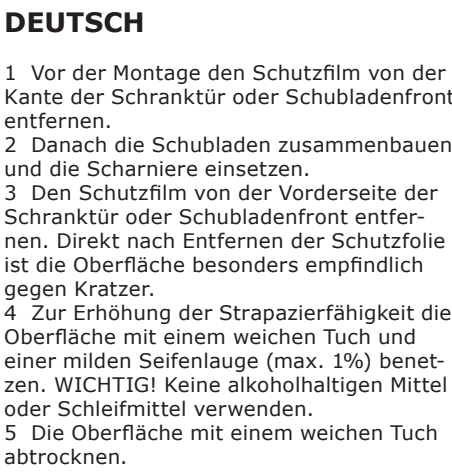

Pour l’entretien quotidien : voir point 4.

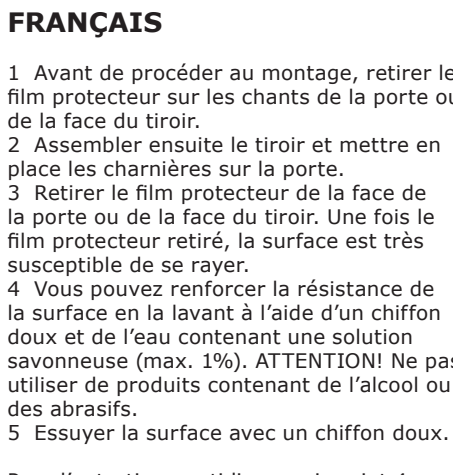
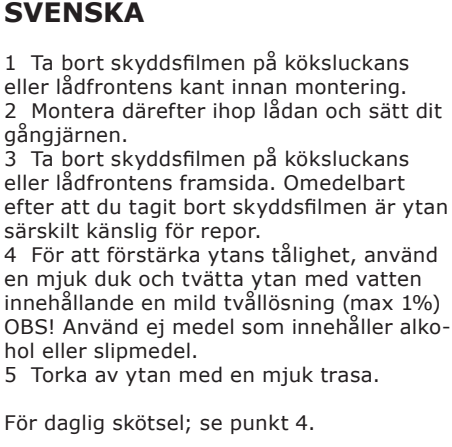

Pour l’entretien quotidien : voir point 4.

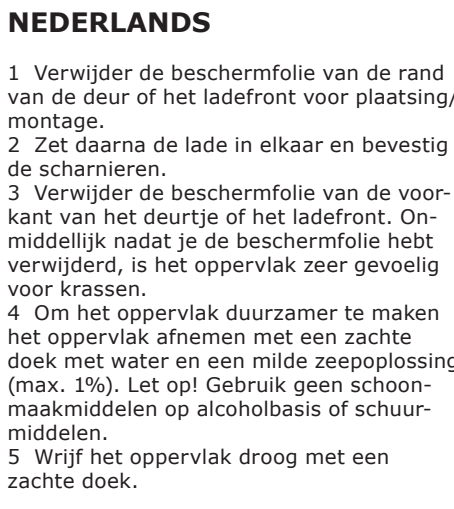
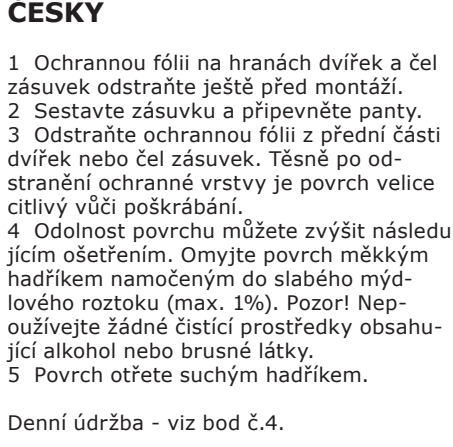

Zie voor dagelijks reinigen punt 4.

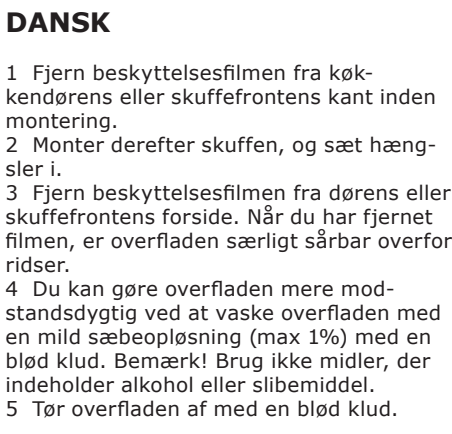
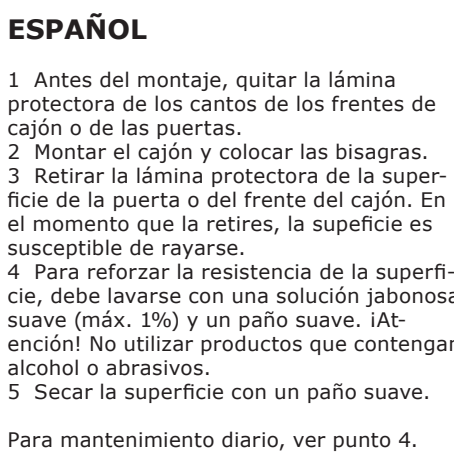

Daglig vedligeholdelse, se punkt 4.

^[1] Fjarlægið hlífðarfilmuna af brún hurðarinnar eða skúffuframhliðarinnar fyrir samsetningu/uppsetningu

^[2] Setjið skúffuna saman og festið laminar

^[3] Fjarlægið hlífðarfilmuna af framhlið hurðarinnar eða skúffuframhliðarinnar

^[4] Strax og hlífðarfilman hefur verið fjarlægð er yfirboðið sérstaklega viðkvæmt fyrir rísþum

^[5] Hægt er að auka viðnám yfirborðsins með því að herða það

^[6] Þvíð yfirborðið með mjúkum klút og mildri sápulausn (1% að hámarki)

^[7] Athugið! Notið ekki hreinsiefni sem innihalda alkóhól eða svarfefni

1

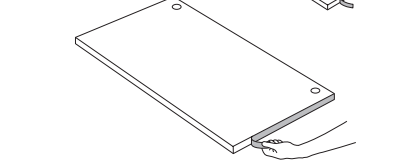

2

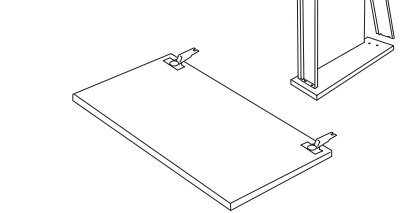

3

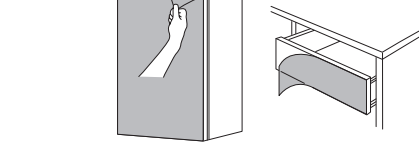

4

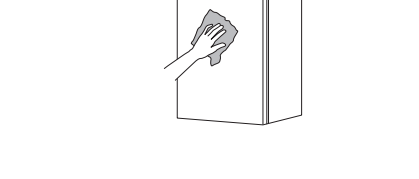

SLOVENŠČINA

- Pred montažo/sestavljanjem odstranite zaščitno folijo z robov vrat ali sprednje stranice predala.
- Sestavite predal in namestite spone.
- Odstranite zaščitno folijo z vrat oz. sprednje stranice predala. Takoj ko odstranite zaščitno folijo, je površina zelo dovzetna za praske.
- Površinsko odpornost lahko povečate tako, da jo prebršete z vlažno krpo in nežno milnico (max. 1%). Pozor! Ne uporabljajte čistil, ki vsebujejo alkohol ali abrazivna sredstva.
- Obrišite površino s čisto krpo.

Vsakodnevno čiščenje, glej točko 4.



- Tanggalkan lapisan pelindung daripada tepi pintu atau laci sebelum memasangnya.
- Pasang laci dan engsel.
- Tanggalkan lapisan pelindung daripada depan pintu dan depan laci. Selepas lapisan pelindung ditanggalkan, permukaan mudah calar.
- Untuk menguatkan ketahanan permukaannya, cuci permukaan dengan larutan sabun yang lembut (mak. 1%)dan gunakan kain lembut. Nota! Jangan gunakan sebarang pencuci yang mengandungi alkohol atau bahan kasar.
- Lap permukaan dengan kain kering.

Untuk cucian harian, lihat poin 4.

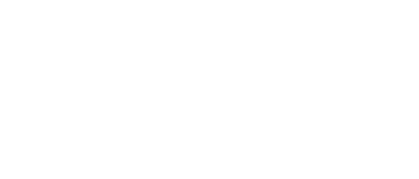

SLOVENSKY

- Predtým ako začnete montáž, odstráňte ochrannú fóliu z hrán dvierok resp. zásuvky.
- Zásuvku zložte a namontujte pánty.
- Odstráňte ochrannú fóliu z prednej časti dvierok resp. zásuvky. Tesne po odstránení fólie je povrch zvlášť citlivý na poškriabanie.
- Aby ste zvýšili odolnosť povrchu, umyte ho mäkkou handrou a jemným mydlovým roztokom (max. 1%). Upozornenie! Nepoužívajte čistiace prostriedky s obsahom alkoholu alebo drsných častíc.
- Povrch utrite suchou handrou.

Pre každodennú starostlivosť viď bod 4.

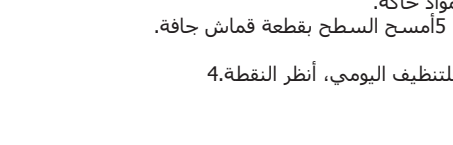
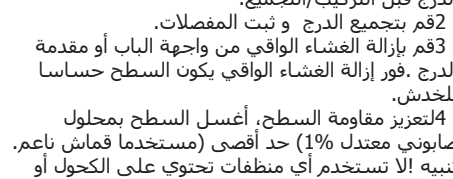
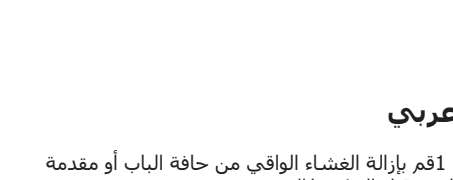
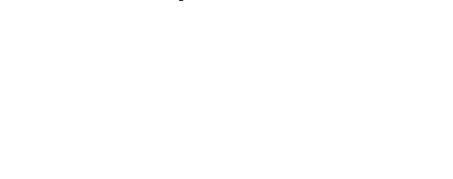
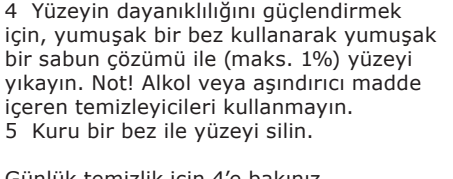
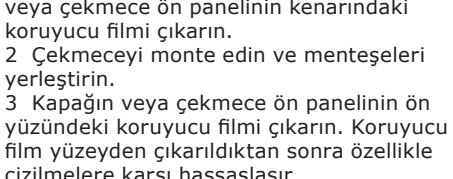
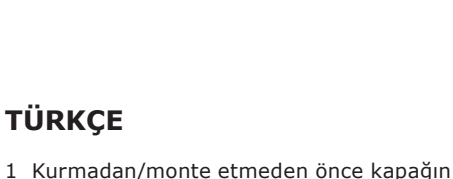
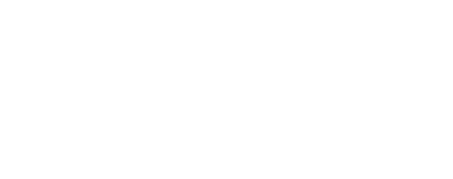

БЪЛГАРСКИ

- Махнете предпазителя от ръба на предната част на вратата или чекмеджето преди монтаж/сглобяване.
- Сглобете чекмеджето и поставете пантите.
- Махнете предпазителя от лицето на предната част на вратата или чекмеджето преди монтаж/сглобяване. Непосредствено след това повърхността е особено чувствителна на издрасквания.
- За да я направите по-издръжлива, я измийте с мек сапунен разтвор (макс. 1%) с помощта на мека кърпа. Внимание! Не използвайте почистващи препарати, съдържащи спирт или абразиви.
- Забършете повърхността със суха кърпа.

За ежедневно почистване вижте точка 4.

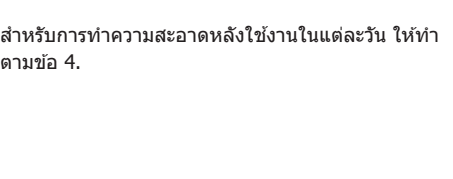
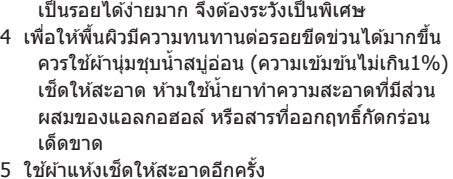
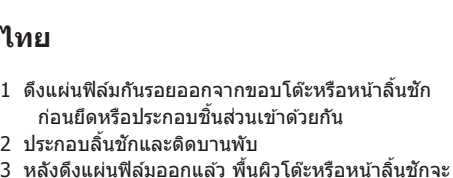
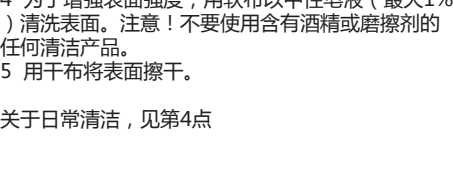
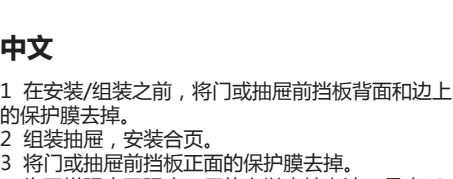

HRVATSKI

- Skinite zaštitni film s ruba vrata ili fronte ladice prije montaže/sastavljanja.
- Sastavite ladicu i postavite šarke.
- Skinite zaštitni film s vrata ili fronte ladice. Površina je posebno osjetljiva na ogrebotine nakon što skinete zaštitni film.
- Kako biste povećali otpornost površine, operite je mekanom krpom i blagom sapunskom otopinom (maks. 1 %). Napomena! Ne koristite sredstva za čišćenje koja sadrže alkohol ili abrazive.
- Obrišite površinu suhom krpom.

Za svakodnevno čišćenje vidi točku 4.

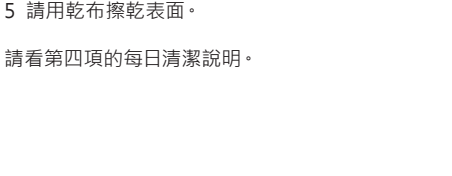
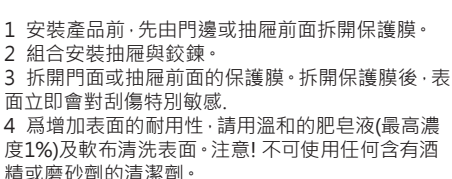
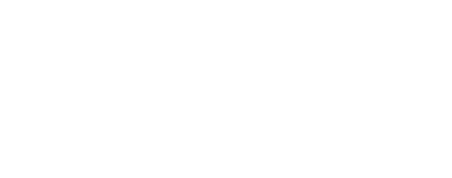
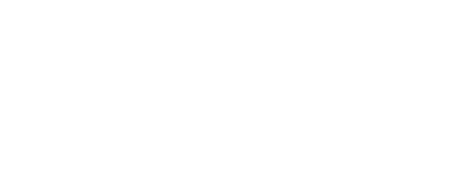

ΕΛΛΗΝΙΚΑ

- Прив από την τοποθέτηση/ συναρμολόγηση, αφαιρέστε την προστατευτική μεμβράνη από τα πλαίσια της πόρτας ή της εμπρός όψης του συρταριού.
- Συναρμολογήστε το συρτάρι και τοποθετήστε τους μεντεσέδες.
- Αφαιρέστε την προστατευτική μεμβράνη από την εμπρός όψη της πόρτας ή του συρταριού. Αμέσως μετά την αφαίρεση της προστατευτικής μεμβράνης, η επιφάνεια είναι πολύ ευαίσθητη στα γδαρσίματα.
- Για να αυξήσετε την αντοχή της πόρτας, πλύντε την με ένα μαλακό πανί, χρησιμοποιώντας μια ελαφριά διάλυση σαπουνιού (μεγ.1%). Σημείωση! Μην χρησιμοποιείτε οποιοδήποτε απορρυπαντικό που να περιέχει οινόπνευμα ή λειαντικά.
- Σκουπίστε την επιφάνεια με ένα στεγνό πανί.

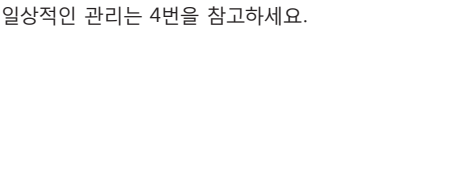
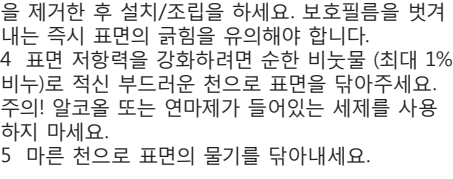
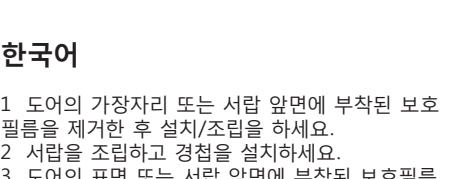
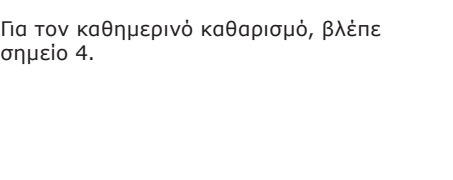

РУССКИЙ

- Перед установкой/сборкой снимите защитную плёнку с края и обратной стороны двери или фронтальной панели ящика.
- Соберите ящик и установите петли.
- Удалите защитную пленку с фронтальной поверхности дверцы ящика. После удаления пленки поверхность особенно подвержена повреждениям.
- Чтобы повысить ее износостойкие качества, протрите поверхность мягкой тканью, смоченной в слабом мыльном растворе (макс. 1%). Внимание! Не пользуйтесь средствами, содержащими спирт или абразивы.
- Вытрите поверхность сухой тканью.

Для повседневногo ухода см. пункт 4.

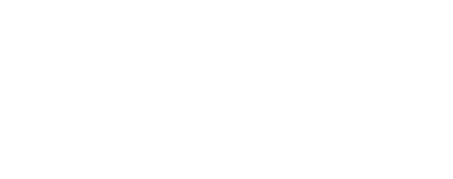
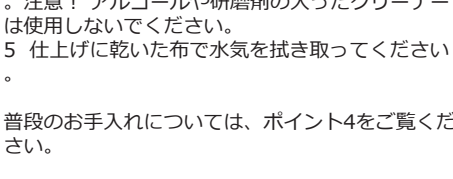
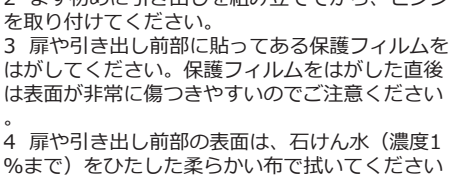
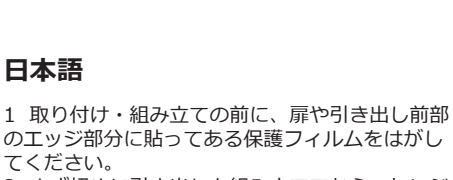

SRPSKI

- Ukloni zaštitnu foliju sa ivice vrata ili fronta fioke pre montiranja/sastavljanja.
- Sastavi fioku i postavi šarke.
- Ukloni zaštitnu foliju s lica vrata ili s lica fronta fioke. Neposredno pošto se ukloni zaštitna folija, površina je naročito osetljiva na ogrebotine.
- Da pojačaš otpornost površine, operi je blagim rastvorom sapuna (maks. 1%) koristeći se mekanom krpom. Važno! Ne upotrebljavaj sredstvo za čišćenje koje sadrži alkohol ili abraziv.
- Prebriši površinu suvom krpom.

Za svakodnevno čišćenje, vidi tačku 4.

