

USER MANUAL

ProLite

LCD Monitor

ENGLISH

A decorative graphic consisting of several blue squares of varying sizes and opacities, arranged in a scattered pattern across the page. Some squares are solid blue, while others are semi-transparent or have a halftone dot pattern.

ProLite LH4282SB
ProLite LH4982SB
ProLite LH5582SB

Thank you very much for choosing the iiyama LCD monitor.

We recommend that you take a few minutes to read this comprehensive manual carefully before installing and switching on the monitor. Please keep this manual in a safe place for your future reference.



Dear user, we congratulate you on the purchase of your iiyama LCD.

For details on warranty and locally used pixel policies that apply directly after installation of your product please check the iiyama website.

To report a fault, please contact your local support centre found at www.iiyama.com/service

Things to check before you call the iiyama information line

- | if the power cable is connected securely and turned on?
- | if the display has been turned on?
- | if the signal cable is connected securely and the correct input selected?
- | if the computer has been restarted with the display connected?
- | if the graphics card is correctly installed with the latest drivers possible?
- | if the correct native resolution has been selected via 'Display Properties'?
- | If the R/G/B signal configuration is correct?
- | if the displays On Screen Menu is shown?
- | if the correct brightness and contrast settings have been set?
- | if given display tolerances and compatibility have been considered?
- | if via the On Screen Menu you have performed a Factory Reset/Recall?

Before reporting the screen defect, please prepare the following information/evidence:

- | model number *
- | purchase receipt and serial number *
- | name and address for collection
- | telephone/fax number, for availability during the day
- | convenient collection date (date, time)
- | short description of the defect

Important Note:

If there is no fault found in the collected equipment after inspection, the transferring party shall incur charges for transport and administration.

If you have checked all of the above and there is still no picture, call our information line for assistance in your country.

* see the identification plate on the back of the case.

CE MARKING DECLARATION OF CONFORMITY

This LCD monitor complies with the requirements of the EC/EU Directive 2014/30/EU "EMC Directive", 2014/35/EU "Low Voltage Directive" and 2011/65/EU "RoHS Directive".

Warning

This is a class A product. In a domestic environment this product may cause radio interference in which case the user may be required to take adequate measures.

IYAMA CORPORATION: Wijkemeerstraat 8, 2131 HA Hoofddorp, The Netherlands

Model No. : PL4282/PL4982/PL5582



We recommend recycling of used product. Please contact your dealer or iiyama service center. Recycle information is obtained via the Internet, using the address: <http://www.iiyama.com>

You can access the Web page of different countries from there.

- We reserve the right to change specifications without notice.
- All trademarks used in this user manual are the property of their respective owners.

TABLE OF CONTENTS

FOR YOUR SAFETY.....	1
SAFETY PRECAUTIONS.....	1
SPECIAL NOTES ON LCD MONITORS.....	3
CUSTOMER SERVICE.....	5
CLEANING.....	5
BEFORE YOU OPERATE THE MONITOR.....	6
FEATURES.....	6
CHECKING THE CONTENTS OF THE PACKAGE.....	6
UNPACKING : ProLite LH4982SB / ProLite LH5582SB.....	7
CONTROLS AND CONNECTORS : MONITOR.....	8
INSTALLATION.....	11
CONTROLS AND CONNECTORS : REMOTE CONTROL.....	12
PREPARING THE REMOTE CONTROL.....	13
ID REMOTE CONTROL.....	14
BASIC OPERATION.....	15
CONNECTING YOUR THE MONITOR.....	18
COMPUTER SETTING.....	23
OPERATING THE MONITOR.....	24
ADJUSTMENT MENU CONTENTS.....	26
POWER MANAGEMENT FEATURE.....	41
TROUBLE SHOOTING.....	42
RECYCLING INFORMATION.....	43
APPENDIX.....	44
SPECIFICATIONS : ProLite LH4282SB.....	44
SPECIFICATIONS : ProLite LH4982SB.....	45
SPECIFICATIONS : ProLite LH5582SB.....	46
DIMENSIONS : ProLite LH4282SB.....	47
DIMENSIONS : ProLite LH4982SB.....	47
DIMENSIONS : ProLite LH5582SB.....	48
COMPLIANT TIMING.....	49

FOR YOUR SAFETY

SAFETY PRECAUTIONS

WARNING

STOP OPERATING THE MONITOR WHEN YOU SENSE TROUBLE

If you notice any abnormal phenomena such as smoke, strange sounds or fumes, unplug the monitor and contact your dealer or iiyama service center immediately. Further use may be dangerous and can cause fire or electric shock.

NEVER REMOVE THE CABINET

High voltage circuits are inside the monitor. Removing the cabinet may expose you to the danger of fire or electric shock.

DO NOT PUT ANY OBJECT INTO THE MONITOR

Do not put any solid objects or liquids such as water into the monitor. In case of an accident, unplug your monitor immediately and contact your dealer or iiyama service center. Using the monitor with any object inside may cause fire, electric shock or damage.

INSTALL THE MONITOR ON A FLAT, STABLE SURFACE

The monitor may cause an injury if it falls or is dropped.

DO NOT USE THE MONITOR NEAR WATER

Do not use where water may be splashed or spilt onto the monitor as it may cause fire or electric shock.

OPERATE UNDER THE SPECIFIED POWER SUPPLY

Be sure to operate the monitor only with the specified power supply. Use of an incorrect voltage will cause malfunction and may cause fire or electric shock.

PROTECT THE CABLES

Do not pull or bend the power cable and signal cable. Do not place the monitor or any other heavy objects on the cables. If damaged, the cables may cause fire or electric shock.

ADVERSE WEATHER CONDITIONS

It is advisable not to operate the monitor during a heavy thunder storm as the continual breaks in power may cause malfunction. It is also advised not to touch the plug in these circumstances as it may cause electric shock.

CAUTION

INSTALLATION LOCATION

Do not install the monitor where sudden temperature changes may occur, or in humid, dusty or smoky areas as it may cause fire, electric shock or damage. You should also avoid areas where the sun shines directly on the monitor.

DO NOT PLACE THE MONITOR IN A HAZARDOUS POSITION

The monitor may topple and cause injury if not suitably located. Please also ensure that you do not place any heavy objects on the monitor, and that all cables are routed such that children may not pull the cables and possibly cause injury.

MAINTAIN GOOD VENTILATION

Ventilation slots are provided to keep the monitor from overheating. Covering the slots may cause fire. To allow adequate air circulation, place the monitor at least 10 cm (or 4 inches) from any walls. Do not remove the tilt stand when operating the monitor. Ventilation slots on the back of the cabinet will be blocked and the monitor may overheat if the stand is removed. This may cause fire or damage. Operating the monitor on its back, side, upside down or on a carpet or any other soft material may also cause damage.

DISCONNECT THE CABLES WHEN YOU MOVE THE MONITOR

When you move the monitor, turn off the power switch, unplug the monitor and be sure the signal cable is disconnected. If you do not disconnect them, it may cause fire or electric shock.

UNPLUG THE MONITOR

If the monitor is not in use for a long period of time it is recommended that it is left unplugged to avoid accidents.

HOLD THE PLUG WHEN DISCONNECTING

To disconnect the power cable or signal cable, always pull it by the plug. Never pull on the cable itself as this may cause fire or electric shock.

DO NOT TOUCH THE PLUG WITH WET HANDS

Pulling or inserting the plug with wet hands may cause electric shock.

WHEN YOU INSTALL THE MONITOR ON YOUR COMPUTER

Be sure the computer is strong enough to hold the weight of the monitor, otherwise, you may damage your computer.

OTHERS

ERGONOMIC RECOMMENDATIONS

To eliminate eye fatigue, do not operate the monitor against a bright background or in a dark room. For optimal viewing comfort, the monitor should be just below eye level and 40-60 cm (16-24 inches) away from your eyes. When using the monitor over a prolonged time, a ten minute break every hour is recommended as looking at the screen continuously can cause eye strain.

SPECIAL NOTES ON LCD MONITORS

- The following symptoms are normal with LCD monitors and do not indicate a problem.

NOTE

- When you first turn on the LCD monitor, the picture may not fit in the display area because of the type of computer that is used. In this case, adjust the picture position to the correct position.
 - You may find slightly uneven brightness on the screen depending on the desktop pattern you use.
 - Due to the nature of the LCD screen, an afterimage of the previous screen may remain after switching the image, when the same image is displayed for hours. In this case, the screen is recovered slowly by changing the image or turning off the Power Switch for hours.
- This LCD cannot be used outdoors.
 - This LCD cannot be used with the screen facing upwards.
 - If you use a cable longer than the supplied one, the picture quality is not guaranteed.

USAGE CONFIRMATION

This product is designed for optimum usage at 24hours per day.
The display is compatible for usage in Landscape/Portrait applications.

IMAGE PERSISTENCE / IMAGE STICKING

Please be aware that all LCD screens can experience Image Persistence or Image Sticking. This occurs when a residual image remains visible on a screen when static images are displayed for long periods of time. LCD Image Persistence is not permanent but constant images being displayed for a long period of time should be avoided.

To counteract Image Persistence, turn off the monitor for as long as the previous image was displayed, so if an image was on the monitor for 1 hour and there is evidence of a residual or “ghost” image, you should turn off the monitor for 1 hour in order to clear the residual image.

For all LFD products, iiyama recommends displaying moving images and utilising a moving screen saver at regular intervals whenever the screen is idle. You could also turn off the monitor when not in use to assist the prevention.

Other ways to reduce the risk of Image Persistence will be to utilise the FAN-on function (if available), Low Backlight and Low Brightness settings.

FOR EXTENDED USE AS A PUBLIC DISPLAY

■ Image Sticking on LCD Panel

When a static image is displayed for hours, an electric charge trace remains near the electrode inside the LCD producing a “ghost” image. (Image Persistence).

Image Persistence is not a permanent feature.

■ Recommendations

To prevent Image Sticking and promote longer life expectancy of display, we recommend the following:

1. Avoid static images displayed for long periods – change static images on continuous loop.
2. Turn off monitor when not in use, either by remote control or use Power Management or Schedule functions.
3. When monitor is installed in high ambient temperature environment(s) or in an enclosed position, utilise the Cooling Fan, Screen Saver and Low Brightness functions.
4. Suitable ventilation for any monitor is an expectation of any installation – climate control systems may need to be employed.
5. We strongly recommend utilisation of active cooling with fans for long operation times or high ambient temperature environments.

CUSTOMER SERVICE

NOTE

- If you have to return your unit for service and the original packaging has been discarded, please contact your dealer or iiyama service center for advice or replacement packaging.

CLEANING

WARNING

- If you drop any materials or liquids such as water into the monitor when cleaning, unplug the power cable immediately and contact your dealer or iiyama service center.

CAUTION

- For safety reasons, turn off the power switch and unplug the monitor before you clean it.

NOTE

- To protect the LCD panel, do not scratch or rub the screen with a hard object.
- Never use any of the following strong solvents. These will damage the cabinet and the LCD screen.

Thinner	Benzine	Abrasive cleaner
Spray-type cleaner	Wax	Acid or Alkaline solvent

- Touching the cabinet with any product made from rubber or plastic for a long time may cause degeneration or loss of paint on the cabinet.

CABINET

Stains can be removed with a cloth lightly moistened with a mild detergent solvent. Then wipe the cabinet with a soft dry cloth.

LCD

Periodic cleaning with a soft dry cloth is recommended.

SCREEN

Don't use tissue paper etc. because these will damage the LCD screen.

BEFORE YOU OPERATE THE MONITOR

FEATURES

- ◆ Supports Resolutions up to 1920 × 1080
- ◆ High Contrast 1300:1 (Typical) / Brightness 700cd/m² (Typical)
- ◆ Digital Character Smoothing
- ◆ Automatic Set-up
- ◆ Stereo Speakers
2 × 10W Stereo Speakers
- ◆ Plug & Play VESA DDC2B Compliant
Windows[®] XP/Vista/7/8/8.1/10 Compliant
- ◆ Power Management (VESA DPMS Compliant)
- ◆ VESA Mounting Standard (200mm×200mm) Compliant : ProLite LH4282SB
- ◆ VESA Mounting Standard (400mm×400mm) Compliant : ProLite LH4982SB / ProLite LH5582SB
- ◆ Support 24hrs/day usage (by moving picture condition)
- ◆ VESA Compatible arm mounting interface
- ◆ Daisy Chain support
- ◆ Slim Design

CHECKING THE CONTENTS OF THE PACKAGE

The following accessories are included in your package. Check to see if they are enclosed with the monitor. If anything is missing or damaged, please contact your local iiyama dealer or regional iiyama office.

- | | | |
|-------------------|---------------------|---------------------|
| ■ Power Cable* | ■ DVI-D Cable | ■ HDMI Cable |
| ■ mDP-DP Cable | ■ DisplayPort Cable | ■ RS-232C Cable |
| ■ Remote Control | ■ Battery (2pcs) | ■ POP Label |
| ■ EU Energy Label | ■ Safety Guide | ■ Quick Start Guide |

CAUTION

- * The rating of the Power Cable enclosed in 120V area is 10A/125V. If you are using a power supply higher than this rating, then a power cable with a rating of 10A/250V must be used. However, all guarantees and warranties are void for any problems or damage caused by a power cable not supplied by iiyama.

UNPACKING : ProLite LH4982SB / ProLite LH5582SB

- ① Before unpacking your monitor, prepare a stable, level, and clean surface near a wall outlet. Set the LCD monitor box in an upright position and open from the top of the box before removing the top cushions.
- ② Remove the carton holders.
- ③ Remove the top cushion and take the accessories box and the monitor out.

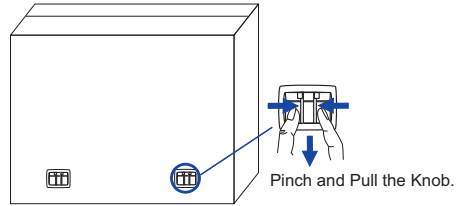
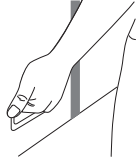

CAUTION

- Moving the monitor requires at least two people. If not, it may drop and could result in a serious injury.
- Two individuals can lift the monitor out of the box by holding the bottom of the unit.
- Do not hold the monitor by the top bezel while lifting out.
- Do not touch the LCD panel surface while lifting out.

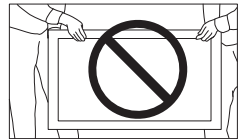
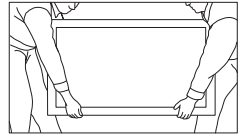

CONTROLS AND CONNECTORS : MONITOR

<Back Controller>

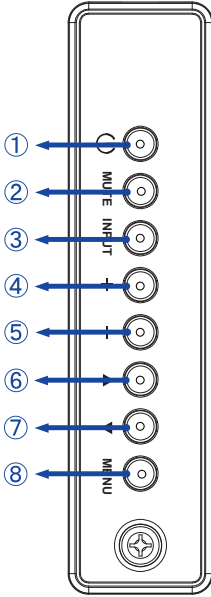

<Front>



①		Power Button
②	MUTE	Mute Button
③	INPUT	Enter / Input Select Button
④	+	+ Button
⑤	-	- Button
⑥	▲	Up Button
⑦	▼	Down Button
⑧	MENU	Menu Button

<Remote sensor and power indicator - location>

1. Pull down the lens to improve remote control performance and ensure good visibility of the power status diode.
2. Push up the lens before mounting the monitor for video wall application.
3. Pull/Push the lens until hearing the click sound.

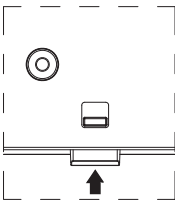

Push up to hide the lens

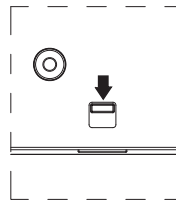

Push down to extend the lens

● ProLite LH4282SB

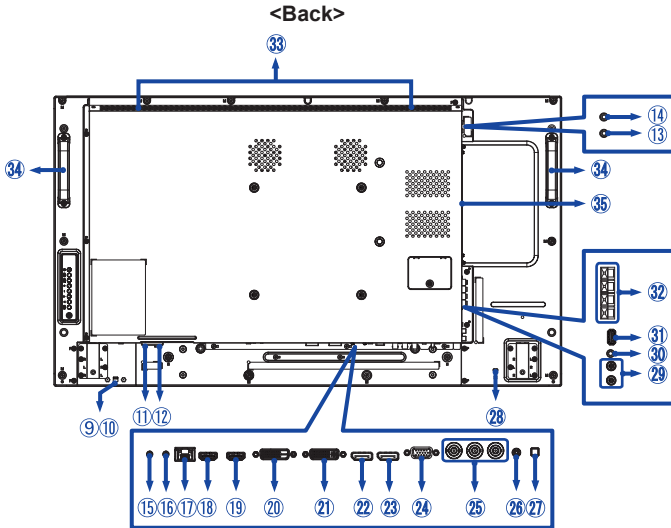

⑨	Power Indicator	Green	Lighting : Normal Operation Flash : Power Management (ECO Mode : Normal) * If there is no input signal from the computer and passes for 10 minutes.
		Orange	If turn off the Power Button on the Remote Control and the Back Controller. Power Management (ECO Mode : Normal)
		Red	If turn off the Power Button on the Remote Control and the Back Controller. Power Management (ECO Mode : Low power standby)
		Off	Power Off
⑩	Remote Sensor		Remote Sensor
⑪	AC IN	AC-INLET	AC Connector(~ : Alternating current) (AC-IN)
⑫	AC SWITCH I (ON) / O (OFF)	MAIN POWER	Main Power Switch
⑬	IR IN	IR	IR Connector
⑭	IR OUT	IR	IR Connector
⑮	RS232C IN	Mini Jack	RS232C Connector
⑯	RS232C OUT	Mini Jack	RS232C Connector
⑰	LAN	RJ45	RJ45 Connector
⑱	HDMI1 IN	HDMI	HDMI Connector
⑲	HDMI2 IN	HDMI	HDMI Connector
⑳	DVI IN	DVI-D	DVI-D Connector

● ProLite LH4982SB / ProLite LH5582SB

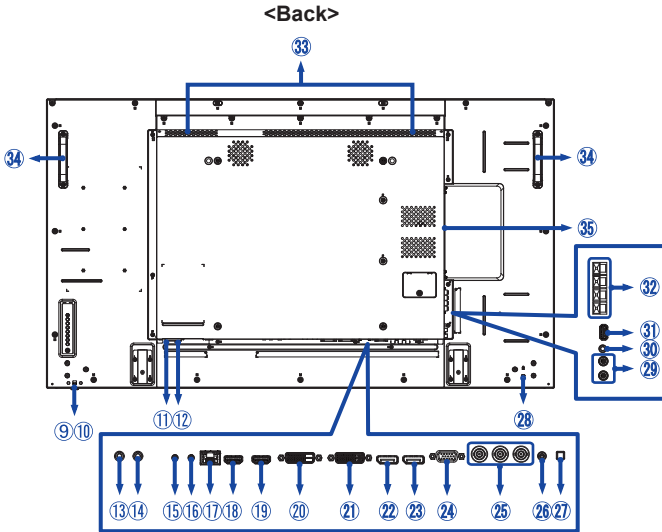

⑪	DVI OUT	DVI-D	DVI-D Connector
⑫	DisplayPort IN	DisplayPort	DisplayPort Connector
⑬	DisplayPort OUT	DisplayPort	DisplayPort Connector
⑭	VGA IN	VGA	VGA Connector
⑮	COMPONENT VIDEO (VIDEO IN)	RCA G/B/R	Component Video Connector
⑯	PC AUDIO IN	Mini Jack	Audio Connector
⑰	SPEAKER SWITCH		Internal speaker On/Off switch
⑱	Keyhole for Security Lock		Keyhole for Security Lock
⑲	AUDIO IN	RCA L/R	Audio Connector
⑳	AUDIO OUT	RCA L/R	Headphone Connector
㉑	USB	USB	USB Connector
㉒	SPEAKERS OUT	Jack	External Speakers Connector
㉓	SPEAKERS		Speakers
㉔	Handles		Handles
㉕	Option Slot (Card OPS)		Option Slot

INSTALLATION

CAUTION

- Follow the manual instructions for the type of mount you have selected. Refer all servicing to qualified service personnel.
- Moving the monitor requires at least two people.
- Before installing, please make sure the wall is strong enough to hold the necessary weight of the monitor and the mount.

[WALL MOUNTING]

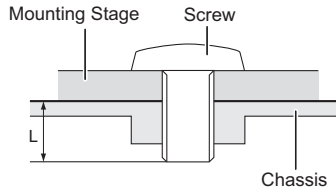

CAUTION

When using the wall mounting, consideration of thickness of the mounting stage needs to be taken. Tighten the M6 Screw with washer which “L” length is 10mm to fasten the monitor. Using a screw longer than this may cause electric shock or damage because it may contact with the electrical parts inside the monitor.

[ROTATING THE MONITOR]

It is designed to be compatible in both landscape and portrait modes.

NOTE

Monitor should be turned clockwise based on front view when used in portrait mode. (Set in the PC)

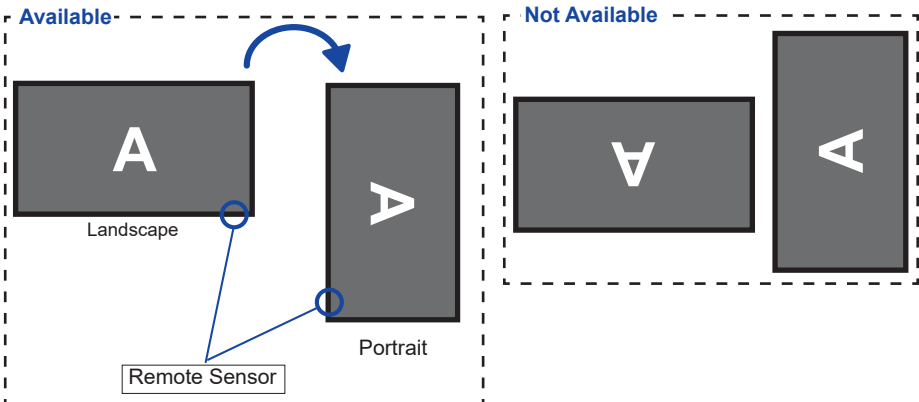

CONTROLS AND CONNECTORS : REMOTE CONTROL

ENGLISH

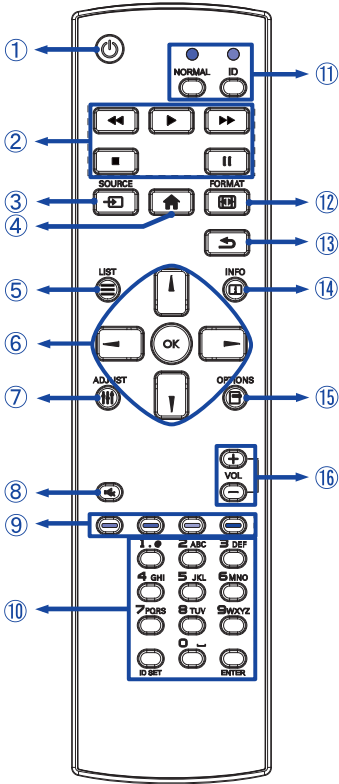

①		Turns the monitor ON and OFF.
②	[PLAY]	Control playback of media files. ▶ : Play ■ : Stop : Pause ◀◀ : Quick-Return ▶▶ : Fast-Forward
③	SOURCE	Selects the source. Press ▲ or ▼ button to select from USB, Network, HDMI1, HDMI2, DisplayPort, Card OPS, DVI, YPbPr, AV or VGA. Press [OK] button to confirm and exit.
④		Opens the monitor's on-screen menu systems.
⑤		Not available on this model.
⑥		Navigates through submenus and settings. ▲ : Up Button ▼ : Down Button
		◀ : Left Button ▶ : Right Button
	OK	Confirms your selection or save changes.
⑦		Selects the direct menu. PC mode : Sound Mode, Audio out, Picture format, Picture shift Video mode : Picture Mode, Sound Mode, Audio out, Picture format, Picture shift
⑧		Turns on or off the mute function when the Menu is not displayed.
⑨		Select tasks or options.
⑩	NUMBER/ ID SET/ENTER	Enter text for network setting.
⑪	ID Mode	ID: To enter ID Mode NORMAL: To leave ID Mode
⑫		Change picture format.
⑬		Returns to a previous menu or closes the OSD Menu.
⑭		Provides source and resolution information.
⑮		Access currently available options, picture and sound menus.
⑯	VOLUME - / +	VOLUME-: Decreases the sound volume. VOLUME+: Increases the sound volume.

PREPARING THE REMOTE CONTROL

To use the remote control, insert the two dry batteries.

CAUTION

Do not use any other batteries other than those specified in this manual for the Remote Control. Do not insert old and new batteries together in the Remote Control. Make sure that the terminals match the "+" and "-" indications in the battery compartment. Burst batteries or the electrolyte from these batteries may cause stains, fire or injury.

- 1 Press and then slide the battery cover to open it.

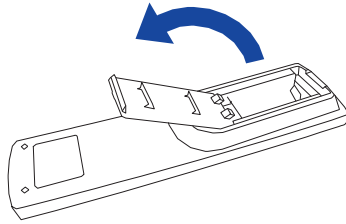

- 2 Align and insert two AAA batteries according to their plus and minus ports (as indicated in the remote control).

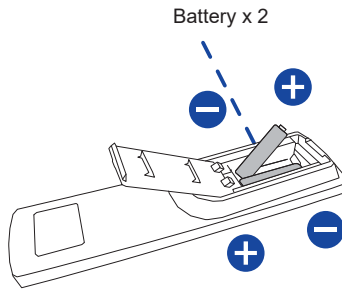

- 3 Replace the battery cover.

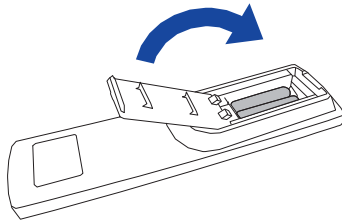

NOTE

- Replace with new batteries when the Remote Control does not work close to the monitor. Use AAA dry batteries.
- Operate the Remote Control by pointing it toward the Remote Sensor on the monitor.
- Other manufacturers remote control will not work with this monitor. Use the provided Remote Control ONLY.
- Used batteries needed to follow the local rules to be discarded. (Suggestion: to dispose of used batteries please follow correct policy as per your local regulations.)

ID REMOTE CONTROL

You can set the remote control ID when you want to use the remote control on specific monitors.

ID Mode (To enter ID Mode) : Press and hold the ID button until the red LED blinks twice.

Normal Mode (To leave ID Mode) : Press and hold the Normal button until the green LED blinks twice.

■ Programming ID Mode

To assign an ID to a remote control.

1. Enter ID Mode.
2. Press and hold the ID SET button until the red LED turned on.
3. Using the number button, input the desired ID. (01 - 255)
4. Press the ENTER button to confirm ID.
5. The red LED will blink twice when ID has been confirmed.
6. Press the ID SET button will exit the ID Mode. The LED lights off.

NOTE

- Not pressing any button within 10 seconds will exit the ID Mode.
- If an error pressing of buttons other than the digits occurred, wait 1 second after the red LED lights off and then lights up again, then press the correct digits again.
- To cancel or stop programming an ID, press the ID SET button.
- It is necessary to set up the ID number for each monitor before selecting its ID number.

■ Use ID Mode

1. Enter ID Mode.
2. Input the ID of the monitor which would like to control by number button.
3. Press the ENTER button.

BASIC OPERATION

■ Turning the monitor ON

The monitor is turned On and the Power Indicator turns to Green when you press the POWER button on the monitor or the Remote Control. The monitor is turned Off and the Power Indicator turns to Orange when you press the POWER button on the monitor or the Remote Control. Press again to turn On the monitor.

NOTE

Even when using the power management mode or turning OFF the Power Switch, the monitor will consume a small amount of electricity. Disconnect the Power Cable from the power supply whenever the monitor is not in use or during the night, to avoid unnecessary power consumption.

[Monitor]

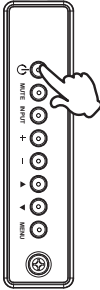

[Remote Control]

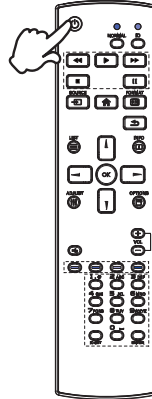

■ Display the adjustment menu page

The menu page appears on the screen when you press the MENU button on the monitor or the  HOME button on the Remote Control.

The menu page disappears when you press the  BACK button on the Remote Control again.

[Monitor]

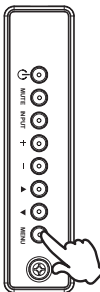

[Remote Control]

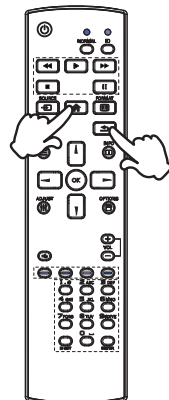

■ Move the cursor vertically

Select adjustment by pressing the ▲ / ▼ button on the monitor or the ▲ / ▼ button on the remote control while the menu page is displayed on the screen.

[Monitor]

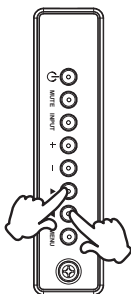

[Remote Control]

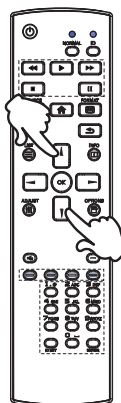

■ Move the cursor horizontally

Select menu or setting, or perform the adjustment by pressing the + / - button on the monitor or the ◀ / ▶ button on the remote control while the menu page is displayed on the screen.

[Monitor]

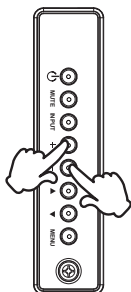

[Remote Control]

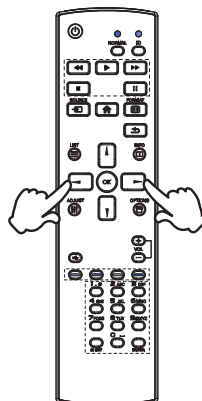

■ **Adjust the volume of sound**

Press the + / - button on the monitor or the remote control to adjust the volume of sound when the menu page is not displayed on the screen.

[Monitor]

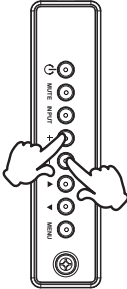

[Remote Control]

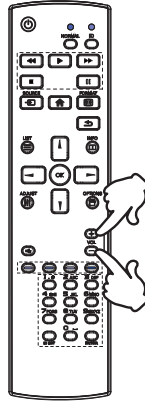

■ **Switch the input signal**

This is activated when you successively press the INPUT button on the monitor or the Remote Control.

[Monitor]

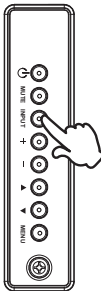

[Remote Control]

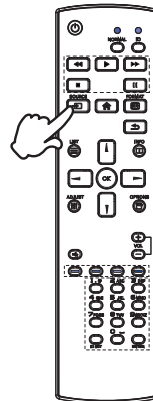

CONNECTING YOUR THE MONITOR

- ① Ensure that both the computer and the monitor are switched off.
- ② Connect the computer to the monitor with the signal cable.
- ③ Connect the computer to the monitor with the RS-232C Cable.
- ④ Connect the Power Cable to the monitor first and then to the power supply.
- ⑤ Turn on your monitor (Main Power Switch and Power Switch) and computer.

NOTE

- The signal cables used for connecting the computer and monitor may vary with the type of computer used. An incorrect connection may cause serious damage to both the monitor and the computer. The cable supplied with the monitor is for a standard connector. If a special cable is required please contact your local iiyama dealer or regional iiyama office.
- Make sure you tighten the finger screws at each end of the Signal Cable.
- Excessive sound pressure from ear-/headphones can cause hearing damage/hearing loss.

[Example of Connection]

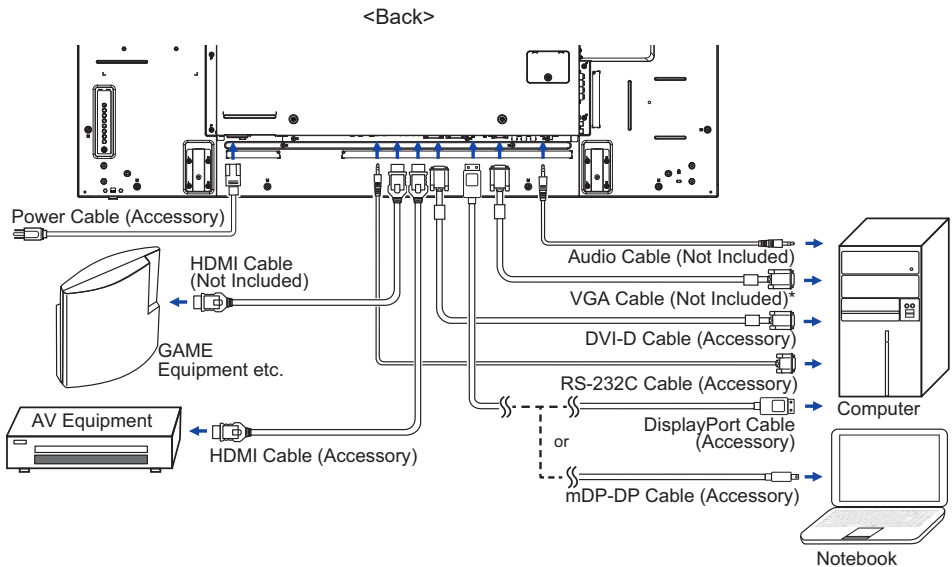

* VGA cable is not supplied with the monitor. If you use low quality VGA cable, it may cause a result of electro-magnetic interference. Please contact the iiyama Support Centre in your country if you wish to connect the monitor via the VGA input.

[Connection example with the peripheral device]

CAUTION

Turn off the power switch and unplug the monitor and peripherals before connection to avoid electric shock or damage.

NOTE

- Refer to the user manual of peripherals at the same time.
- Ensure you have the necessary cables as required.

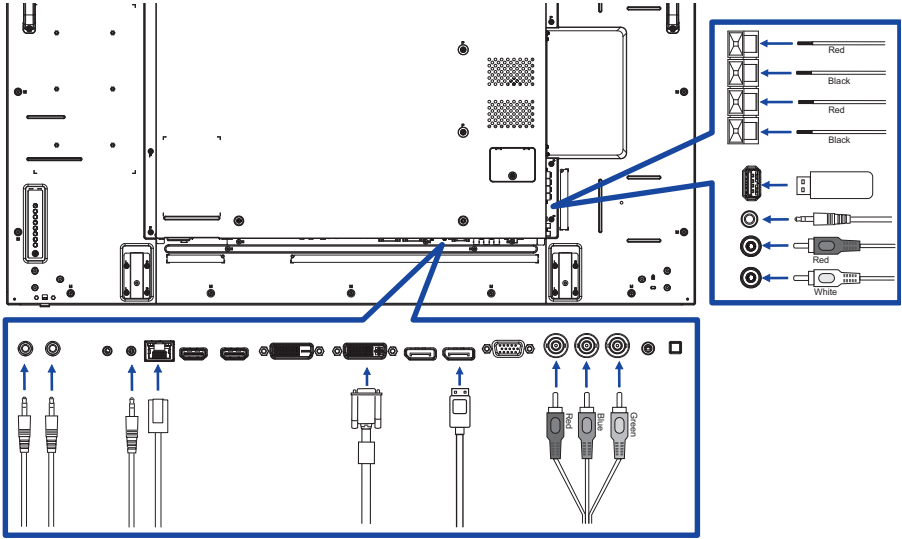

[About the daisy chain]

■ Monitor control connection

RS-232C

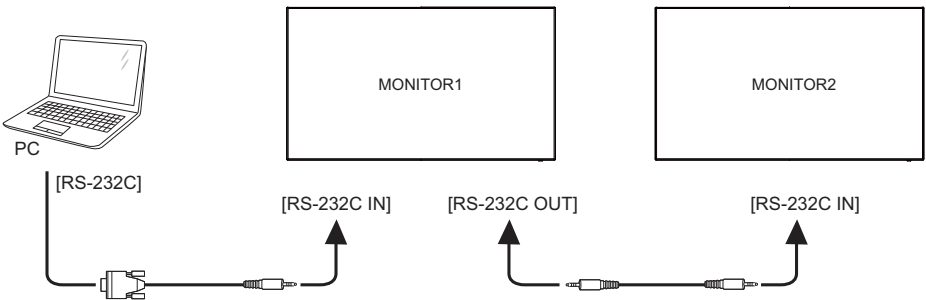

■ Digital video connection

DVI

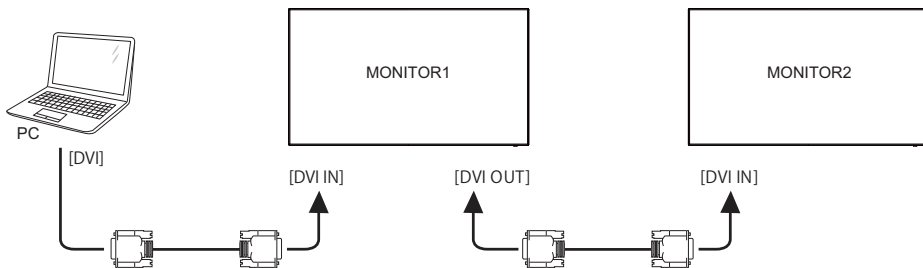

DisplayPort

DisplayPort v1.2 multiple stream support allows daisy-chain up to 4 monitors showing different content on each screen.

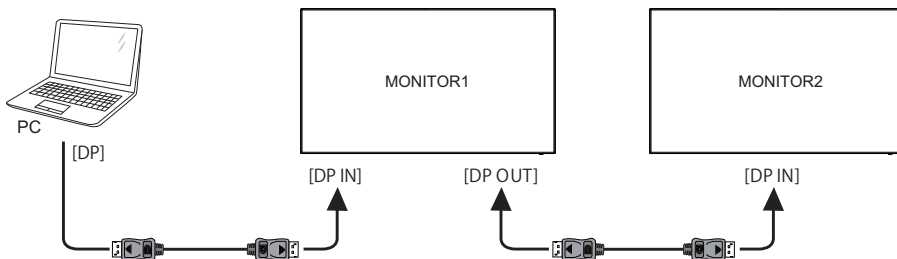

HDMI

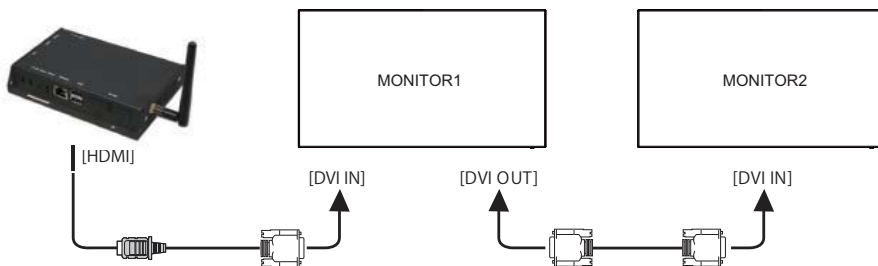

OPS

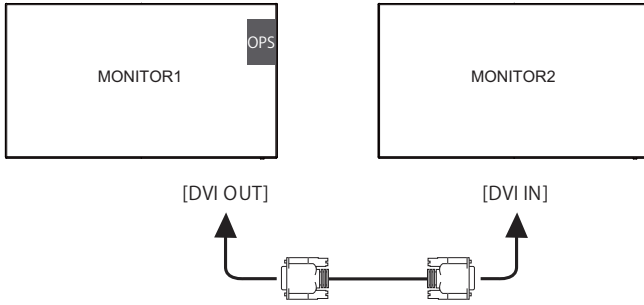

■ Analog video connection

VGA

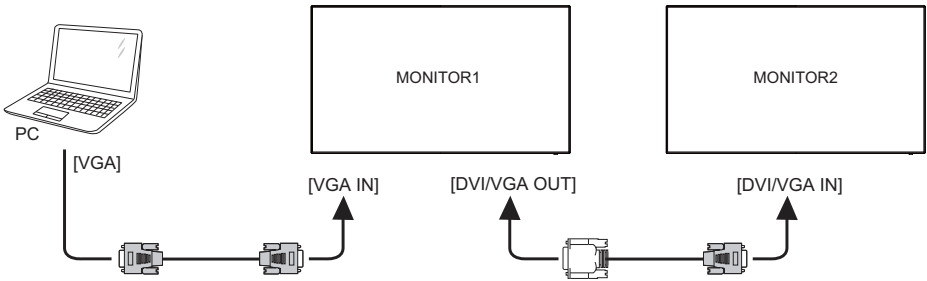

[To setup the network]

1. Switch on the router and switch on its DHCP setting.
2. Connect the router to this monitor and your computer with an Ethernet cable.
3. Press **HOME** button on the remote control, then select Setup.
4. Select "Connect to network", then press OK button.
5. Follow the on-screen instructions to install the network.
6. Wait for this monitor to find the network connection.
7. If you are prompted, agree to the "End User Licence Agreement".

NOTE Connecting with a shielded CAT-5 Ethernet cable to comply with the EMC directive.

■ Single monitor setup

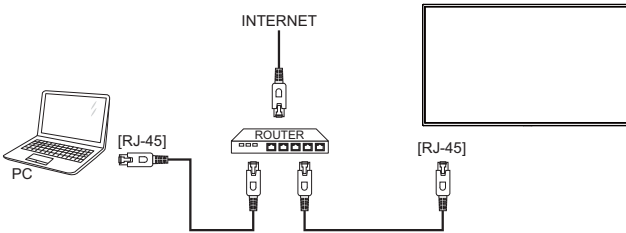

■ Multiple monitor setup

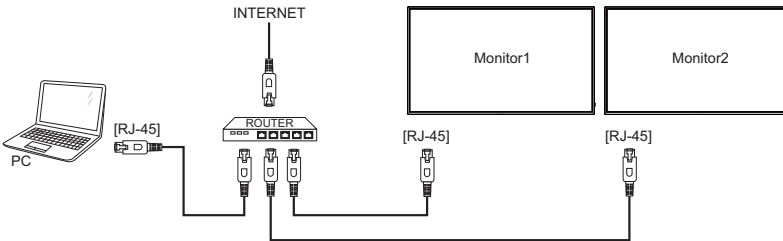

COMPUTER SETTING

■ Signal Timing

Change to the desired signal timing listed on page 49: COMPLIANT TIMING.

■ Windows XP/Vista/7/8/8.1/10 Plug & Play

The iiyama LCD monitor complies with DDC2B of VESA standard. The Plug & Play function runs on Windows XP/Vista/7/8/8.1/10 by connecting the monitor to DDC2B compliant computer with the Signal Cable supplied.

For installation on Windows XP: The monitor Information File for iiyama monitors may be necessary for your computer and obtained via the Internet, using the address:

<http://www.iiyama.com>

NOTE

- Monitor Drivers are not required in most cases for Macintosh or Unix operating systems. For further information, please contact your computer dealer first for advice.

■ Procedure for turning ON the Power Switch

Turn ON the monitor first, and then the computer.

OPERATING THE MONITOR

To create the best picture, your iiyama LCD monitor has been preset at the factory with the COMPLIANT TIMING shown on page 49. You are also able to adjust the picture by following the button operation shown below.

- 1 Press the **HOME** button on the remote control or the **MENU** button on the Monitor to start the On Screen Monitor feature. There are additional Menu items which can be switched by using the **▲/▼** buttons on the remote control or the **▲/▼** buttons on the monitor.

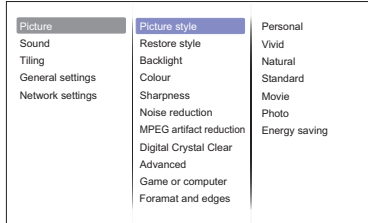

- 2 Select the Menu item of the adjustment you want to make. Press the **OK** button on the remote control or the **INPUT** button on the monitor and enter the menu page. Then, use the **▲/▼** buttons on the remote control or the **▲/▼** buttons on the monitor to highlight the desired adjustment item.
- 3 Press the **OK** button on the remote control or the **INPUT** button on the monitor again. Use the **▲/▼** buttons on the remote control or the **+/-** buttons on the monitor to make the appropriate adjustment or setting.
- 4 Press the **BACK** button on the remote control or the **MENU** button on the monitor to leave the menu, and the settings you just made would be automatically saved.

For example, to correct for sharpness, select Menu item of "Picture". Press the **OK** button on the remote control or the **INPUT** button on the monitor. Then, select "Sharpness" by using the **▲/▼** buttons on the remote control or the **▲/▼** buttons on the monitor.

Use the **▲/▼** buttons on the remote control or the **+/-** buttons on the monitor to change the sharpness settings. The sharpness of the overall display should be changing accordingly while you are doing this.

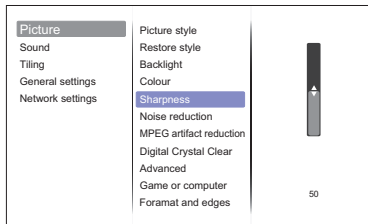

Press the **BACK** button on the remote control or the **MENU** button on the monitor lastly, it ends, all changes are saved in the memory.

NOTE

- The **BACK** button on the remote control or the **INPUT** button on the monitor can be used to return previous menu item.
- Any changes are automatically saved in the memory when the On Screen Monitor disappears. Turning off the power should be avoided while using the Menu.

Direct

* Available for Remote Control only.





Press the ADJUST button when Menu is not displayed.
Direct menu below appears.

- **PC input and Video input (HDMI, DisplayPort, Card OPS, DVI, YPbPr, AV, VGA)**
 - **Sound Style:**
Access predefined sound settings.
 - **Audio out:**
Adjust audio output volume.
 - **Picture format:**
Change the picture format.
 - **Picture shift:**
Move the position of the picture.
- **Video input only (HDMI(Video), YPbPr, AV)**
 - **Picture Style:**
Select a predefined picture settings.

ADJUSTMENT MENU CONTENTS

















Picture

Picture	Picture style	Personal
Sound	Restore style	Vivid
Tiling	Backlight	Natural
General settings	Colour	Standard
Network settings	Sharpness	Movie
	Noise reduction	Photo
	MPEG artifact reduction	Energy saving
	Digital Crystal Clear	
	Advanced	
	Game or computer	
	Format and edges	

Adjustment Item	Problem / Option		Button to Press
Picture style* ¹ Direct	Personal	Displays a picture on a screen set by Image Settings adjustments.	
	Vivid	For displaying outdoor scenery images.	
	Natural	For displaying natural images.	
	Standard	For general windows environment and the monitor default setting.	
	Movie	For movie and video environment.	
	Photo	For photo environment.	
	Energy saving	To display the image while reducing power.	
Restore style	Yes	Picture setting will be restored to factory-preset data.	
	No	Return to Menu.	
Backlight	Brightness of back light is reduced.		
Colour	Too weak		
	Too strong		
Sharpness* ¹	Too soft		
	Too sharp		
Noise reduction* ¹	Off	Noise Reduction is turned off.	
	Minimum	Electronic image noise caused by different media players is reduced.	
	Medium	Electronic image noise caused by different media players is reduced more than Minimum.	
	Maximum	Electronic image noise caused by different media players is reduced more than Medium.	
MPEG artifact reduction	Off	MPEG artifact reduction is turned off.	
	On	Smoothen transitions and haziness in the digital picture.	
Digital Crystal Clear	Advanced sharpness* ¹	Off	Advanced sharpness is turned off.
		On	Enhance the picture edge and lines.

*¹ Only HDMI(Video), YPbPr and AV input.

Picture		
Picture	Picture style	Personal
Sound	Restore style	Vivid
Tiling	Backlight	Natural
General settings	Colour	Standard
Network settings	Sharpness	Movie
	Noise reduction	Photo
	MPEG artifact reduction	Energy saving
	Digital Crystal Clear	
	Advanced	
	Game or computer	
	Format and edges	

Adjustment Item	Problem / Option		Button to Press	
Digital Crystal Clear	Dynamic contrast*1	Off	Dynamic contrast is turned off.	
		LOW	Dynamically enhance the details areas of the picture.	
		MIDDLE	Dynamically enhance the details areas of the picture more than LOW.	
		HIGH	Dynamically enhance the details areas of the picture more than MIDDLE.	
	Colour enhancement*1	Off	Colour enhancement is turned off.	
		LOW	Colour enhancement the vividness and details of colours.	
		MIDDLE	Colour enhancement the vividness and details of colours more than LOW.	
		HIGH	Colour enhancement the vividness and details of colours more than MIDDLE.	
Advanced	Gamma	You can set the Gamma. -4 - +4		
	Tint	Cool	Bluish white	
		Normal	Greenish white	
		Warm	Reddish white	
		Custom	R-WP(Red) G-W(Green) B-WP(Blue)	Too weak   Too strong  
	Video contrast	Too dull		
		Too intense		
	Brightness*2	Too dark		
		Too bright		
	Hue	Purplish		
Greenish				

*1 Only HDMI(Video), YPbPr and AV input.

*2 Adjust the Brightness when you are using the monitor in a dark room and feel the screen is too bright.

Picture









Picture	Picture style	Personal
Sound	Restore style	Vivid
Tiling	Backlight	Natural
General settings	Colour	Standard
Network settings	Sharpness	Movie
	Noise reduction	Photo
	MPEG artifact reduction	Energy saving
	Digital Crystal Clear	
	Advanced	
	Game or computer	
	Format and edges	

Adjustment Item	Problem / Option		Button to Press
Game or computer *3	Off	Game or computer is turned off.	
	Game	Apply the game settings from the game console.	
	Computer	Apply the game settings when have a computer and HDMI connection.	
Format and edges	Picture format Direct	Auto zoom	Enlarges the image on the screen to the original screen ratio.
		Movie expand 16:9	Scale 4:3 format to 16:9. Not recommended for HD or PC.
		Wide screen	Shows widescreen format content stretched. Not recommended for HD or PC.
		Unscaled	Display all pictures in the original resolution.
		4:3	Display all pictures in 4:3 aspect ratio.
	Picture shift	Move the position of the picture.	

*3 This function is available when select the "Unscaled" of "Picture format".

Sound

Picture	Sound style	Personal
Sound	Restore style	Original
Tiling	Bass	Movie
General settings	Treble	Music
Network settings	Balance	Game
	Surround mode	News
	Audio out	
	Advanced	

Adjustment Item	Problem / Option		Button to Press
Sound style Direct	Personal	Recalls customized settings.	
	Original	Set the original sound quality.	
	Movie	Sound quality suitable for the movie.	
	Music	Sound quality suitable for the music.	
	Game	Sound quality suitable for the game.	
	News	Sound quality suitable for the news.	
Restore style	Yes	Sound setting will be restored to factory-preset data.	
	No	Return to Menu.	
Bass	Too weak		
	Too strong		
Treble	Too weak		
	Too strong		
Balance	Too loud sound from the right speaker		
	Too loud sound from the left speaker		
Surround mode	Off	Surround mode is turned off.	
	On	Enhance surround experience.	
Audio out Direct	Adjust audio output volume.		
	Too soft		
	Too loud		
Advanced	Auto volume leveling	Off	Auto volume leveling is turned off.
		On	Enable the reduction of sudden volume changes.
	Speaker settings	Off	Turn Off the internal speaker.
		On	Turn On the internal speaker.
	Clear sound	Off	Clear sound is turned off.
		On	Enable the volume

Tiling *1

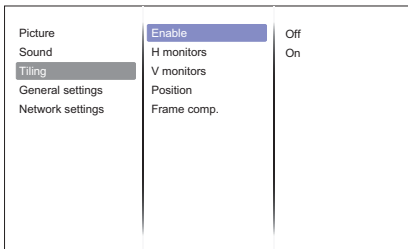

Adjustment Item	Problem / Option		Button to Press
Enable	Off	Enable is turned off.	
	On	The monitor will apply the settings in "H monitors", "V monitors", "Position" and "Frame comp.".	
H monitors	Sets the number of monitors used in the horizontal position.		
V monitors	Sets the number of monitors used in the vertical position.		
Position	Sets the position of the screen matrix.*2		
Frame comp.	Off	Frame comp. is turned off.	
	On	The monitor will adjust the image to compensate for the width of the monitor bezels in order to accurately display the image.	

*1 With this function you can create a single large-screen matrix (video wall) that consists of up to 100 sets of this monitor (up to 10-sets on the vertical and 10-sets on the horizontal sides).

*2 Screen Matrix

Example: 2 x 2 screen matrix (4 monitors)

H monitors = 2 monitors

V monitors = 2 monitors

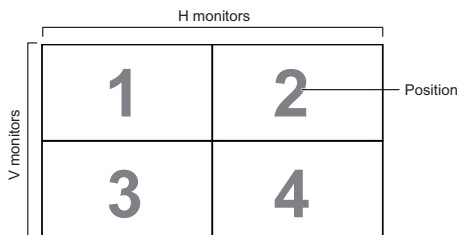

Example: 5 x 5 screen matrix (25 monitors)

H monitors = 5 monitors

V monitors = 5 monitors

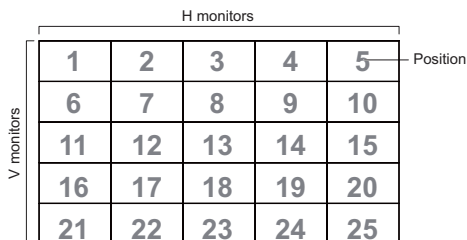

General settings

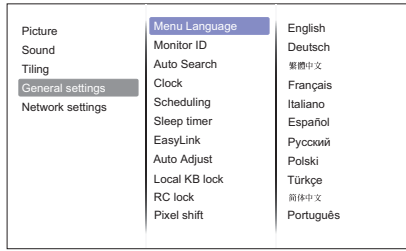

Adjustment Item	Problem / Option		Button to Press	
Menu Language	English	English	Türkçe	Turkish
	Deutsch	German	简体中文	Simplified Chinese
	繁體中文	Traditional Chinese	Português	Portuguese
	Français	French	اللغة العربية	Arabic
	Italiano	Italian	日本語	Japanese
	Español	Spanish	Nederlands	Dutch
	Русский	Russian	Česky	Czech
	Polski	Polish		
Monitor ID	Set ID to the monitor. 1 - 255			
Auto Search	Status	Off	Auto Search is turned off.	
		On	Automatically detects available input sources.	
		Failover	Set the input source to detect with priority.	
Clock	Adjust the current date and time for the internal clock. Daylight saving(Daylight saving time/Standard time)/Date/Time NOTE You must set this item when using "Scheduling".			
Scheduling	Schedule1 Schedule2 Schedule3 Schedule4 Schedule5 Schedule6 Schedule7	Status	Off	Schedule is turned off.
			On	Schedule is turned on.
		Source	Select default input source to use when the monitor is automatically turned on next time. USB/HDMI/DVI/YPbPr/AV/VGA	
		On Time Off Time	Set the time for the monitor to turn on and turn off.	
		Repeat modes	Sets a recurring schedule. No Repeat / Every Sunday / Every Monday / Every Tuesday / Every Wednesday / Every Thursday / Every Friday / Every Saturday	
		Playlist setting	Set the file to be started when the power is turned on. Press the red button on the remote control after choosing a file and then select and save the "Save list" 30 files support.	
Sleep timer	Switch off this monitor after a specified time. 0 - 180 mins			
EasyLink	Off	EasyLink is turned off.		
	On	Connect and control your HDMI-CEC compliant devices through HDMI port to this monitor with the same remote control.		

General settings

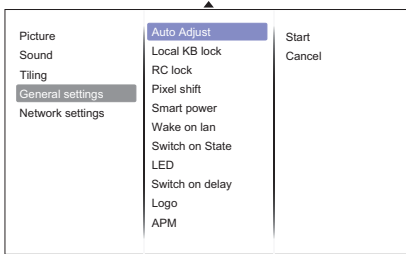

Adjustment Item	Problem / Option		Button to Press
Auto adjust * ¹	Start	Adjust H. / V. Position, Clock and Phase automatically.	
	Cancel	Return to Menu.	
Local KB lock * ²	Choose to enable or disable the back controller function of this display.		
	Unlock	Enable the button function.	
	Lock all	Lock all the button function.	
	Lock but volume	Disable all the button function except the VOL+ and VOL- button.	
	Lock but power	Disable all the button function except the Power button.	
	Lock all expect volume and power	Disable all the button function except the VOL+, VOL- and Power button.	
RC lock * ²	Choose to enable or disable the button function of the remote control.		
	Unlock	Enable the button function.	
	Lock all	Lock all the button function.	
	Lock but volume	Disable all the button function except the VOL+ and VOL- button.	
	Lock but power	Disable all the button function except the Power button.	
	Lock all expect volume and power	Disable all the button function except the VOL+, VOL- and Power button.	
Pixel shift * ³	Off	Pixel shift is turned off.	
	On	Move the screen image automatically to protect the monitor from "burn-in" or "after-image" symptoms If not operating even 30 seconds.	
Smart power* ³	Off	Dynamic backlight is turned off.	
	Standard	Optimize dynamic power consumption and picture contrast.	
	Best Power	Optimize dynamic power consumption.	
	Best Picture	Optimize dynamic picture contrast.	
Wake on lan	Off	Wake on lan is turned off.	
	On	Turn the monitor on remotely over LAN network.	

*¹ Only VGA input.

*² To disable the lock function from "Local KB lock" or "RC lock" item, press  HOME button and 1998 on the remote control.

*³ Only HDMI(Video), YPbPr and AV input.

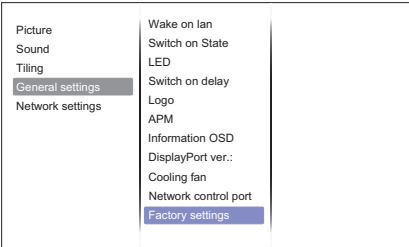
General settings			
			
Adjustment Item	Problem / Option		Button to Press
Switch on state	On	The monitor will turn on when the power cable is connected to a wall outlet.	
	Standby	The monitor will remain standby when the power cable is connected to a wall outlet.	
	Last status	The monitor will return to the previous power status (On/Off/Standby) when removing and replacing the power cable.	
LED	Off	The power indicator is turned off.	
	On	The power indicator is turned on.	
Switch on delay	Adjust the power-on delaying time (in seconds) allows a sequential powering-on for each monitor by their ID number when multiple monitors are connected. 0 - 60 seconds		
Logo	Off	iiyama Logo does not display when the monitor is turned on.	
	On	iiyama Logo displayed when the monitor is turned on.	
APM	Off	APM is turned off.	
	On	When there is no signal, the monitor will automatically turn off.	
Information OSD	Off	Information OSD is turned off.	
	On	When you press the Power button turn on the monitor from standby mode or change the input signal. The information OSD is displayed on the upper left corner of the screen.	
DisplayPort Ver.	Set the version of the DisplayPort. 1.1a/1.2		
Cooling fan	Off	The Cooling fan is turned off.	
	On	The Cooling fan is turned on.	
	Auto	The fan turns on automatically when the monitor's internal temperature reaches 60°C or higher.	
Network control port	RS232C	When the RS232C is being used.	
	Card OPS RS232C	To use when inserting a computer to the OPS.	
Factory settings	OK	Factory-preset data is restored.	
	Cancel	Return to Menu.	

<Auto Wake Up Function within ECO mode setting>

Press successively following buttons on the remote control when the Menu is not displayed.

▲ → ▼ → ◀ → ▶ → OK → MENU

Eco mode is then displayed under "General settings".

Eco mode : Normal / Low power standby

● APM and Eco mode setting

APM	Eco mode	Monitor status	Power Indicator	Remark
On	Normal	Standby mode	Green blinking	When re-plug the signal cable, the monitor will wake up automatically.
	Low power standby	Power off	Amber (Green+Red)	When re-plug the signal cable, the monitor will not wake up automatically. Need press the remote control or power button of the monitor to power on.

NOTE Default setting for Eco mode is "Low power standby", if settings were manually changed and a "Factory settings" is performed, settings will not change back to Default. However, settings can still change manually to "Low power standby".

Network Settings

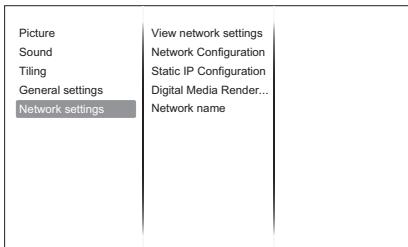

Adjustment Item	Problem / Option		Button to Press
View network settings	View connected network status.		
Network Configuration	Select how this display should assign addresses to the network resources. DHCP & Auto IP / Static IP		
Static IP Configuration	Assign {IP address}, {Netmask}, {Gateway}, {DNS1}, and {DNS2} for this display.		
Digital Media Renderer - DMR	Off	Digital Media Renderer - DMR is turned off.	
	On	Receive multimedia files from Smart phones or Tablets connected to your network.	
Network name	Rename this monitor for easy identification.		

[Play Multimedia Files]

You can play videos, photos, and music on your monitor from:

- Your computer connected through your network.
- A USB device connected to this monitor.

● Play files from computer via local Area Network

To play files from computer via local Area Network, you will need:

- A wired network, connected with a Universal Plug and Play (uPnP) router.
- Optional: A LAN cable that connects your monitor to your network.
- A media server running on your computer.
- Appropriate settings on your computer firewall to allow you to run the media server.



■ Set up media sharing

1. Install a media server on your computer to share media files. These are some media servers:
 - For PC: Windows Media Player 11 (or higher) or TVersity
 - For Mac: Twonky
2. Switch on media sharing on your computer using the media server. For more information on how to set up the media server, refer to the website of the media server.

■ How to use DNLA-DMP

1. Connect monitor and your computer to the same router via RJ45.
2. Run windows media player. Set stream handling as public sharing.



■ Play files from monitor

1. Press  SOURCE button, select [Network] and press OK button.
2. Now, you can see all the computer's connected to the same router on the screen. Select the right one.
3. Press  and  to select the directory and files to play.

NOTE

We suggest to use DLNA-DMP function via wired network for the sake of higher security and sufficient network bandwidth.

■ How to use DNLA-DMR from computer

1. Press  HOME button, select [Network settings] and press OK button.
2. Set DMR as [On].
3. Set the name of your monitor.
4. Press  SOURCE button, select [Network] and press OK button.
5. On your computer, go to [Network and Sharing Center], and click [Choose homegroup and sharing options].
6. Check the media formats. Then, click [Choose media streaming options...].
7. Go to [Advanced sharing settings], and check [Turn on network discovery].
8. Now, go to the directory of your media files. Select the media file by right click. On the submenu from Play To, you can find all monitors connected to your network, select the monitor, and click the media file to play.





■ Play files

1. Press  SOURCE button.
2. Select [Network], then press OK button.
3. Select a file from the content browser, then press OK button to start playing.
4. Press the Play buttons on the remote control to control playing.







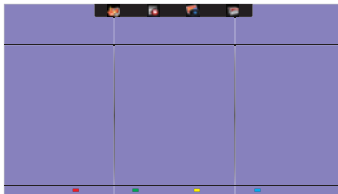

- * • Select the top bar to filter our files by type.
- Select [Sort] to arrange the files by album name, artist, or other fields.
- To clear the list of offline media servers, press  OPTIONS button. Then, select [Clear offline servers] and press OK button.

● Play multimedia files from USB device

This monitor can play music, movie, or photo files from your USB device.

1. Connect your USB device to the USB port on this monitor.
2. Press  SOURCE button, select USB, then press OK button.
3. The connected USB device is detected automatically for all its playable files which will be automatically sorted into 3 types:  Music,  Movie and  Photo.



4. Press the  BACK button to go up to the top layer in the screen. Press  or  button to select the file type. Press OK button to enter its play list.
5. Select the file you want. Press OK button to start playing.
6. Follow the on-screen instruction to control the play option.
7. Press the PLAY buttons (, , , , , ) to control playing.

■ USB Standard:

USB2.0

NOTE The USB 2.0 compatibility is always granted. The USB 3.0 high speed support cannot be guaranteed with all devices.

■ Supported file system:

FAT32

■ Supported file format:

- Music: MP3, WMA, M4A, AAC, AC3
- Movie: AVI, MP4, MOV, MPG/MPEG
- Photo: JPEG, BMP, GIF

CAUTION

- The manufacturer is not responsible if the USB device is not supported, nor is it responsible for damage to or loss of data in the device.
- Do not overload the USB port. If you connect a USB storage device that consumes more than 500mA power, make sure that it is connected to its own external power supply.

NOTE







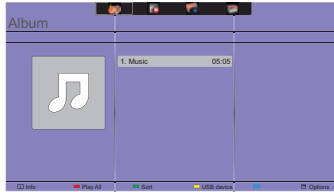

When you are playing multimedia files from USB device and turn the monitor off. It will set input source to the last real input source, such as HDMI, DVI, YPbPr, AV and VGA when you turn the monitor on next time.

[Play options]

● Playing music files

1. Select  Music in the top bar.
2. Select one music track, then press OK button.



3. Press the  BACK button to display the play menu.
 - Play All : To play all the tracks in a folder.
 - Sort : It classifies the track.
 - USB device : Music list of the USB device will be displayed.
 -  /  : To skip to the next or previous track.
 - OK : To pause the track or resume.
 -  /  : To skip backward or forward 10 seconds.
 -  /  : To search backward or forward. Press repeatedly to toggle between different speeds.
 -  : To stop the music.

■ Music options

While playing music, press  OPTIONS button.



<Option>



- Repeat : To play a track or an album repeatedly.
- Play once : To play a track once.
- Shuffle On / Shuffle Off : Enable or disable random play of tracks.

<Eco>

Turn off the screen to save power consumption. To display again, press any button on the remote control.

NOTE

To view information about a song (for example, title, artist or duration), select the song, press the  BACK button to display the play menu and then press the  INFO button. To hide the information, press the  INFO button again.

After pressing the OK button to select a song, the menu screen disappears when the  INFO button is selected again. When press the  BACK button to display the menu screen.

■ Play photo files from music file menu

While playing a music file, press the  BACK button, go to the top of the screen, select a picture and then select slide show.

● Playing movie files

1. Select  Movie in the top bar.
2. Select a video, then press OK button.

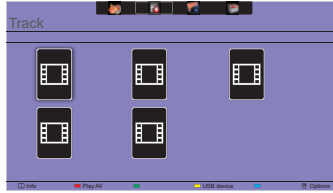

- Play All : To play all the videos in a folder.
- Sort : It classifies the movie.
- USB device : Movie list of the USB device will be displayed.
- OK : To pause the video or resume.
- ◀ / ▶ : To skip backward or forward 10 seconds.
- ◀◀ / ▶▶ : To search backward or forward. Press repeatedly to toggle between different speeds.
- ■ : To stop the video.

■ Movie options

While playing video, press  OPTIONS button.

<Option>

- Subtitles : Select the available subtitle settings.
- Subtitles On / Off : Subtitle display on / off.
- On During Mute : Enable the subtitle display.
Subtitle can be switched on/off by pressing the Mute button.
- Subtitle Language : Select the language for subtitles if available.
- Shuffle On / Shuffle Off : Enable or disable random play of video files.
- Repeat : To play the video file repeatedly.
- Play once : To play the video file once.
- Status : Displays video information.

<Picture and Sound>

- Picture Mode / Sound Mode / Audio out / Picture Format

<Eco>

Turn off the screen to save power consumption. To display again, press any button on the remote control.

<Clock>

- Sleep timer

● Playing photo files

1. Select  Photo in the top bar.
2. Select a photo thumbnail, then press OK button.

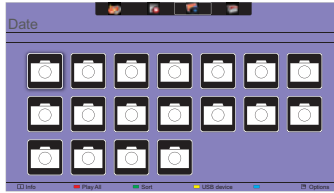

■ Start a slideshow

- Play All : To play all the photo in a folder. (multiple photo)
- Sort : It classifies the photo.
- USB device : Photo list of the USB device will be displayed.
- ◀ / ▶ : To skip to the previous or next photo, then press OK button at the end.
- ■ : To stop the slideshow.

■ Slideshow options

While you play a slideshow, press  OPTIONS button.

<Option>

- Shuffle On / Shuffle Off : Enable or disable random picture in the slideshow.
- Repeat : To watch a slideshow.
- Play once : To watch once.
- Slideshow Time : Select the displaying time for each photo in the slideshow.
- Slideshow Transitions : Select the transition from one photo to the next.

<Picture and Sound>

- Picture Mode / Sound Mode / Audio out / Picture Format

<Eco>

Turn off the screen to save power consumption. To display again, press any button on the remote control.

● Folder

It lists the files in the USB device. It is possible to play directly from the USB.

POWER MANAGEMENT FEATURE

The power management feature of this product complies with power saving requirement of VESA DPMS. When activated, it automatically reduces unnecessary power consumption of the monitor when your computer is not in use.

To use the feature, the monitor needs to be connected to a VESA DPMS compliant computer. There is a power management step the monitor takes as described below. The power management function, including any timer settings is configured by the operating system. Check your operating system manual for information on how this can be configured.

■ Power Management Mode

When the H-sync signal / V-sync signal / H and V sync signals from the computer are off, the monitor enters into Power Management Mode which reduces the power consumption to less than 0.5W. The screen becomes dark. From Power Management Mode, the image reappears in several seconds when either the keyboard or the mouse are touched again.

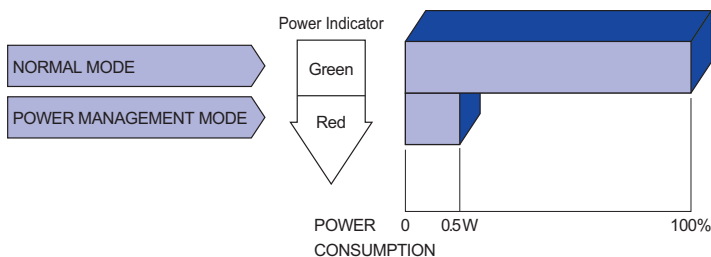

NOTE

- Even when using the power management mode, the monitor consumes electricity. Turn off the Power Switch whenever the monitor is not in use, during the night and weekends, to avoid unnecessary power consumption.
- It is possible that the video signal from the computer may be on while the H or V sync signal is missing. In this instance, the POWER MANAGEMENT feature may not work properly.

TROUBLE SHOOTING

If the monitor fails to operate correctly, please follow the steps below for a possible solution.

1. Perform the adjustments described in OPERATING THE MONITOR, depending on the problem you have. If the monitor does not get a picture, skip to 2.
2. Consult the following items if you cannot find an appropriate adjustment item in OPERATING THE MONITOR or if the problem persists.
3. If you are experiencing a problem which is not described below or you cannot correct the problem, discontinue using the monitor and contact your dealer or iiyama service center for further assistance.

Problem

Check

- | | |
|---|--|
| ① The picture does not appear. | <input type="checkbox"/> The Power Cable is firmly seated in the socket.
<input type="checkbox"/> The Power Switch is turned ON.
<input type="checkbox"/> The AC socket is live. Please check with another piece of equipment.
<input type="checkbox"/> If the blank screen saver is in active mode, touch the keyboard or the mouse.
<input type="checkbox"/> Increase the Contrast and/or Brightness.
<input type="checkbox"/> The computer is ON.
<input type="checkbox"/> The Signal Cable is properly connected.
<input type="checkbox"/> The signal timing of the computer is within the specification of the monitor.
<input type="checkbox"/> If the monitor is in power management mode, touch the keyboard or the mouse. |
| ② The screen is not synchronized. | <input type="checkbox"/> The Signal Cable is properly connected.
<input type="checkbox"/> The signal timing of the computer is within the specification of the monitor.
<input type="checkbox"/> The video output level of the computer is within the specification of the monitor. |
| ③ The screen position is not in the center. | <input type="checkbox"/> The signal timing of the computer is within the specification of the monitor. |
| ④ The screen is too bright or too dark. | <input type="checkbox"/> The video output level of the computer is within the specification of the monitor. |
| ⑤ The screen is shaking. | <input type="checkbox"/> The power voltage is within the specification of the monitor.
<input type="checkbox"/> The signal timing of the computer is within the specification of the monitor. |
| ⑥ No sound. | <input type="checkbox"/> The audio equipment (computer etc.) is ON.
<input type="checkbox"/> The Audio Cable is properly connected.
<input type="checkbox"/> The Volume is turned up.
<input type="checkbox"/> The Mute is OFF.
<input type="checkbox"/> The audio output level of the audio equipment is within the specification of the monitor. |
| ⑦ The sound is too loud or too quiet. | <input type="checkbox"/> The audio output level of the audio equipment is within the specification of the monitor. |
| ⑧ A strange noise is heard. | <input type="checkbox"/> The Audio Cable is properly connected. |

RECYCLING INFORMATION

For better environment protection please don't dispose your monitor.
Please visit our web site: www.iiyama.com/recycle for monitor recycling.

APPENDIX

Design and specifications are subject to change without prior notice.

SPECIFICATIONS : ProLite LH4282SB

ENGLISH

Size Category	42"	
LCD Panel	Panel technology	IPS
	Size	Diagonal: 41.9" (106.5cm)
	Pixel pitch	0.4833mm H × 0.4833mm V
	Brightness	700cd/m ² (Typical)
	Contrast ratio	1300 : 1 (Typical)
	Viewable angle	Horizontal : 178 degrees, Vertical: 178 degrees (Typical)
	Response time	8ms (Typical, Gray to Gray)
Display Colors	Approx. 1.07B	
Sync Frequency	Analog: Horizontal: 30.0-83.0kHz, Vertical: 50-76Hz Digital: Horizontal: 30.0-83.0kHz, Vertical: 50-76Hz	
Maximum Resolution	1920 × 1080, 2.1 MegaPixels	
Input Connector	VGA, DVI-D, HDMIx2, DisplayPort	
Input Audio Connector	mini jack, RCA (L/R)	
Input Component Connector	RCA (Video/L/R)	
LAN	RJ45	
Serial Port	RS-232C In/Out mini jack	
Plug & Play	VESA DDC2B™	
Input Sync Signal	Separate sync: TTL, Positive or Negative	
Input Video Signal	Analog: 0.7Vp-p (Standard), 75Ω, Positive Digital: DVI (Digital Visual Interface Standard Rev.1.0) compliance Digital: HDMI, DisplayPort	
Input Audio Signal	0.5Vrms maximum	
IR Extender Connector	IR In/Out	
USB Connector	USB2.0 (USB Media Player)	
Output Connector	DVI-D, DisplayPort	
Headphone Connector	RCA(L/R)	
Speakers	Internal: 10W×2 (Stereo speakers), External (speaker jack): 10W×2	
Maximum Screen Size	927.94mm W × 521.96mm H / 36.5" W × 20.5" H	
Power Source	100-240VAC, 50/60Hz, 2.5A	
Power Consumption*	114W typical, Power management mode: 0.5W maximum Energy Efficiency Class: C	
Dimensions / Net Weight	947.0 × 541.0 × 71.0mm / 37.3× 21.3 × 2.8" (W×H×D) 15.3kg / 33.7lbs	
Environmental Considerations	Operating: Temperature 0 to 40°C / 32 to 104°F Humidity 20 - 80% (No condensation) Storage: Temperature -20 to 60°C / 4 to 140°F Humidity 5 - 95% (No condensation)	
Approvals	CB, CE, CU, TÜV-Bauart	

NOTE * Audio equipment are not connected.

SPECIFICATIONS : ProLite LH4982SB

Size Category	49"	
LCD Panel	Panel technology	IPS
	Size	Diagonal: 48.5" (123.2cm)
	Pixel pitch	0.55926mm H × 0.55926mm V
	Brightness	700cd/m ² (Typical)
	Contrast ratio	1300 : 1 (Typical)
	Viewable angle	Horizontal : 178 degrees, Vertical: 178 degrees (Typical)
	Response time	8ms (Typical, Gray to Gray)
Display Colors	Approx.1.07B	
Sync Frequency	Analog: Horizontal: 30.0-83.0kHz, Vertical: 50-76Hz Digital: Horizontal: 30.0-83.0kHz, Vertical: 50-76Hz	
Maximum Resolution	1920 × 1080, 2.1 MegaPixels	
Input Connector	VGA, DVI-D, HDMIx2, DisplayPort	
Input Audio Connector	mini jack, RCA (L/R)	
Input Component Connector	RCA (Video/L/R)	
LAN	RJ45	
Serial Port	RS-232C In/Out mini jack	
Plug & Play	VESA DDC2B™	
Input Sync Signal	Separate sync: TTL, Positive or Negative	
Input Video Signal	Analog: 0.7Vp-p (Standard), 75Ω, Positive Digital: DVI (Digital Visual Interface Standard Rev.1.0) compliance Digital: HDMI, DisplayPort	
Input Audio Signal	0.5Vrms maximum	
IR Extender Connector	IR In/Out	
USB Connector	USB2.0 (USB Media Player)	
Output Connector	DVI-D, DisplayPort	
Headphone Connector	RCA(L/R)	
Speakers	Internal: 10W×2 (Stereo speakers), External (speaker jack): 10W×2	
Maximum Screen Size	1073.8mm W × 604.0mm H / 42.3" W × 23.8" H	
Power Source	100-240VAC, 50/60Hz, 2.5A	
Power Consumption*	135W typical, Power management mode: 0.5W maximum Energy Efficiency Class: C	
Dimensions / Net Weight	1093.0 × 623.0 × 71.0mm / 43.0 × 24.5 × 2.8" (W×H×D) 19.0kg / 41.9lbs	
Environmental Considerations	Operating:	Temperature 0 to 40°C / 32 to 104°F Humidity 20 - 80% (No condensation)
	Storage:	Temperature -20 to 60°C / 4 to 140°F Humidity 5 - 95% (No condensation)
Approvals	CB, CE, CU, TÜV-Bauart	

NOTE * Audio equipment are not connected.

SPECIFICATIONS : ProLite LH5582SB

ENGLISH

Size Category	55"	
LCD Panel	Panel technology	IPS
	Size	Diagonal: 54.6" (138.8cm)
	Pixel pitch	0.63mm H × 0.63mm V
	Brightness	700cd/m ² (Typical)
	Contrast ratio	1300 : 1 (Typical)
	Viewable angle	Horizontal : 178 degrees, Vertical: 178 degrees (Typical)
	Response time	8ms (Typical, Gray to Gray)
Display Colors	Approx. 1.07B	
Sync Frequency	Analog: Horizontal: 30.0-83.0kHz, Vertical: 50-76Hz Digital: Horizontal: 30.0-83.0kHz, Vertical: 50-76Hz	
Maximum Resolution	1920 × 1080, 2.1 MegaPixels	
Input Connector	VGA, DVI-D, HDMIx2, DisplayPort	
Input Audio Connector	mini jack, RCA (L/R)	
Input Component Connector	RCA (Video/L/R)	
LAN	RJ45	
Serial Port	RS-232C In/Out mini jack	
Plug & Play	VESA DDC2B™	
Input Sync Signal	Separate sync: TTL, Positive or Negative	
Input Video Signal	Analog: 0.7Vp-p (Standard), 75Ω, Positive Digital: DVI (Digital Visual Interface Standard Rev.1.0) compliance Digital: HDMI, DisplayPort	
Input Audio Signal	0.5Vrms maximum	
IR Extender Connector	IR In/Out	
USB Connector	USB2.0 (USB Media Player)	
Output Connector	DVI-D, DisplayPort	
Headphone Connector	RCA(L/R)	
Speakers	Internal: 10W×2 (Stereo speakers), External (speaker jack): 10W×2	
Maximum Screen Size	1209.6mm W × 680.4mm H / 47.6" W × 26.8" H	
Power Source	100-240VAC, 50/60Hz, 2.5A	
Power Consumption*	146W typical, Power management mode: 0.5W maximum Energy Efficiency Class: B	
Dimensions / Net Weight	1228.5 × 699.5 × 71.0mm / 48.4 × 27.5 × 2.8" (W×H×D) 24.7kg / 54.4lbs	
Environmental Considerations	Operating: Temperature 0 to 40°C / 32 to 104°F Humidity 20 - 80% (No condensation) Storage: Temperature -20 to 60°C / 4 to 140°F Humidity 5 - 95% (No condensation)	
Approvals	CB, CE, CU, TÜV-Bauart	

NOTE * Audio equipment are not connected.

DIMENSIONS : ProLite LH4282SB

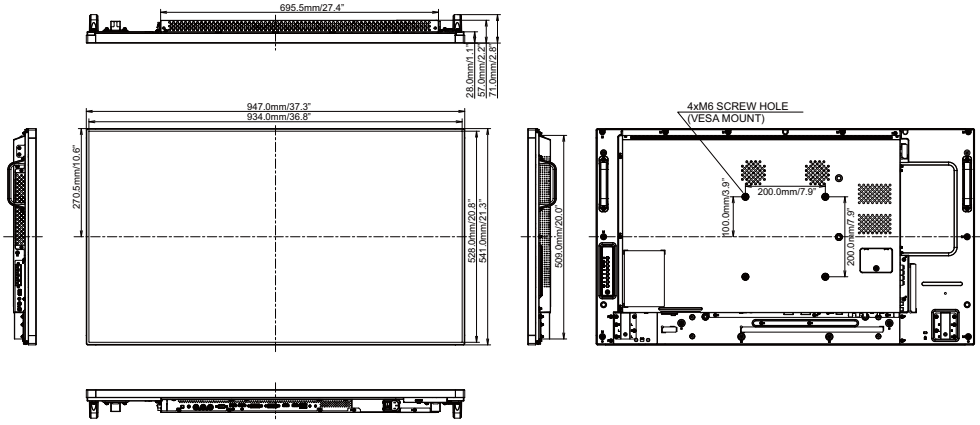

DIMENSIONS : ProLite LH4982SB

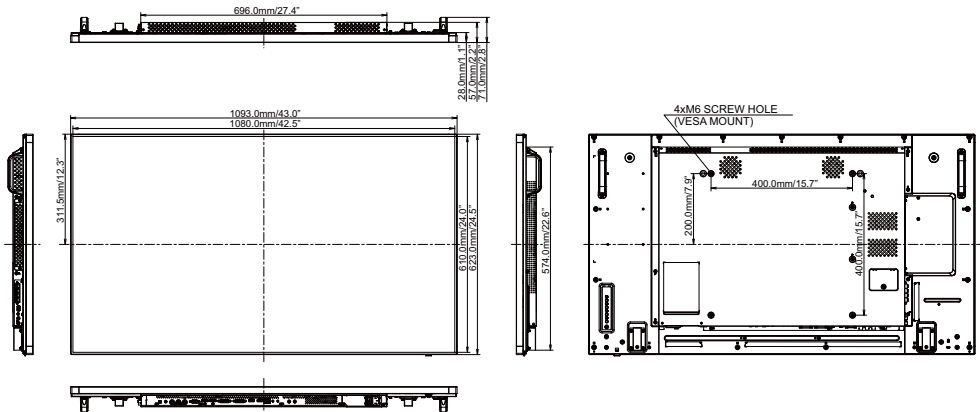

DIMENSIONS : ProLite LH5582SB

ENGLISH

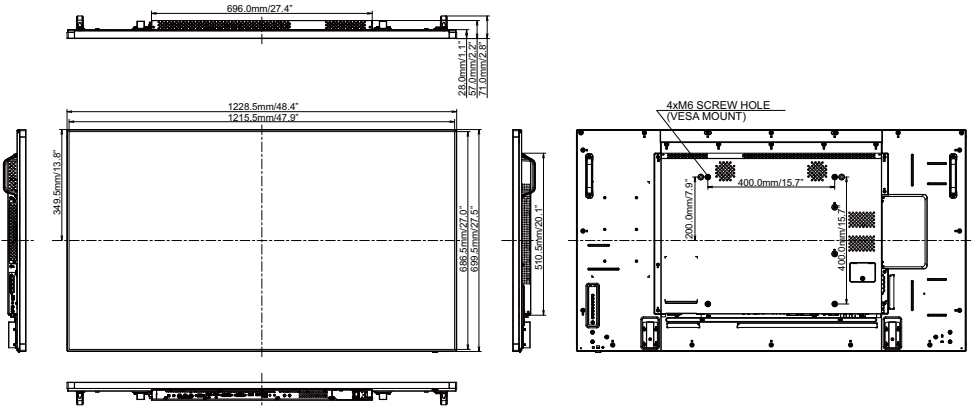

COMPLIANT TIMING

Timing		fH(kHz)	fV(Hz)	Dot clock (MHz)	VGA	DVI	HDMI	YPbPr	AV	
VESA	VGA 640x480	31.469	59.940	25.175	○	○	○			
		37.861	72.809	31.500	○	○	○			
		37.500	75.000	31.500	○	○	○			
	SVGA 800x600	37.879	60.317	40.000	○	○	○			
		46.875	75.000	49.500	○	○	○			
		48.363	60.004	65.000	○	○	○			
	XGA 1024x768	60.023	75.029	78.750	○	○	○			
		47.776	59.870	79.500	○	○	○			
	WXGA 1280x768	49.702	59.810	83.500	○	○	○			
	SXGA 1280x960	60.000	60.000	108.000	○	○	○			
	SXGA 1280x1024	63.981	60.020	108.000	○	○	○			
	WXGA1360x768	47.712	60.020	85.500	○	○	○			
WXGA1366x768	47.712	59.700	85.500	○	○	○				
UXGA 1600x1200	75.000	60.000	162.000	○	○	○				
FHD 1920x1080	67.500	60.000	148.500	○	○	○				
IBM	720x400	31.467	70.080	28.320	○	○	○			
MAC	640x480	35.000	66.667	30.240	○	○	○			
	832x624	49.725	74.500	57.283	○	○	○			
SD	1152x870	68.681	75.062	100.000	○	○	○			
	NTSC(SD480i)	15.734	59.940	13.500					○	
	PAL(SD576i)	15.625	59.940	13.500					○	
	SECAM(SD576i)	15.625	59.940	13.500					○	
	480i	60Hz	15.734	59.940	27.000		○	○	○	
		50Hz	15.625	50.000	13.500		○	○	○	
	480p	60Hz	31.469	59.940	27.000		○	○	○	
		50Hz	31.250	50.000	27.000		○	○	○	
HD	720p	50Hz	37.500	50.000	27.000		○	○	○	
		60Hz	45.000	60.000	74.250		○	○	○	
	1080i	50Hz	28.125	50.000	74.250		○	○	○	
		60Hz	33.716	60.000	74.250		○	○	○	
	1080p	50Hz	56.250	50.000	148.500		○	○	○	
		60Hz	67.500	60.000	148.500		○	○	○	

* ○ means supported the timing.