

STIGA[®]

- IT** **Motosega a catena elettrica portatile - MANUALE DI ISTRUZIONI**
ATTENZIONE: prima di usare la macchina, leggere attentamente il presente libretto.
- BG** **Преносим електрически моторен верижен трион**
УПЪТВАНЕ ЗА УПОТРЕБА - ВНИМАНИЕ: преди да използвате машината прочетете внимателно настоящата книжка.
- CS** **Přenosná elektrická řetězová motorová pila - NÁVOD K POUŽITÍ**
UPOZORNĚNÍ: před použitím stroje si pozorně přečtěte tento návod k použití.
- DA** **Værbar elektrisk kædesav - BRUGSANVISNING**
ADVARSEL: læs instruktionsbogen omhyggeligt igennem, før du tager denne maskine i brug.
- DE** **Tragbare elektrische Kettensäge - GEBRAUCHSANWEISUNG**
ACHTUNG: vor Inbetriebnahme des Geräts die Gebrauchsanleitung aufmerksam lesen.
- EL** **Φορητό ηλεκτρικό αλυσοπρίοιο - ΟΔΗΓΙΕΣ ΧΡΗΣΗΣ**
ΠΡΟΣΟΧΗ: πριν χρησιμοποιήσετε το μηχάνημα, διαβάστε προσεκτικά το παρόν εγχειρίδιο.
- EN** **Portable electric chain saw - OPERATOR'S MANUAL**
WARNING: read thoroughly the instruction booklet before using the machine.
- ES** **Motosierra de cadena eléctrica portátil - MANUAL DE INSTRUCCIONES**
ATENCIÓN: antes de utilizar la máquina, leer atentamente el presente manual.
- ET** **Kaasaskantav elektriline kettsaag - KASUTUSJUHEND**
TÄHELEPANU: enne masina kasutamist lugeda tähelepanelikult antud kasutusjuhendit.
- FI** **Käsin kannateltava sähkökäyttöinen moottorisaha - KÄYTTÖOHJEET**
VAROITUS: lue käyttöopas huolellisesti ennen koneen käyttöä.
- FR** **Scie à chaîne électrique et portative - MANUEL D'UTILISATION**
ATTENTION: lire attentivement le manuel avant d'utiliser cette machine.
- HR** **Prijenosna električna lančana pila - PRIRUČNIK ZA UPORABU**
POZOR: prije uporabe stroja, pažljivo pročitaite ovaj priručnik.
- HU** **Hordozható elektromos láncfűrész - HASZNÁLATI UTASÍTÁS**
FIGYELEM! a gép használatá előtt olvassa el figyelmesen a jelen kézikönyvet.
- LT** **Nešiojamas elektrinis grandininis pjūklas - NAUDOJIMO INSTRUKCIJOS**
DĖMESIO: prieš naudojant įrenginį, atidžiai perskaityti šį naudotojo vadovą.
- LV** **Portatīvs elektriskais ķēdes zāģis - LIETOŠANAS INSTRUKCIJA**
UZMANĪBU: pirms aparāta lietošanai rūpīgi izlasiet doto instrukciju.
- MK** **Електрична преносна моторна пила - УПАТСТВА ЗА УПОТРЕБА**
ВНИМАНИЕ: прочитајте го внимателно ова упатство пред да ја користите машината.
- NL** **Draagbare elektrische kettingzaag - GEBRUIKERSHANDLEIDING**
LET OP: vooraleer de machine te gebruiken, dient men deze handleiding aandachtig te lezen.
- NO** **Værbar elektrisk drevet kjedesag - INSTRUKSJONSBOK**
ADVARSEL: les denne bruksanvisningen nøye før du bruker maskinen.
- PL** **Przenośna pilarka łańcuchowa elektryczna - INSTRUKCJE OBSŁUGI**
OSTRZEŻENIE: przed użyciem maszyny, należy uważnie przeczytać niniejszą instrukcję.
- PT** **Motoserra eléctrica portátil - MANUAL DE INSTRUÇÕES**
ATENÇÃO: antes de usar a máquina, leia atentamente o presente manual.
- RO** **Ferăstrău electric cu lanț portabil - MANUAL DE INSTRUCȚIUNI**
ATENȚIE: înainte de a utiliza mașina, citiți cu atenție manualul de față.
- RU** **Портативная электрическая цепная пила**
РУКОВОДСТВО ПО ЭКСПЛУАТАЦИИ - ВНИМАНИЕ: прежде чем пользоваться оборудованием, внимательно прочтите это руководство по эксплуатации.
- SL** **Prenosna električna verižna žaga - PRIROČNIK ZA UPORABO**
POZOR: preden uporabite stroj, pazljivo preberite priročnik z navodili.
- SV** **Eldriven bärbar kedjesåg - BRUKSANVISNING**
VARNING: läs igenom hela detta häfte innan du använder maskinen.
- TR** **Elektrikli taşınabilir zincirli testere - KULLANIM KILAVUZU**
DİKKAT: makineyi kullanmadan önce talimatlar içeren kilavuzu dikkatle okuyun.

ITALIANO - Istruzioni Originali	IT
БЪЛГАРСКИ - Инструкция за експлоатация	BG
ČESKY - Překlad původního návodu k používání	CS
DANSK - Oversættelse af den originale brugsanvisning	DA
DEUTSCH - Übersetzung der Originalbetriebsanleitung	DE
ΕΛΛΗΝΙΚΑ - Μετάφραση των πρωτοτυπων οδηγιων	EL
ENGLISH - Translation of the original instruction	EN
ESPAÑOL - Traducción del Manual Original	ES
EESTI - Algupärase kasutusjuhendi tõlge	ET
SUOMI - Alkuperäisten ohjeiden käännös	FI
FRANÇAIS - Traduction de la notice originale	FR
HRVATSKI - Prijevod originalnih uputa	HR
MAGYAR - Eredeti használati utasítás fordítása	HU
LIETUVIŠKAI - Originalių instrukcijų vertimas	LT
LATVIEŠU - Instrukciju tulkojums no oriģināl valodas	LV
МАКЕДОНСКИ - Превод на оригиналните упатства	MK
NEDERLANDS - Vertaling van de oorspronkelijke gebruiksaanwijzing	NL
NORSK - Oversettelse av den originale bruksanvisningen	NO
POLSKI - Tłumaczenie instrukcji oryginalnej	PL
PORTUGUÊS - Tradução do manual original	PT
ROMÂN - Traducerea manualului fabricantului	RO
РУССКИЙ - Перевод оригинальных инструкций	RU
SLOVENŠČINA - Prevod izvirnih navodil	SL
SVENSKA - Översättning av bruksanvisning i original	SV
TÜRKÇE - Orijinal Talimatların Tercümesi	TR

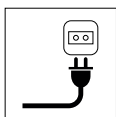

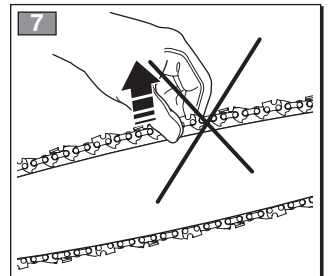
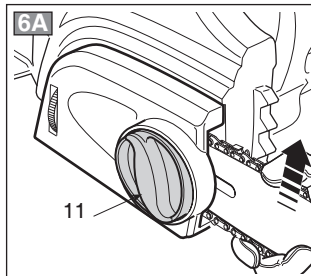
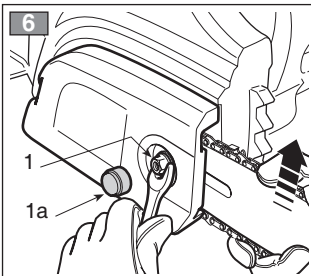
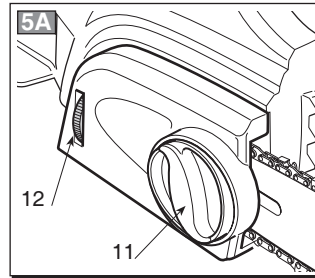
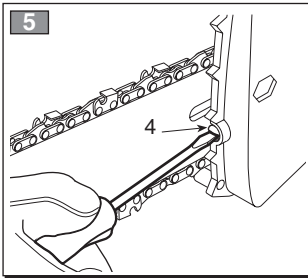
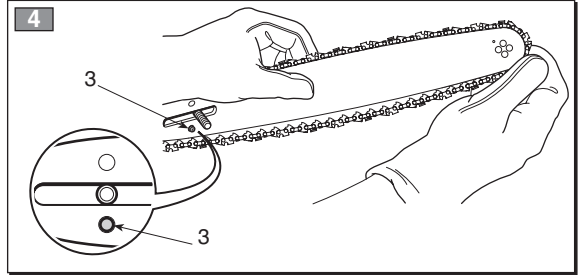
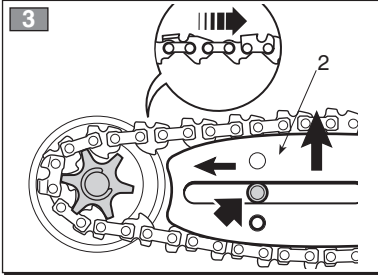
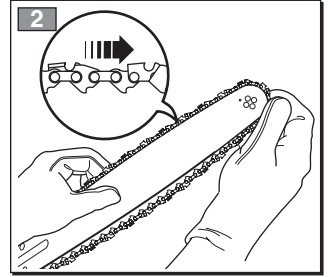
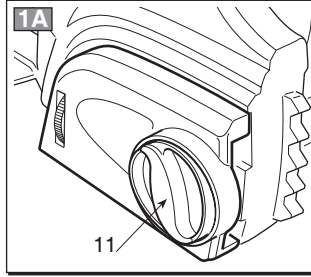
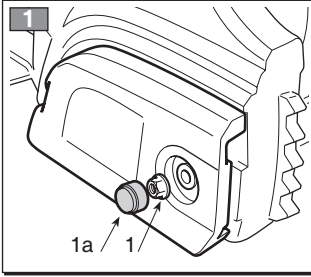
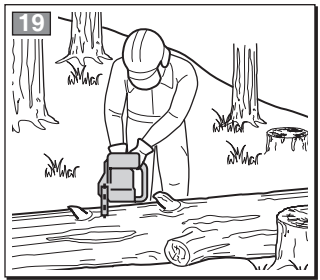
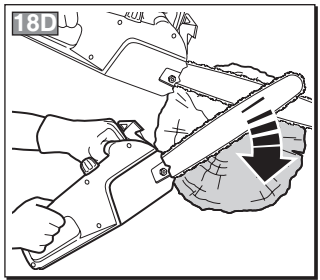
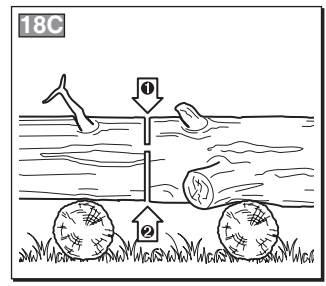
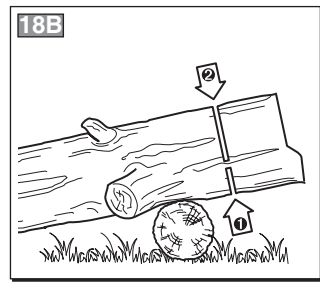
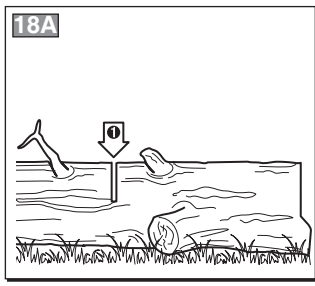
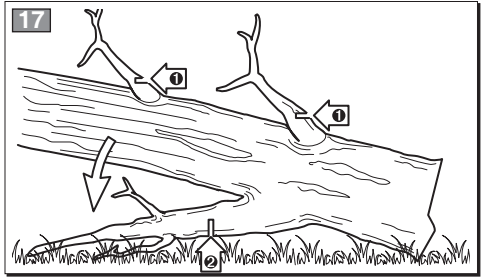
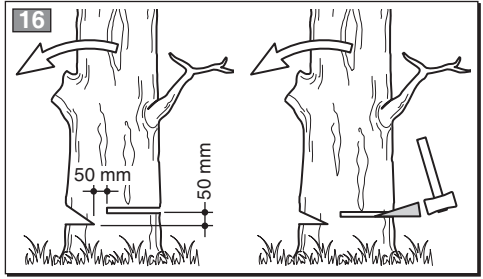
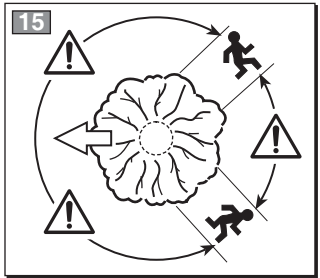
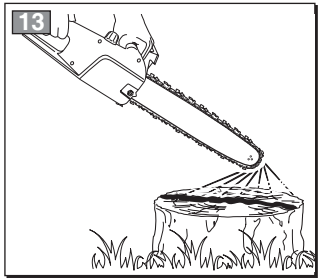
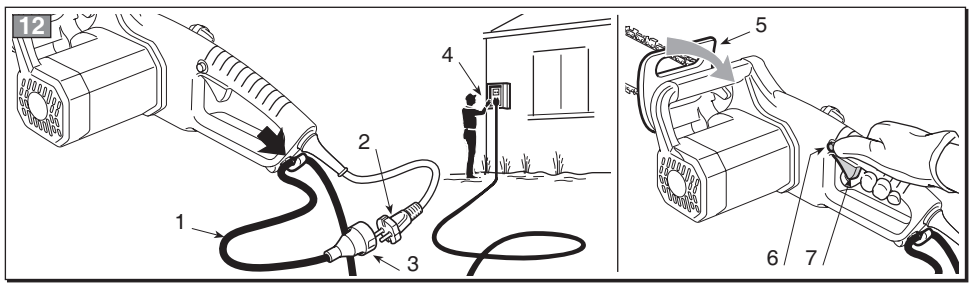

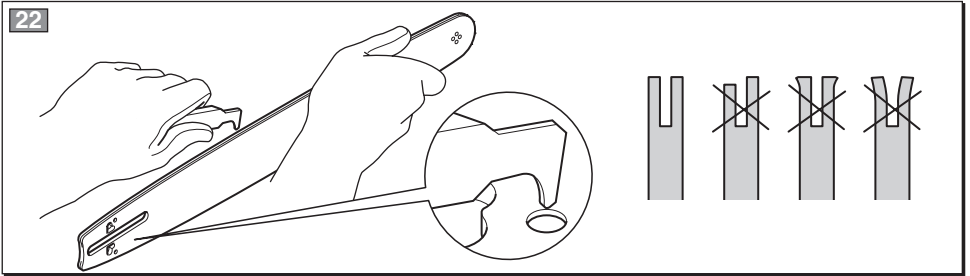
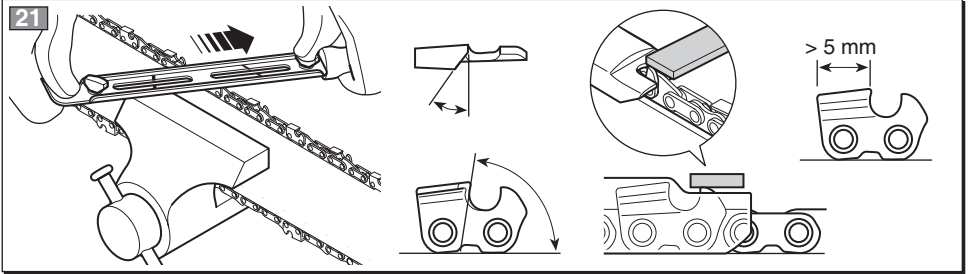
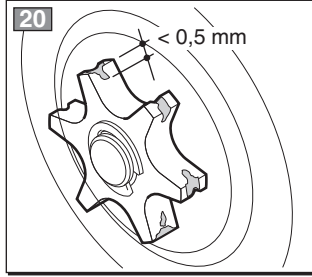

Dear Customer,

thank you for choosing one of our products. We hope that you will be completely satisfied with this machine and that it fully meets your expectations. This manual has been compiled in order to provide you with all the information you need to get acquainted with the machine and use it safely and efficiently. Don't forget that it is an integral part of the machine, so keep it handy so that it can be consulted when necessary, and pass it on to a further user if you resell or loan the machine.

Your new machine has been designed and manufactured in pursuance with current regulations, and is safe and reliable if used in compliance with the instructions provided in this manual (proper use). Using the machine in any other way, or non-compliance with the safety specifications relative to use, maintenance and repair is considered "improper use" which will invalidate the warranty, relieve the manufacturer from all liabilities, and the user will consequently be liable for all and any damage or injury to himself or others.

Since we regular improve our products, you may find slight differences between your machine and the descriptions contained in this manual. Modifications can be made to the machine without notice and without the obligation to update the manual, although the essential safety and function characteristics will remain unaltered. In case of any doubts, please contact your dealer. And now enjoy your work!

TABLE OF CONTENTS

1. Identification of the main components	2
2. Symbols	3
3. Safety warnings	4
4. Machine assembly	6
5. Preparing to work	7
6. How to start - Stop the engine	8
7. Using the machine	9
8. Maintenance and storage	13
9. Accessories	14

1. IDENTIFICATION OF MAIN COMPONENTS

MAIN COMPONENTS

1. Power unit
2. Spiked bumper
3. Front hand guard
4. Front handgrip
5. Rear handgrip
6. Chain catcher
7. Bar
8. Chain
9. Bar cover
10. Identification plate
11. Power cable
12. Extension lead (not supplied)

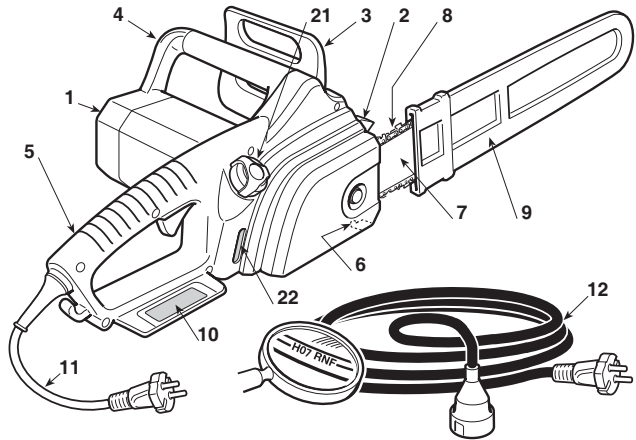

CONTROLS AND FILLING POINTS

13. Trigger switch
14. Safety button
15. Extension lead connection
21. Chain oil tank cap
22. Chain oil gauge

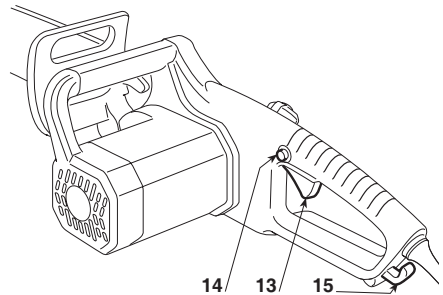

IDENTIFICATION PLATE

- 10.1) EC-Conformity marking
- 10.2) Name and address of the manufacturer
- 10.3) Acoustic output level
- 10.4) Machine type
- 10.5) Serial number
- 10.6) Year of manufacture
- 10.7) Power supply frequency and voltage
- 10.8) Engine power
- 10.9) Dual insulation
- 10.10) Article Code
- 10.11) Maximum permitted length of the bar.
Do not use longer bars.

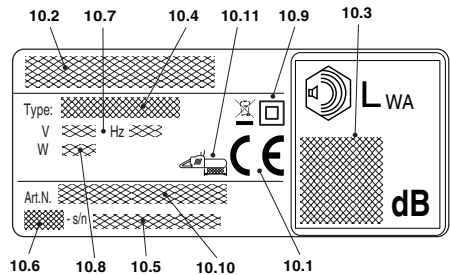

The example of the declaration of conformity can be found on the penultimate page of the manual.



Do not dispose of electrical equipment together with household waste material. In observance of European Directive 2012/19/EU on waste electrical and electronic equipment and its implementation in accordance with national law, electric equipment that have reached the end of their life must be collected separately and returned to an environmentally compatible recycling facility. If electrical appliances are disposed of in landfills or dumps, hazardous substances can leak into the ground-water and get into the foodchain, damaging your health and well-being. For further information on the disposal of this product, contact your dealer or a domestic waste collection Service.

Maximum noise and vibration levels [1]	Model	EA 1800 (14")	EA 1800 (16")	EA 2000 Q
Operator ear noise pressure level	dB(A)	84,7	85	84,53
- Measurement uncertainty	dB(A)	3	3	3
Measured acoustic output level	dB(A)	104,7	104,3	104,4
- Measurement uncertainty	dB(A)	0,32	1,99	0,64
Garanteed sound power level	dB(A)	109	109	109
Vibration level				
- Front handle	m/sec ²	4,733	4,211	4,957
- Rear handle	m/sec ²	6,127	6,134	5,418
- Measurement uncertainty	m/sec ²	1.5	1.5	1.5
TECHNICAL SPECIFICATIONS				
Voltage	V~	230		230
Power frequency	Hz	50		50
Motor power	W	1800		2000
Bar length	cm	35	40	40
Cutting length	cm	33,5	38,5	38,5
Chain speed	m/sec	13,5		13,5
Weight	kg	3.75 ± 3.9		3.75 ± 3.9
Oil tank capacity	ml	85		85
Maximum admissible rpm without load	min ⁻¹	7600		7600

[1]

Notice:

The vibration value indicated was determined with a standardized tool and can be used to make comparisons with other electric equipment as well as temporary estimates of the load through the vibrations.

WARNING!

The vibration value may vary according to the usage of the machine and its fitted equipment, and be higher than the one indicated. Safety measures must be established to protect the user and must be based on the load estimate generated by the vibrations in real usage conditions. In this regard, all the operational cycle phases must be taken into consideration, such as switching off or idle running.

2. SYMBOLS

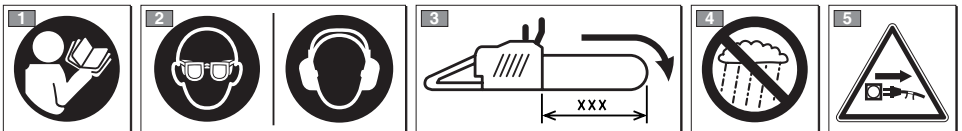

- 1) Read the instruction manual before using the machine.
- 2) If you are using the machine every day in normal conditions, you can be exposed to a noise level of 85 dB (A) or higher. Wear safety glasses and hearing protection. Wear safety glasses and hearing protection.
- 3) Maximum permitted length of the bar. Do not use longer bars.
- 4) Do not leave the machine in the rain (or in damp conditions).
- 5) Unplug the chain-saw immediately if the cable (or extension lead) is cut or damaged.

EXPLANATORY SYMBOLS ON THE MACHINE (if present)

11



11) Direction in which the chain is mounted

3. SAFETY WARNINGS

HOW TO READ THE MANUAL

Certain paragraphs in the manual contain particularly significant information and are marked with various levels of highlighting with the following meaning:

NOTE

or

IMPORTANT

These give details or further information on what has already been said, in the aim to prevent damage to the machine.

⚠ WARNING! *Non-observance will result in the risk of injury to oneself or others.*

⚠ DANGER! *Non-observance will result in the risk of serious injury or death to oneself or others.*

GENERAL POWER TOOL SAFETY WARNINGS

⚠ WARNING! *Read all safety warnings and all instructions. Failure to follow the warnings and instructions may result in electric shock, fire and/or serious injury.*

Save all warnings and instructions for future reference. The term "power tool" in the warnings refers to your mains-operated (corded) power tool.

1) Work area safety

- a) **Keep work area clean and well lit.** Cluttered or dark areas invite accidents.
- b) **Do not operate power tools in explosive atmospheres, such as in the presence of flammable liquids, gases or dust.** Power tools create sparks which may ignite the dust or fumes.
- c) **Keep children and bystanders away while operating a power tool.** Distractions can cause you to lose control.

2) Electrical safety

- a) **Power tool plugs must match the outlet. Never modify the plug in any way. Do not use any adapter plugs with earthed (grounded) power tools.** Unmodified plugs and matching outlets will reduce risk of electric shock.
- b) **Avoid body contact with earthed or grounded surfaces, such as pipes, radiators, ranges and refrigerators.** There is an increased risk of electric shock if your body is earthed or grounded.
- c) **Do not expose power tools to rain or wet conditions.** Water entering a power tool will increase the risk of electric shock.
- d) **Do not abuse the cord. Never use the cord for carrying, pulling or unplugging the power tool. Keep cord away from heat, oil, sharp edges or moving parts.** Damaged or entangled cords increase the risk of electric shock.

- e) **When operating a power tool outdoors, use an extension cord suitable for outdoor use.** Use of a cord suitable for outdoor use reduces the risk of electric shock.
- f) **If operating a power tool in a damp location is unavoidable, use a residual current device (RCD) protected supply.** Use of an RCD reduces the risk of electric shock.

3) Personal safety

- a) **Stay alert, watch what you are doing and use common sense when operating a power tool. Do not use a power tool while you are tired or under the influence of drugs, alcohol or medication.** A moment of inattention while operating power tools may result in serious personal injury.
- b) **Use personal protective equipment. Always wear eye protection.** Protective equipment such as dust mask, non-skid safety shoes, hard hat, or hearing protection used for appropriate conditions will reduce personal injuries.
- c) **Prevent unintentional starting. Ensure the switch is in the off-position before connecting to power source, picking up or carrying the tool.** Carrying power tools with your finger on the switch or energising power tools that have the switch on invites accidents.
- d) **Remove any adjusting key or wrench before turning the power tool on.** A wrench or a key left attached to a rotating part of the power tool may result in personal injury.
- e) **Do not overreach. Keep proper footing and balance at all times.** This enables better control of the power tool in unexpected situations.
- f) **Dress properly. Do not wear loose clothing or jewellery. Keep your hair, clothing and gloves away from moving parts.** Loose clothes, jewellery or long hair can be caught in moving parts.
- g) **If devices are provided for the connection of dust extraction and collection facilities, ensure these are connected and properly used.** Use of dust collection can reduce dust-related hazards.

4) Power tool use and care

- a) **Do not force the power tool. Use the correct power tool for your application.** The correct power tool will do the job better and safer at the rate for which it was designed.
- b) **Do not use the power tool if the switch does not turn it on and off.** Any power tool that cannot be controlled with the switch is dangerous and must be repaired.
- c) **Disconnect the plug from the power source before making any adjustments, changing accessories, or storing power tools.** Such preventive safety measures reduce the risk of starting the power tool accidentally.
- d) **Store idle power tools out of the reach of children and do not allow persons unfamiliar with the power tool or these instructions to operate the power tool.** Power tools are dangerous in the hands of untrained users.
- e) **Maintain power tools. Check for misalignment or binding of moving parts, breakage of parts and any other condition that may affect the power tool's operation. If damaged, have the power tool repaired before use.** Many accidents are caused by poorly maintained power tools.
- f) **Keep cutting tools sharp and clean.** Properly maintained cutting tools with sharp cutting edges are less likely to bind and are easier to control.
- g) **Use the power tool, accessories and tool bits etc. in**

accordance with these instructions, taking into account the working conditions and the work to be performed.

Use of the power tool for operations different from those intended could result in a hazardous situation.

5) Service

- a) **Have your power tool serviced by a qualified repair person using only identical replacement parts.** This will ensure that the safety of the power tool is maintained.

CHAIN SAW SAFETY WARNINGS:

- **Keep all parts of the body away from the saw chain when the chain saw is operating. Before you start the chain saw, make sure the saw chain is not contacting anything.** A moment of inattention while operating chain saws may cause entanglement of your clothing or body with the saw chain.
- **Always hold the chain saw with your right hand on the rear handle and your left hand on the front handle.** Holding the chain saw with a reversed hand configuration increases the risk of personal injury and should never be done.
- **Wear safety glasses and hearing protection. Further protective equipment for head, hands, legs and feet is recommended.** Adequate protective clothing will reduce personal injury by flying debris or accidental contact with the saw chain.
- **Do not operate a chain saw in a tree.** Operation of a chain saw while up in a tree may result in personal injury.
- **Always keep proper footing and operate the chain saw only when standing on fixed, secure and level surface.** Slippery or unstable surfaces such as ladders may cause a loss of balance or control of the chain saw.
- **When cutting a limb that is under tension be alert for spring back.** When the tension in the wood fibres is released the spring loaded limb may strike the operator and/or throw the chain saw out of control.
- **Use extreme caution when cutting brush and saplings.** The slender material may catch the saw chain and be whipped toward you or pull you off balance.
- **Carry the chain saw by the front handle with the chain saw switched off and away from your body. When transporting or storing the chain saw always fit the guide bar cover.** Proper handling of the chain saw will reduce the likelihood of accidental contact with the moving saw chain.
- **Follow instructions for lubricating, chain tensioning and changing accessories.** Improperly tensioned or lubricated chain may either break or increase the chance for kickback.
- **Keep handles dry, clean, and free from oil and grease.** Greasy, oily handles are slippery causing loss of control.
- **Cut wood only. Do not use chain saw for purposes not intended. For example: do not use chain saw for cutting plastic, masonry or non-wood building materials.** Use of the chain saw for operations different than intended could result in a hazardous situation.

CAUSES AND OPERATOR PREVENTION OF KICKBACK:

Kickback may occur when the nose or tip of the guide bar touches an object, or when the wood closes in and pinches the saw chain in the cut.

Tip contact in some cases may cause a sudden reverse reaction, kicking the guide bar up and back towards the operator.

Pinching the saw chain along the top of the guide bar may push the guide bar rapidly back towards the operator.

Either of these reactions may cause you to lose control of the saw which could result in serious personal injury. Do not rely exclusively upon the safety devices built into your saw.

As a chain saw user, you should take several steps to keep your cutting jobs free from accident or injury.

Kickback is the result of tool misuse and/or incorrect operating procedures or conditions and can be avoided by taking proper precautions as given below:

- **Maintain a firm grip, with thumbs and fingers encircling the chain saw handles, with both hands on the saw and position your body and arm to allow you to resist kickback forces.** Kickback forces can be controlled by the operator, if proper precautions are taken. Do not let go of the chain saw.
- **Do not overreach and do not cut above shoulder height.** This helps prevent unintended tip contact and enables better control of the chain saw in unexpected situations.
- **Only use replacement bars and chains specified by the manufacturer.** Incorrect replacement bars and chains may cause chain breakage and/or kickback.
- **Follow the manufacturer's sharpening and maintenance instructions for the saw chain.** Decreasing the depth gauge height can lead to increased kickback.
- **Techniques for using the electric chain-saw**

Always observe the safety regulations and use the most suitable sawing techniques (see chapter 7 for instructions and examples).

• Safe carrying of the saw

Whenever the machine is to be handled or transported you must:

- turn off the engine, wait for the chain to stop and unplug the machine from the mains;
- mount the bar cover;
- only hold the machine using the handgrips and position the bar in the opposite direction to that used during operation.

When using a vehicle to transport the machine, position it so that it can cause no danger to persons and fasten it firmly.

• Recommendation for the first-time users

Before felling or delimiting for the first time, make sure:

- you have been specifically trained to use this type of equipment;
- you have carefully read the safety regulations and user instructions contained in this manual;
- you practise first on logs on the ground or attached to trestles, in order to get familiar with the machine and the most suitable cutting techniques.

4. MACHINE ASSEMBLY

PACKAGING CONTENTS

The packaging contains:

- power unit,
- bar,
- chain,
- bar cover,
- bag containing equipment and documents.

IMPORTANT

The machine is supplied with the bar and chain dismantled and the oil tank empty.

⚠ WARNING! *Unpacking and completing the assembly should be done on a flat and stable surface, with enough space for machine handling and its packaging, always making use of suitable equipment. Disposal of the packaging should be done in accordance with the local regulations in force.*

BAR AND CHAIN MOUNTING

⚠ WARNING! *Always wear heavy-duty gloves when handling the bar and chain. Mount the bar and chain very carefully so as not to impair the safety and efficiency of the machine. If in doubt, contact your dealer.*

Before fitting the bar, make sure the chain brake is not engaged; this is done by pulling the front hand guard right back towards the body of the machine.

⚠ WARNING! *Make sure the machine is not plugged into the mains socket.*

• MACHINES WITH STANDARD CHAIN TENSION ADJUSTER

- Remove the rubber protection (1a), unscrew the nut (1) and remove the guard to get to the drive sprocket and the point where the bar is fitted (Fig. 1).

- Mount the chain in the right direction on the bar. If the tip of the bar has a nose sprocket, make sure the drive links are correctly inserted in the sprocket rims (Fig. 2).
- Mount the bar (2) by inserting the stud bolt in the groove and push it towards the back of the machine body and wind the chain around the drive sprocket (Fig. 3).
- Check that the chain tension adjuster pin (3) is fitted properly in the hole on the bar (Fig. 4); if it isn't, turn the chain tension adjuster screw (4) using a screwdriver until the pin is completely inserted (Fig. 5).
- Fit the guard back on without tightening the nut (1).
- Turn the chain tension adjuster screw (4) to adjust the chain tension (Fig. 5).
- Raise the bar and tighten the guard nut (1) securely using the supplied wrench, then replace the rubber protection (1a) (Fig. 6).

• MACHINES WITH “Q-TENS” QUICK CHAIN TENSION ADJUSTER

- Unscrew the handle (11) and remove the guard to get to the drive sprocket and the point where the bar is fitted (Fig. 1a).
- Mount the chain in the right direction on the bar. If the tip of the bar has a nose sprocket, make sure the drive links are correctly inserted in the sprocket rims (Fig. 2).
- Mount the bar (2) by inserting the stud bolt in the groove and push it towards the back of the machine body and wind the chain around the drive sprocket (Fig. 3).
- Fit the guard back on without tightening the handle (11).
- Check that the chain tension adjuster pin (3) is fitted properly in the hole on the bar (Fig. 4); if it isn't, turn the chain tension adjuster ring-nut (12) until the pin is completely inserted (Fig. 5a).
- Turn the ring-nut (12) to obtain the desired chain tension level (Fig. 5a).
- Raise the bar and tighten the handle (11) securely (Fig. 6a).

5. PREPARING TO WORK

1. CHECKING THE MACHINE

⚠ WARNING! *Make sure the machine is not plugged into the mains socket.*

Before starting work please:

- check that the mains frequency and voltage is the same as the rating data on the “identification plate” (see chap. 1 - 10.8);
- check that all the screws on the machine and the bar are tightly fastened;
- check that the chain is tensioned correctly, sharp and there are no signs of any damage;
- check that handgrips and protection devices are clean and dry, correctly mounted and well fastened to the machine;
- check that the chain brake is working efficiently;
- check that the trigger switch and the safety button should move freely without forcing and return automatically and rapidly back to their neutral position;
- check that the trigger switch must remain locked until the safety button is pressed;
- make sure the cooling air vents are not clogged up with sawdust or debris;
- check that the power cable and extension lead are not damaged;
- check that the chain’s oil level is not below the «MIN» level mark and top up to 1 cm from the rim of the filler if necessary.

2. CHECKING THE CHAIN TENSION

⚠ WARNING! *Make sure the machine is not plugged into the mains socket.*

• MACHINES WITH STANDARD CHAIN TENSION ADJUSTER

- Loosen the guard nut, using the wrench (Fig. 5).
- Turn the chain tension adjuster screw (4) to adjust the chain tension (Fig. 5).
- Raise the bar and tighten the guard nut securely using the wrench (Fig. 6).

The tension is correct when the drive links do not slip out of the chain guides if you hold the chain in the middle of the bar (Fig. 7).

Loosen the brake by pressing both the switch and the safety button. Using a screwdriver, run the chain along the guides to check that it moves smoothly.

• MACHINES WITH “Q-TENS” QUICK CHAIN TENSION ADJUSTER

- Loosen the handle (11). (Fig. 5a).
- Turn the ring-nut (12) to obtain the desired chain tension level (Fig. 5a).
- Raise the bar and tighten the handle (11) securely (Fig. 6a).

The tension is correct when the drive links do not slip out of the chain guides if you hold the chain in the middle of the bar (Fig. 7).

Loosen the brake by pressing both the switch and the safety button. Using a screwdriver, run the chain along the guides to check that it moves smoothly.

3. CHECKING THE CHAIN BRAKE

This machine is equipped with a double braking system that intervenes in two situations:

- a) **When the switch lever is released**, a brake is automatically activated that slows and stops chain movement, in order to prevent the risk of injury should the chain continue to turn after it has been switched off.
- b) **In the event of a kickback while working**, following an irregular contact of the tip of the bar, with a brusque upward movement that causes the hand to strike the front guard. In this case, the brake blocks chain movement and must be released manually in order to disengage it.

This brake can be operated manually by pushing the front guard forward. To release the brake, pull the front guard towards the handgrip until you hear a click.

To check that the brake works efficiently, proceed as follows:

- Start the engine by holding the front handgrip and push the front hand guard forwards with your thumb (towards the bar).
- When the brake is engaged, release the trigger switch.

The chain must stop as soon as the brake is engaged.

⚠ WARNING! *Do not use the machine if the chain brake does not function correctly and have it inspected by your dealer.*

4. CHAIN LUBRICANT

IMPORTANT *Only use chain-saw oil or adhesive oil for chain-saws. Do not use oil containing impurities, to avoid clogging the tank filter and permanently damaging the oiler.*

IMPORTANT *The chain lubricating oil is bio-degradable. The use of mineral oil or engine oil can have a serious impact on the environment.*

It is essential that you use good quality oil to lubricate the cutting parts effectively. Used or poor quality oil does not guarantee good lubrication and reduces the duration of the chain and bar.

IMPORTANT *Before each machine use, the oil level should be checked and topped up to 1 cm from the rim of the filler. The oil level must not drop below the «MIN» level mark.*

5. ELECTRICAL CONNECTIONS

⚠ DANGER! *Electricity and moisture are not compatible.*
 – *Always handle and connect electric cables in dry conditions.*

– *Keep electric sockets or cables away from wet and damp areas (e.g. puddles or wet ground).*

The quality of the extension leads must be no less than **H07RN-F** or **H07VV-F**, with a minimum section of 2.5 mm² and a recommended maximum length of 30 m.

To avoid overheating, do not keep the extension lead rolled up during use.

⚠ DANGER! *The permanent connection of any electrical equipment to the mains of a building must be installed by a qualified electrician in conformity with the regulations in force. Incorrect wiring can cause serious injury and even death.*

⚠ DANGER! *Supply power to the machine using a differential switch (RCD - Residual Current Device) with a tripping current of max. 30 mA.*

IMPORTANT *To prevent power supply outages:*

- *make sure that the electric system's overall capacity is adequate;*
- *connect the machine to a mains socket with sufficient amperage;*
- *avoid simultaneous use of other electrical appliances with high power consumption.*

6. HOW TO START - STOP THE ENGINE

STARTING THE ENGINE (Fig. 12)

Before starting the engine:

- Fasten the extension lead (1) to the cable clamp on the rear handgrip.
- **FIRST** connect the power cable plug (2) to the extension lead (3) and **THEN** plug the extension lead into the mains socket (4).
- Take off the bar cover.
- Make sure the bar is not touching the ground or any other object

To start the engine (Fig. 12):

1. Disengage the chain brake (5) by pulling the front hand guard towards the front handgrip.
2. Hold the chain-saw firmly with both hands.
3. Press the safety button (6) and then the switch (7).

NOTE *When you release the switch, the safety button is also released and the engine stops.*

⚠ WARNING! *The chain may take one second to come to a stop after the engine is switched off.*

STOPPING THE ENGINE

To stop the engine:

- Release the switch (7).
- **FIRST** unplug the extension lead (3) from the mains socket (4) and **THEN** disconnect the power cable (2) of the machine from the extension lead (3).

7. USING THE MACHINE

⚠ WARNING! For personal safety and that of others:

- 1) Do not use the machine without reading the instructions carefully. Become acquainted with the controls and the proper use of the machine. Learn how to stop the engine quickly.
- 2) Only use the machine for the purpose for which it was designed, that is for "felling, bucking and delimiting trees with dimensions suitable for the length of the bar" or wooden objects with the same characteristics. Any other use, such as using accessories not specified in this manual, may be hazardous and also damage the machine. Examples of improper use may include, but are not limited to:
 - trimming hedges;
 - intaglio carving;
 - sectioning pallets, crates and various packing materials;
 - sectioning furniture or other materials with nails, screws or other metal components;
 - butchering meat;
 - using the machine to lift, move or split objects;
 - using the machine while fastened to fixed supports.
- 3) Keep in mind that the operator or user is responsible for accidents or hazards occurring to other people or their property.
- 4) Always wear suitable clothing when using the machine. Your dealer can provide you with all the information on the most suitable accident-prevention devices to guarantee your safety. Wear anti-vibration gloves. All the above-mentioned precautions do not however guarantee the prevention of certain risks – i.e. Raynaud's phenomenon or Carpal tunnel syndrome. For operators who use this machine for prolonged periods, it is therefore recommended to have periodic check-ups on the hands and fingers.
If any of the above mentioned symptoms should appear, please contact a physician immediately.
- 5) Mow only in daylight or good artificial light.
- 6) Take utmost care when working near metal fences
- 7) Keep the chain away from the electric cable. Use the cable clamp to prevent the extension lead from disconnecting accidentally. Make sure it is connected to the socket without being forced. Never touch a live electric cable if it is poorly insulated.

If the extension lead gets damaged during use, do not touch the cable and unplug the extension lead immediately.

- 8) Take care not to hit the bar hard against foreign objects or flying debris caused by the movement of the chain.
- 9) Stop the engine and unplug the machine from the mains:
 - whenever you leave the machine unattended;
 - before cleaning, checking or servicing the machine;
 - after striking a foreign object. Inspect the machine for any damage and make repairs before restarting it again;
 - if the machine begins to abnormally vibrate (Immediate look for the cause of the vibrations and take for necessary controls at a Specialised Centre).
 - when the machine is not in use.

IMPORTANT Always remember that an incorrectly used electric chain-saw may disturb others and have a serious impact on the environment.

To respect people and the environment:

- Avoid using the machine in environments or at times of the day when it may disturb others.
- Scrupulously comply with local regulations and provisions for the disposal of waste materials after sawing.
- Scrupulously comply with local regulations and provisions for the disposal of oils, damaged parts or any elements which have a strong impact on the environment.
- A certain amount of chain lubricating oil is released into the environment when the machine is running, so only use biodegradable oils made specifically for this use.
- To avoid the risk of fire, do not leave the machine with the engine hot on leaves or dry grass.

⚠ WARNING! It takes specific training to use the machine for felling and delimiting.

1. CHECKS DURING WORK

• Checking the chain tension

The chain tends to stretch gradually as you work, so you need to check its tension frequently.

IMPORTANT *During the first period of use (or after replacing the chain), it must be checked more frequently due to settling of the chain.*

⚠ WARNING! *Never work with the chain loose, as it can be hazardous if the chain slips out of its guides.*

To adjust the chain tension, follow the instructions in Chapter 5.2.

• Checking the oil delivery

IMPORTANT *Never use the machine without lubrication! You can check the oil level in the tank through the transparent gauge. Make sure you fill up the oil tank every time you use the machine.*

⚠ WARNING! *Make sure the bar and the chain are in place when you check the oil delivery.*

Start the engine and check if the chain oil is delivered as shown in the figure (Fig. 13).

2. DIRECTIONS FOR USE AND CUTTING TECHNIQUES

Before felling or delimiting for the first time, practise sawing logs on the ground or on trestles, so that you can get familiar with the machine and the most suitable sawing techniques.

⚠ WARNING! *Always hold the machine with both hands when sawing.*

⚠ WARNING! *Stop the engine immediately if the chain stops during sawing. Beware of kickback, which can occur if the bar contacts an obstacle.*

• Felling a tree

- When bucking and felling operations are being performed by two or more persons at the same time, the felling operations should be separated from the bucking operation by a distance of at least twice the height of the tree being felled. Trees should not be felled in a manner that would endanger any person, strike any utility line or cause any property damage. If the tree does make contact with any utility line, the company should be notified immediately.
- The chain saw operator should keep on the uphill side of the terrain as the tree is likely to roll or slide downhill after it is felled.
- An escape path should be planned and cleared as necessary before cuts are started. The escape path should extend back and diagonally to the rear of the expected line of fall as illustrated in Figure 15.
- Before felling is started, consider the natural lean of the tree, the location of larger branches and the wind direction to judge which way the tree will fall.
- Remove dirt, stones, loose bark, nails, staples and wire from the tree.

• Notching undercut

Make the notch 1/3 the diameter of the tree, perpendicular to the direction of falls as illustrated in Figure 16.

Make the lower horizontal notching cut first.

his will help to avoid pinching either the saw chain or the guide bar when the second notch is being made.

• Felling back cut

- Make the felling back cut at least 50 mm higher than the horizontal notching cut as illustrated in Figure 16. Keep the felling back cut parallel to the horizontal notching cut. Make the felling back cut so enough wood is left to act as a hinge. The hinge wood keeps the tree from twisting and falling in the wrong direction. Do not cut through the hinge.
- As the felling gets close to the hinge, the tree should begin to fall. If there is any chance that the tree may not fall in desired direction or it may rock back and bind the saw chain, stop cutting before the felling back cut is complete and use wedges of wood, plastic or aluminium to open the cut and drop the tree along the desired line of fall.

– When the tree begins to fall remove the chain saw from the cut, stop the motor, put the chain saw down, then use the retreat path planned. Be alert for overhead limbs falling and watch your footing.

• Limbing a tree

Limbing is removing the branches from a fallen tree. When limbing leave larger lower limbs to support the log off the ground. Remove the small limbs in one cut as illustrated in Figure 17. Branches under tension should be cut from the bottom up to avoid binding the chain saw.

⚠ WARNING! *Be careful of where the branches are lying on the ground, the risk of them being under tension, the direction the branch may go during cutting and the risk of the tree being unstable after the branch has been cut.*

• Bucking a log

Bucking is cutting a log into lengths. It is important to make sure your footing is firm and your weight is evenly distributed on both feet. When possible, the log should be raised and supported by the use of limbs, logs or chocks. Follow the simple directions for easy cutting.

- When the log is supported along its entire length as illustrated in Figure 18A, it is cut from the top (overbuck).
- When the log is supported on one end, as illustrated in Figure 18B, cut 1/3 the diameter from the underside (underbuck). Then make the finished cut by overbucking to meet the first cut.
- When the log is supported on both ends, as illustrated in Figure 18C, cut 1/3 the diameter from the top (overbuck). Then make the finished cut by underbucking the lower 2/3 to meet the first cut.
- It is easier to saw a log using the spiked bumper (Figure 18D).
 - Dig the spiked bumper into the log and use it as a pivot. Cut with an arched motion to make the bar penetrate the wood.
 - Repeat several times if necessary, changing the point where you plant the spiked bumper.

– When bucking on a slope always stand on the uphill side of the log, as illustrated in Figure 19. When “cutting through”, to maintain complete control release the cutting pressure near the end of the cut without relaxing your grip on the chain saw handles. Don’t let the chain contact the ground.

After completing the cut, wait for the saw chain to stop before you move the chain saw. Always stop the motor before moving from tree to tree.

3. END OF OPERATIONS

When you have finished your work:

- Switch off the engine as indicated above (Chap. 6).
- Wait for the chain to stop and allow the machine to cool.
- Remove any traces of sawdust or oil deposits from the chain.
- If there is excessive dirt or resin build-up, disassemble the chain and place it in a container with a specific cleanser. Then rinse it with clean water and treat it with a suitable anticorrosive spray, before reassembling on the machine.
- Fit the bar cover before reassembling the machine.

⚠ WARNING! *Allow the engine to cool before storing in any enclosure. To reduce fire hazards, clean the machine thoroughly to get rid of any sawdust, branches, leaves or excess grease, never leave containers with the cut debris inside the storage area.*

8. MAINTENANCE AND STORAGE

⚠ WARNING! *For your safety and that of others:*

- *Correct maintenance is essential to maintain the original efficiency and safety of the machine over time.*
- *Keep all nuts, bolts and screws tight to be sure the equipment is in safe working condition.*
- *Never use the machine with worn or damaged parts. Damaged parts are to be replaced and never repaired.*
- *Only use original spare parts. Parts that are not of the same quality can seriously damage the equipment and compromise safety.*

⚠ WARNING! *During maintenance operations:*

- *Unplug the machine from the mains.*
- *Use protective gloves when handling the bar and chain.*
- *Keep the bar protection devices on, except when intervening directly on the bar or the chain.*
- *Never dispose of oils or other polluting materials in unauthorised places.*

1. ENGINE COOLING

To avoid overheating and damage to the engine, always keep the cooling air vents clean and free of sawdust and debris.

2. CHAIN BRAKE

Regularly check the efficiency of the chain brake.

3. CHAIN SPROCKET (Fig. 20)

Regularly check the condition of the sprocket and replace it when wear exceeds 0.5 mm.

Do not mount a new chain with a worn sprocket or vice-versa.

4. CHAIN CATCHER

This is an important safety device that restrains the chain if it breaks or degrooves.

Regularly check the condition of the chain catcher and replace it if it gets damaged.

5. NUTS AND SCREWS

Periodically check that all the nuts and screws are securely tightened and the handgrips are tightly fastened.

6. SHARPENING THE CHAIN

⚠ WARNING! *To ensure that the chainsaw works safely and efficiently, it is essential that the cutting components are well-sharpened. Any work on the chain and bar require specific experience and special tools. For safety purposes, we recommend you contact your dealer to ensure work is done correctly.*

Sharpening is necessary when:

- The sawdust looks like dust.
- Cutting becomes more difficult.
- The cut is not straight.
- Vibrations increase.

A specialized centre will sharpen the chain using the right tools to ensure minimum removal of material and even sharpness on all the cutting edges.

If you sharpen the chain yourself, use special round-section files with the right diameter depending on the type of chain (see “Chain Maintenance Table”). You need a certain amount of skill and experience to avoid damaging the cutting edges.

Sharpen the chain as follows (Fig. 21):

- Disconnect the machine from the mains, release the chain brake and secure the bar with the chain in a vice so that the chain can run smoothly.
- Tighten the chain if it is loose.
- Mount the file in the guide and then insert it in the tooth at a constant angle from the cutting edge.
- Sharpen in a forward motion a few times and repeat this on all the cutting edges facing the

- same way (right or left).
- Turn the bar over in the vice and repeat on all the other cutting edges.
- Check that the limiter tooth does not stick out further than the inspection instrument and file any projecting parts with a flat file, rounding off the edge.
- After sharpening, remove all traces of filing and dust and lubricate the chain in an oil bath.

Replace the chain whenever:

- The length of the cutting edges reduces to 5 mm or less;
- There is too much play between the links and the rivets.

7. BAR MAINTENANCE (Fig. 22)

To avoid asymmetrical wear on the bar, make sure it is turned over periodically.

To keep the bar in perfect working order, proceed as follows:

- Grease the bearings on the nose sprocket (if present) with the syringe.
- Clean the bar groove with the scraper.
- Clean the lubrication holes.
- With a flat file, remove burr from the edges and level off the guides.

Replace the bar whenever:

- the groove is not as deep as the height of the drive links (which must never touch the bottom);
- the inside of the guide is worn enough to make the chain lean to one side.

Chain maintenance table

⚠ WARNING! *The table gives the sharpening data for different types of chains, but this does not mean you can use chains other than those approved and listed in the “Correct bar and chain combination table”.*

Chain pitch		Limiter tooth level (a)		File diameter (d)	
inches	mm	inches	mm	inches	mm
3/8 Mini	9.32	0.018	0.45	5/32	4.0
0.325	8.25	0.026	0.65	3/16	4.8
3/8	9.32	0.026	0.65	13/64	5.2
0.404	10.26	0.031	0.80	7/32	5.6

8. EMPTYING AND FLUSHING THE OIL TANK (Only if organic oil is used for the chain)

The use of some types of organic oil may cause deposits or fouling after a certain period of use.

If this happens, before leaving the machine unused for a long period of time:

- disassemble the chain and the bar;
- empty the oil tank;
- pour a specific liquid cleanser in the tank, to about half the maximum level;

- close the tank cap and operate the machine until all the cleanser runs out.

Remember to fill with oil, before using the machine again.

9. ELECTRIC CABLES

⚠ WARNING! *Check the condition of the electric cables regularly and replace them if they are worn or their insulation looks damaged.*

If the machine's power cable is damaged, it can only be replaced with an original spare part by your dealer or an authorised service centre.

All and any operations performed in unauthorised centres or by unqualified persons will totally invalidate the warranty.

10. EXTRAORDINARY MAINTENANCE

All maintenance operations not foreseen in this manual must be performed exclusively by your dealer.

11. STORAGE

The machine must be stored in a dry place away from the elements and with the bar cover correctly fitted.

9. ACCESSORIES

The table contains a list of all possible combinations between bar and chain, indicating those which may be used on each machine, marked with the symbol “*”

chain are actions made solely by the user, the latter assumes responsibility for damages of any kind due to such actions. When in doubt or if lacking knowledge of the specificity of each bar or chain, contact your retailer or specialised gardening centre.

⚠ WARNING! *In consideration that the selection, application and usage of bar and*

Bar and chain combinations

Pitch	BAR			CHAIN	Model		
	Length Inches / cm	Groove width Inches / mm	Code		Code	EA 1800 (14")	EA 1800 (16")
3/8"	14" / 35 cm	0,050" / 1,3 mm	118800388/0	4113703	*	*	
3/8"	16" / 40 cm	0,050" / 1,3 mm	118800389/0	4113706		*	*

DICHIARAZIONE CE DI CONFORMITÀ (Istruzioni Originali)

(Direttiva Macchine 2006/42/CE, Allegato II, parte A)

1. **La Società:** STIGA SpA – Via del Lavoro, 6 – 31033 Castelfranco Veneto (TV) – Italy
2. Dichiaro sotto la propria responsabilità, che la macchina: Motosega a catena elettrica portatile, abbattimento / sezionamento / sramatura di alberi

a) Tipo / Modello Base

EA 1800, EA 2000 Q

b) Mese/ Anno di costruzione

c) Matricola

d) Motore

elettrico

3. È conforme alle specifiche delle direttive:

- MD: 2006/42/EC
- e) Ente Certificatore

N°0197– TÜV Rheinland LGA Products GmbH
Tillystraße 2 – 90431 Nürnberg – Germany

f) Esame CE del tipo:

No. BM 50283844 0001

- OND: 2000/14/EC, ANNEX V
D. Lgs. 262/2002, ANNEX V (Italy)
- EMCD: 2014/30/EU
- RoHS II : 2011/65/EU

4. Riferimento alle Norme armonizzate:

EN ISO 60745-1:2009/A11:2010
EN ISO 60745-2-13:2009/A1:2010
EN 50581:2012

EN55014-1:2006/A1/A2
EN 55014-2:1997/A1/A2
EN 61000-3-2:2014
EN 61000-3-11:2000

	EA 1800 (14")	EA 1800 (16")	EA 2000 Q	
g) Livello di potenza sonora misurato	104,7	104,3	104,4	dB(A)
h) Livello di potenza sonora garantito	109	109	109	dB(A)
k) Potenza installata	1,8	1,8	2,0	kW

m) Persona autorizzata a costituire il Fascicolo Tecnico:

STIGA SpA
Via del Lavoro, 6
31033 Castelfranco Veneto (TV) - Italia

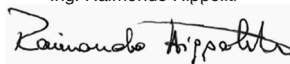

n) Castelfranco V.to, 19.06.2017

Vice Presidente Quality & Customer Service
Ing. Raimondo Hippoliti



• Soggetto a modifiche senza preavviso • Подлежи на промени без предупреждение • Moguće su promjene bez najave • Možnost změn bez předešlého upozornění • Ret til ændringer forbeholdes • Kann ohne Vorankündigung geändert werden • Υπόκειται σε αλλαγές χωρίς προειδοποίηση • Subject to modifications without notice • Sujeto a modificaciones sin previo aviso • Võimalikud muudatused ilma ette teatamata • Voidaan tehdä muutoksia ilman ennakkoilmoitusta • Sujet à des modifications sans aucun préavis • Podložno promjenama bez prethodne obavijesti • Előzetes értesítés nélkül módosítható • Objekto pakeitimai be perspėjimo • Var tikt mainīts bez iepriekšēja brīdinājuma • Подлежи на промени без претходно известување • Kan zonder kennisgeving wijzigingen ondergaan • Kan endres uten forvarsel • Poddawany modyfikacjom bez awizowania • Sujeito a alterações sem aviso prévio • Poate fi modificat, fără preaviz • Может быть изменено без преомления • Možnosť zmien bez predošlého upozornenia • Lahko pride do sprememb brez predhodnega obvestila • Podložno izmenama bez upozorenja • Kan utsättas för modifieringar utan att detta meddelas • Önceden haber verilmeksizin değiştirilebilir



.....	
Type:	 LWA dB
..... -s/n -Art.N	
	

STIGA SpA
Via del Lavoro, 6
31033 Castelfranco Veneto (TV) ITALY