

RHYTHM COACH *RMP-5*

Owner's Manual

Before using this unit, carefully read the sections entitled: "USING THE UNIT SAFELY" and "IMPORTANT NOTES" (p. 2; p. 4). These sections provide important information concerning the proper operation of the unit. Additionally, in order to feel assured that you have gained a good grasp of every feature provided by your new unit, Owner's manual should be read in its entirety. The manual should be saved and kept on hand as a convenient reference.

Main Features

- 54 high quality sounds, including 14 snare sounds.
- Mesh heads are quiet and provide natural feel and response.
- Enjoy practicing and monitor your progress.
- Thanks to battery-powered operation, you can practice anywhere.
- Easy-to-read, large LCD display.

Metronome

- The metronome's moving needle and built-in LEDs provide visual tempo indications.
- 24 rhythm types and 24 different kinds of beats, including compound times.
- 22 different patterns, including Samba Kick and Jazz Ride.

Rhythm Coach Features

- TIME CHECK: Allows visual confirmation of timing accuracy in real time.
- STROKE BALANCE: Simultaneously checks playing dynamics and timing
- ACCURACY SCORE: Confirms timing accuracy with an actual "score."
- QUIET COUNT: For developing perfect tempo
- AUTO UP/DOWN: For developing stamina and endurance
- RHYTHMIC NOTES: Progressive changes in rhythmic note values

Expandability

- Connecting optional Kick and Cymbal triggers to the EXT TRIG input enables you to practice with a basic drum kit.
- MIX IN allows practice with an external audio source — (CD, MD, MP3 etc.)

USING THE UNIT SAFELY

INSTRUCTIONS FOR THE PREVENTION OF FIRE, ELECTRIC SHOCK, OR INJURY TO PERSONS

About ⚠ WARNING and ⚠ CAUTION Notices

⚠ WARNING	Used for instructions intended to alert the user to the risk of death or severe injury should the unit be used improperly.
⚠ CAUTION	Used for instructions intended to alert the user to the risk of injury or material damage should the unit be used improperly. * Material damage refers to damage or other adverse effects caused with respect to the home and all its furnishings, as well to domestic animals or pets.

About the Symbols

	The ⚠ symbol alerts the user to important instructions or warnings. The specific meaning of the symbol is determined by the design contained within the triangle. In the case of the symbol at left, it is used for general cautions, warnings, or alerts to danger.
	The ⚡ symbol alerts the user to items that must never be carried out (are forbidden). The specific thing that must not be done is indicated by the design contained within the circle. In the case of the symbol at left, it means that the unit must never be disassembled.
	The ⚡ symbol alerts the user to things that must be carried out. The specific thing that must be done is indicated by the design contained within the circle. In the case of the symbol at left, it means that the power-cord plug must be unplugged from the outlet.

ALWAYS OBSERVE THE FOLLOWING





⚠ WARNING

- Before using this unit, make sure to read the instructions below, and the Owner's Manual.
- Do not open (or modify in any way) the unit or its AC adaptor.
- Do not attempt to repair the unit, or replace parts within it (except when this manual provides specific instructions directing you to do so). Refer all servicing to your retailer, the nearest Roland Service Center, or an authorized Roland distributor, as listed on the "Information" page.
- Never use or store the unit in places that are:
 - Subject to temperature extremes (e.g., direct sunlight in an enclosed vehicle, near a heating duct, on top of heat-generating equipment); or are
 - Damp (e.g., baths, washrooms, on wet floors); or are
 - Humid; or are
 - Exposed to rain; or are
 - Dusty; or are
 - Subject to high levels of vibration.
- This unit should be used only with the stand that is recommended by Roland (PDS-2).
- When using the unit with the stand recommended by Roland (PDS-2), the stand must be carefully placed so it is level and sure to remain stable. If not using a stand, you still need to make sure that any location you choose for placing the unit provides a level surface that will properly support the unit, and keep it from wobbling.
- Use only the specified AC adaptor (BOSS PSA series), and make sure the line voltage at the installation matches the input voltage specified on the AC adaptor's body. Other AC adaptors may use a different polarity, or be designed for a different voltage, so their use could result in damage, malfunction, or electric shock.









⚠ WARNING

- Do not excessively twist or bend the power cord, nor place heavy objects on it. Doing so can damage the cord, producing severed elements and short circuits. Damaged cords are fire and shock hazards!
- This unit, either alone or in combination with an amplifier and headphones or speakers, may be capable of producing sound levels that could cause permanent hearing loss. Do not operate for a long period of time at a high volume level, or at a level that is uncomfortable. If you experience any hearing loss or ringing in the ears, you should immediately stop using the unit, and consult an audiologist.
- Do not allow any objects (e.g., flammable material, coins, pins); or liquids of any kind (water, soft drinks, etc.) to penetrate the unit.
- Immediately turn the power off, remove the AC adaptor from the outlet, and request servicing by your retailer, the nearest Roland Service Center, or an authorized Roland distributor, as listed on the "Information" page when:
 - The AC adaptor or the power-supply cord has been damaged; or
 - If smoke or unusual odor occurs
 - Objects have fallen into, or liquid has been spilled onto the unit; or
 - The unit has been exposed to rain (or otherwise has become wet); or
 - The unit does not appear to operate normally or exhibits a marked change in performance.
- In households with small children, an adult should provide supervision until the child is capable of following all the rules essential for the safe operation of the unit.
- Protect the unit from strong impact. (Do not drop it!)







WARNING

- Do not force the unit's power-supply cord to share an outlet with an unreasonable number of other devices. Be especially careful when using extension cords—the total power used by all devices you have connected to the extension cord's outlet must never exceed the power rating (watts/amperes) for the extension cord. Excessive loads can cause the insulation on the cord to heat up and eventually melt through. 
- Before using the unit in a foreign country, consult with your retailer, the nearest Roland Service Center, or an authorized Roland distributor, as listed on the "Information" page. 
- Batteries must never be recharged, heated, taken apart, or thrown into fire or water. 

CAUTION

- The unit and the AC adaptor should be located so their location or position does not interfere with their proper ventilation. 
- This is for use only with Roland stand PDS-2. Use with other stands is capable of resulting in instability causing possible injury. 
- Always grasp only the output plug or the body of the AC adaptor when plugging into, or unplugging from, this unit or an outlet. 
- At regular intervals, you should unplug the AC adaptor and clean it by using a dry cloth to wipe all dust and other accumulations away from its prongs. Also, disconnect the power plug from the power outlet whenever the unit is to remain unused for an extended period of time. Any accumulation of dust between the power plug and the power outlet can result in poor insulation and lead to fire. 
- Try to prevent cords and cables from becoming entangled. Also, all cords and cables should be placed so they are out of the reach of children. 
- Never climb on top of, nor place heavy objects on the unit. 
- Never handle the AC adaptor body, or its output plugs, with wet hands when plugging into, or unplugging from, an outlet or this unit. 
- Before moving the unit, disconnect the AC adaptor and all cords coming from external devices. 
- Before cleaning the unit, turn off the power and unplug the AC adaptor from the outlet (p. 7, p. 9). 

CAUTION

- Whenever you suspect the possibility of lightning in your area, disconnect the AC adaptor from the outlet. 
- If used improperly, batteries may explode or leak and cause damage or injury. In the interest of safety, please read and observe the following precautions (p. 7). 
 - Carefully follow the installation instructions for batteries, and make sure you observe the correct polarity. 
 - Remove the battery whenever it is to remain unused for an extended period of time. 
 - If a battery has leaked, use a soft piece of cloth or paper towel to wipe all remnants of the discharge from the battery compartment. Then install new battery. To avoid inflammation of the skin, make sure that none of the battery discharge gets onto your hands or skin. Exercise the utmost caution so that none of the discharge gets near your eyes. Immediately rinse the affected area with running water if any of the discharge has entered the eyes.
 - Never keep batteries together with metallic objects such as ballpoint pens, necklaces, hairpins, etc.
- Used batteries must be disposed of in compliance with whatever regulations for their safe disposal that may be observed in the region in which you live. 
- When using brushes, be sure to use nylon brushes. Using metal brushes will not only scratch the head, but can also be hazardous, since the tip of the brush may catch in the mesh of the net. 

IMPORTANT NOTES

In addition to the items listed under “USING THE UNIT SAFELY” on pages 2–3, please read and observe the following:

Power Supply: Use of Batteries

- Do not connect this unit to same electrical outlet that is being used by an electrical appliance that is controlled by an inverter (such as a refrigerator, washing machine, microwave oven, or air conditioner), or that contains a motor. Depending on the way in which the electrical appliance is used, power supply noise may cause this unit to malfunction or may produce audible noise. If it is not practical to use a separate electrical outlet, connect a power supply noise filter between this unit and the electrical outlet.
- The AC adaptor will begin to generate heat after long hours of consecutive use. This is normal, and is not a cause for concern.
- The use of an AC adaptor is recommended as the unit’s power consumption is relatively high. Should you prefer to use batteries, please use the alkaline type.
- When installing or replacing batteries, always turn off the power on this unit and disconnect any other devices you may have connected. This way, you can prevent malfunction and/or damage to speakers or other devices.
- A battery is supplied with the unit. The life of this battery may be limited, however, since its primary purpose was to enable testing.
- Before connecting this unit to other devices, turn off the power to all units. This will help prevent malfunctions and/or damage to speakers or other devices.

Placement

- Using the unit near power amplifiers (or other equipment containing large power transformers) may induce hum. To alleviate the problem, change the orientation of this unit; or move it farther away from the source of interference.
- This device may interfere with radio and television reception. Do not use this device in the vicinity of such receivers.
- Noise may be produced if wireless communications devices, such as cell phones, are operated in the vicinity of this unit. Such noise could occur when receiving or initiating a call, or while conversing. Should you experience such problems, you should relocate such wireless devices so they are at a greater distance from this unit, or switch them off.
- Do not expose the unit to direct sunlight, place it near devices that radiate heat, leave it inside an enclosed vehicle, or otherwise subject it to temperature extremes. Excessive heat can deform or discolor the unit.
- When moved from one location to another where the temperature and/or humidity is very different, water droplets (condensation) may form inside the unit. Damage or malfunction may result if you attempt to use the unit in this condition. Therefore, before using the unit, you must allow it to stand for several hours, until the condensation has completely evaporated.

Maintenance

- For everyday cleaning wipe the unit with a soft, dry cloth or one that has been slightly dampened with water. To remove stubborn dirt, use a cloth impregnated with a mild, non-abrasive detergent. Afterwards, be sure to wipe the unit thoroughly with a soft, dry cloth.
- Never use benzine, thinners, alcohol or solvents of any kind, to avoid the possibility of discoloration and/or deformation.

Repairs and Data

- Please be aware that all data contained in the unit’s memory may be lost when the unit is sent for repairs. Important data should always be written down on paper (when possible). During repairs, due care is taken to avoid the loss of data. However, in certain cases (such as when circuitry related to memory itself is out of order), we regret that it may not be possible to restore the data, and Roland assumes no liability concerning such loss of data.

Additional Precautions

- Please be aware that the contents of memory can be irretrievably lost as a result of a malfunction, or the improper operation of the unit. To protect yourself against the risk of losing important data, we recommend you to write it down.
- Unfortunately, it may be impossible to restore the contents of data that was stored in the unit’s memory once it has been lost. Roland Corporation assumes no liability concerning such loss of data.
- Use a reasonable amount of care when using the unit’s buttons, sliders, or other controls; and when using its jacks and connectors. Rough handling can lead to malfunctions.
- Never strike or apply strong pressure to the display.
- When connecting / disconnecting all cables, grasp the connector itself—never pull on the cable. This way you will avoid causing shorts, or damage to the cable’s internal elements.
- To avoid disturbing your neighbors, try to keep the unit’s volume at reasonable levels. You may prefer to use headphones, so you do not need to be concerned about those around you (especially when it is late at night).
- This instrument is designed to minimize the extraneous sounds produced when it’s played. However, since sound vibrations can be transmitted through floors and walls to a greater degree than expected, take care not to allow these sounds to become a nuisance to neighbors, especially when performing at night and when using headphones.
- When you need to transport the unit, package it in the box (including padding) that it came in, if possible. Otherwise, you will need to use equivalent packaging materials.
- Use a cable from Roland to make the connection. If using some other make of connection cable, please note the following precautions.
 - Some connection cables contain resistors. Do not use cables that incorporate resistors for connecting to this unit. The use of such cables can cause the sound level to be extremely low, or impossible to hear. For information on cable specifications, contact the manufacturer of the cable.

Contents

USING THE UNIT SAFELY	2
IMPORTANT NOTES	4
Contents	5
Panel Descriptions.....	6
Getting Ready.....	7
Loading the Battery.....	7
Connecting the AC Adaptor.....	7
Adjusting the Head Tension.....	7
Mounting the RMP-5 on the Stand (PDS-2: Sold Separately).....	8
Turning the Power On and Off	9
About the Display	9
Practice	10
Changing the Sounds Assigned to the Pad	10
Sound List.....	10
Using the Metronome	11
Changing the Metronome Settings.....	11
Using Tap Tempo to Set the Metronome.....	12
Using the Rhythm Coach Mode	13
TIME CHECK	14
ACCURACY SCORE	14
QUIET COUNT	15
AUTO UP/DOWN	15
RHYTHMIC NOTES.....	16
STROKE BALANCE	16
Advanced Use.....	17
Setting the Timer	18
Using the RMP-5 with Additional Pads	19
Setup Examples.....	19
Connecting a Cymbal Pad	19
Connecting a Kick Trigger Pad	19
Connecting Other Pads.....	20
Connecting the Pads	20
Connecting Pads Capable of Playing Rim Shots	22
Parameter List.....	23
Appendices.....	26
Adjusting the Pad Sensitivity	26
Restoring the Factory Settings.....	26
If an Error Message Appears	26
Replacing the Head	27
Specifications.....	28
Sample Practice Patterns.....	29
INDEX.....	34

Panel Descriptions

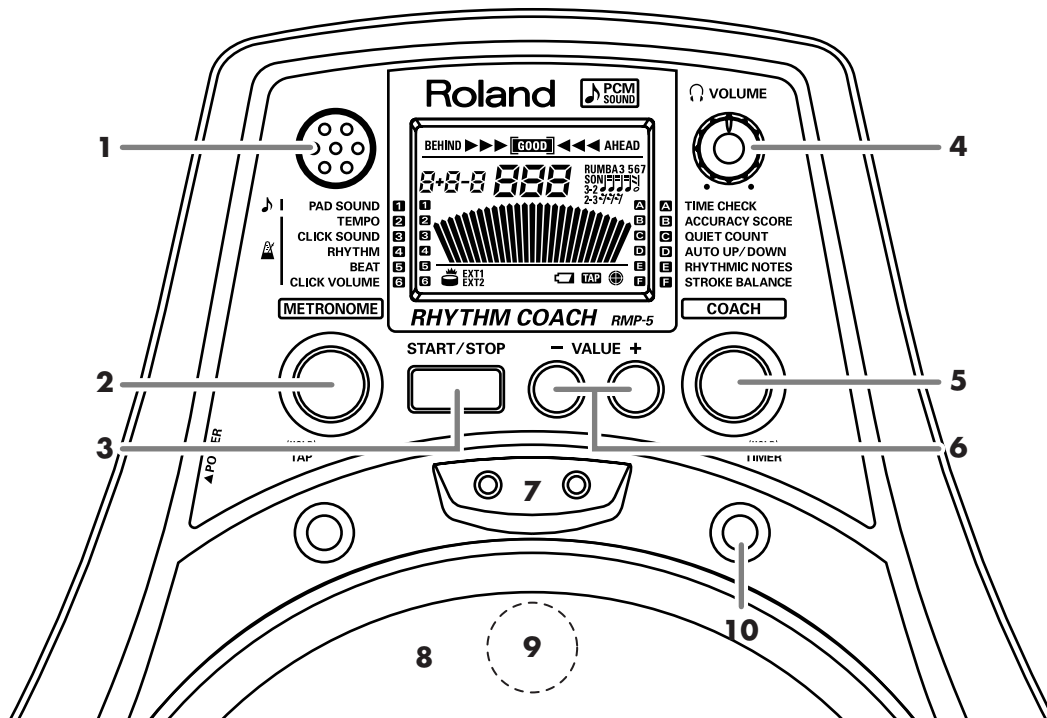

1. Mini speaker

Only the metronome sound is played from here (not the sounds from the pad).

2. [METRONOME] button

Use this to select pad sounds and for metronome settings.

When the button is held down, the tap icon () blinks in the display, you can tap the pad to set the metronome tempo (p. 12).

3. [START/STOP] button

Starts and stops the metronome.

4. VOLUME knob

Adjusts the sound level from the OUTPUT jack.

* The volume of the mini speaker is adjusted with CLICK VOLUME (p. 11).

5. [COACH] button

Selects the Rhythm Coach mode.

When this button is held down, the timer icon () lights in the display, and the RMP-5 switches to Timer mode (p. 18).

6. VALUE [+]/[-] button

Use these buttons to change the values of each parameter. To increase the value rapidly, hold down [+] and press [-]. To decrease the value rapidly, hold down [-] and press [+].

7. BEAT indicator

Flashes in quarter note timing.
Red indicator flashes on accent beats.

8. Head

9. Sensor

10. Tuning bolts

Adjusts the head tension.

Side Panel

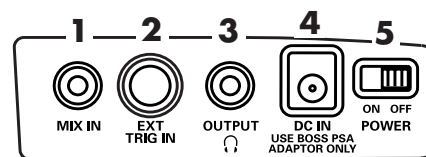

1. MIX IN jack

For connecting an external audio source (CD, MD, etc.) for playing along.

Adjust the volume using the controls on the connected device.

* Do not use a plug converter/adaptor. Due to its weight, the plug may fall out of the jack during performance.

* When connection cables with resistors are used, the volume level of equipment connected to this inputs may be low. If this happens, use connection cables that do not contain resistors, such as those from the Roland PCS series.

2. EXT TRIG IN jack

Connect other pads here.

An optional PCS-31L cable allows you to use cymbal pads and kick trigger pads. For more detailed information, refer to "Using the RMP-5 with Additional Pads" (p. 19).

3. OUTPUT jack

For headphones, amp, or audio system.

* The RMP-5 outputs sounds in monaural.

* Do not use a plug converter/adaptor. Due to its weight, the plug may fall out of the jack during performance.

4. AC Adaptor jack

Connect the AC adaptor (optional) here.

5. POWER switch

Turns the power on/off.

Getting Ready

Loading the Battery

1. Press down and slide off the lid of the battery compartment (located on the bottom of the unit).
2. Connect the snap cord to the battery, and place it inside the battery compartment.
 - * Verify the battery's polarity (+ versus -).
3. Securely close the battery cover.
 - * Do not let the snap cord get caught in the battery compartment lid.

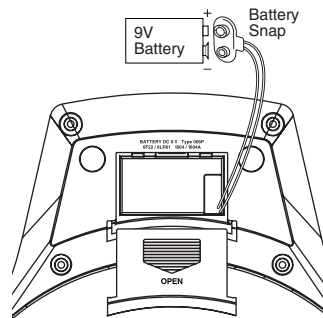

When to Change the Battery

The Battery LOW indicator () at the lower right of the display begins to flash when the battery power drops.

Insufficient battery power lowers the volume level of the mini speaker and causes unstable operation. Replace the battery as soon as possible.

- * We recommend replacement with alkaline batteries.

Connecting the AC Adaptor

A BOSS PSA series AC adaptor (sold separately) can be used to power the RMP-5.



Turn off the power before connecting the AC adaptor.



Use only the BOSS PSA-series AC adaptor. Other adaptors may cause malfunction or damage to the RMP-5 and must never be used.

Adjusting the Head Tension

BEFORE playing the RMP-5, you must tune the head to your preferred playing tension. The head is NOT tuned before shipping.

Always tighten the tuning bolts in the order shown in the figure.

- * Failure to adjust the tension may result in damage to the head.
- * Head tension may change with extended use. Make adjustments as needed.

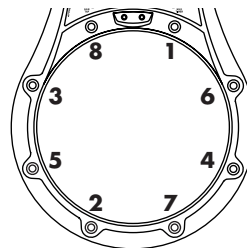

Mounting the RMP-5 on the Stand (PDS-2: Sold Separately)

1. First, open the tripod so the legs are spaced at least 50 cm (20") apart.

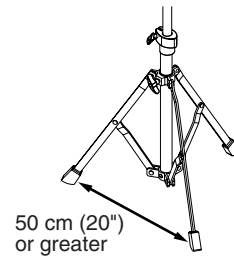

2. Attach the wing screw and washer in the order shown in the figure.

3. Attach the pad.

Turn the pad until the screw is just about all the way in; then stop, and tighten the wing screw from underneath the stand.

* Do not forcefully try to turn the pad after the screw is already all the way in. Doing so may damage the stand's screw.

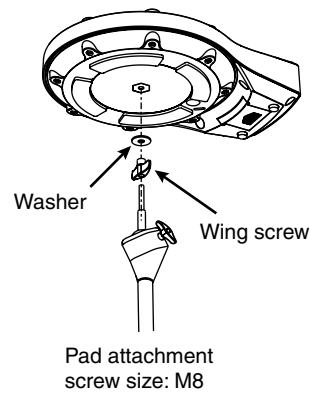

4. Adjust the angle of the pad.

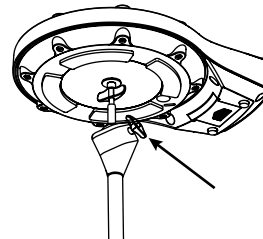

Precautions When Folding the Tripod

When folding the PDS-2's tripod legs to store the unit, be cautious not to get your fingers pinched while handling the stand.

Turning the Power On and Off

* Once the connections have been completed, turn on power to your audio devices in the order specified. Turning on devices in the wrong order may cause malfunction and/or damage to speakers and other devices.

1. Turn the **VOLUME knob to the minimum level (completely to the left).**
2. Turn on the **POWER switch.**
- * This unit is equipped with a protection circuit. A brief interval (a few seconds) after power up is required before the unit will operate normally.
3. While striking the head, gradually turn the **VOLUME knob to adjust the volume level.**

When Using with the Amp/Audio System

* To prevent malfunction and/or damage to speakers or other devices, always turn down the volume, and turn off the power on all devices before making any connections.

1. Turn down the volume control on each of the devices in your system.
2. Turn on the power of the RMP-5.
3. Turn on the connected amp or audio system, and adjust the volume to the desired level.

When Turning Off the Power

Before switching off the power, lower the volume on each of the devices in your system and then turn off the devices in the reverse order to which they were switched on.

About the Display

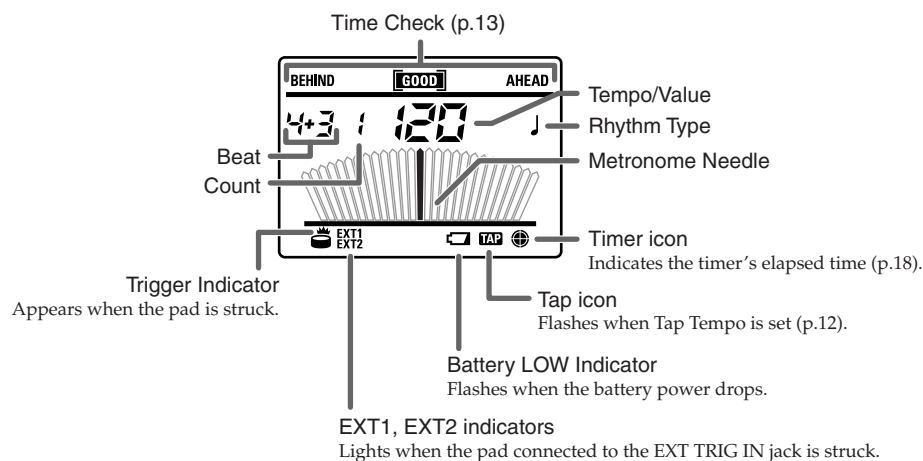

Practice

Changing the Sounds Assigned to the Pad

Changing these settings allows you to play a variety of different sounds.

1. Press the [METRONOME] button a number of times to select “1” (PAD SOUND).

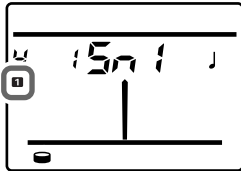

2. Press the [+] or [-] button to select the sound.

Sound List

Displayed	Sound Name		Displayed	Sound Name		Displayed	Sound Name	
Sn1	Snare 1 Vintage		EH2	Elec. Hi-Hat Open		tr2	Triangle Mute	
Sn2	Snare 2 Brass		EH3	Elec. Hi-Hat Close/Open		tr3	Triangle Mute/Open	
Sn3	Snare 3 Bright		rd1	Ride Cymbal Bow		Cb1	Cowbell Open	
Sn4	Snare 4 Funk		rd2	Ride Cymbal Bow/Bell		Cb2	Cowbell Mute	
Sn5	Snare 5 Piccolo		SPL	Splash		Cb3	Cowbell Mute/Open	
Sn6	Snare 6 Marching		t01	Tom Hi		tbr	Tambourine	
Pbd	Practice Board		t02	Tom Lo		Sha	Shaker	
ES1	Elec. Snare 1		tb1	Timbale Hi		bL1	Wood Block Hi	
ES2	Elec. Snare 2		tb2	Timbale Lo		bL2	Wood Block Lo	
K01	Kick 1 Rock	*3	tb3	Timbale Paila		bL3	Wood Block Lo/Hi	
K02	Kick 2 Hard	*3	Sd1	Surdo Open		CLA	Claves	
K03	Kick 3 Jazz	*3	Sd2	Surdo Mute		CrS	Snare Cross Stick	*1
EK1	Elec. Kick 1	*3	Sd3	Surdo Mute/Open	*2	S6r	Snare 6 Marching Rim	*1
EK2	Elec. Kick 2	*3	CAI	Caixa		Sh1	Snare 1 head sound only	*1
HH1	Hi-Hat Close		AG1	Agogo Hi		Sh2	Snare 2 head sound only	*1
HH2	Hi-Hat Open		AG2	Agogo Lo		Sh3	Snare 3 head sound only	*1
HH3	Hi-Hat Close/Open		AG3	Agogo Lo/Hi		Sh4	Snare 4 head sound only	*1
EH1	Elec. Hi-Hat Close		tr1	Triangle Open		Sh5	Snare 5 head sound only	*1

*1 Sounds suitable for use when a rim-shot-capable pad is connected and used in combination with the RMP-5 (p. 22).

*2 The “open” sound is easily produced by striking the pad with a stick and the “mute” sound is easily produced by striking with the palm of your hand.

*3 Kick pad sounds. Use these sounds when you have a KD-8/85/120 connected to the RMP-5.

This allows you to practice using both hands and your foot with the kick pad and RMP-5 (p. 19).

Using the Metronome

The metronome alternately starts and stops each time you press the [START/STOP] button.

Changing the Metronome Settings

You can change the metronome tempo, beat, rhythm type, sound, and volume.

1. Press the [METRONOME] button a few times to select the desired parameter.

The numbers shown at the left of the display indicate the parameters that are changed.

Parameter	Value
2 TEMPO	20–300
3 CLICK SOUND (Type of metronome sound)	C01: Traditional Metronome C09: Finger Snap C02: Simple Electric C10: Hi-Hat Close C03: Electric Beep C11: Hi-Hat Pedal C04: Cowbell C12: Ride Cymbal C05: Claves C13: Triangle C06: Sticks C14: Agogo C07: Voice Count C15: Tambourine C08: Hand Clap Ptn * * Selecting Ptn enables selection of patterns P01–P22 for the RHYTHM (Rhythm type) parameter. Using Ptn, you can easily select a metronome backing style for your workout.
4 RHYTHM (Rhythm type)	When C01–C15 is selected for CLICK SOUND:  When Ptn is selected for CLICK SOUND: P01: Triangle 16th * P12: Simple Surdo P02: Agogo 16th * P13: Wood Block & Shaker P03: Drum Simple 8 Beat P14: Agogo Triplet * P04: Drum Simple 16 Beat P15: 2-3 Son Clave * P05: Drum Shuffle P16: 3-2 Rumba Clave * P06: Drum Disco P17: Hi-Hat Open Close 1 P07: Jazz Legato Hi-Hat P18: Hi-Hat Open Close 2 P08: Jazz Legato Ride P19: Hi-Hat Open Close 3 P09: Jazz Count Hi-Hat P20: Hi-Hat Open Close 4 P10: Samba Kick P21: Hi-Hat Open Close 5 P11: Samba Surdo P22: Rock Fill Patterns indicated with an asterisk (*) can be created with a combination of the CLICK SOUND and RHYTHM.
5 BEAT	0–9, 2+3, 3+2, 3+4, 4+3, 4+5, 5+4, 5+6, 6+5, 6+7, 7+6, 7+8, 8+7, 8+9, 9+8
6 CLICK VOLUME (Metronome volume)	0 (Off)–15 (Max.)

2. Press the [+] or [-] button to set the values for each parameter.

3. Press the [START/STOP] button to turn the metronome on and off.



Adjusting the settings while the metronome is on helps you monitor the resulting change.



Hold down the [METRONOME] button and press the [-] button to have selections come up in the reverse order.



CLICK SOUND

A beep tone is played when nothing is connected to the OUTPUT jack. You can select beep sound from 1–2.



CLICK VOLUME

Adjusts the volume of the metronome sound that is heard when nothing is connected to the OUTPUT jack. You can select beep volume from 0–3.

Using Tap Tempo to Set the Metronome

You can set the metronome tempo by playing the on-board pad or any pad connected to the EXT TRIG IN jack.

1. Briefly hold down the [METRONOME] button.

The TAP icon appears in the display.

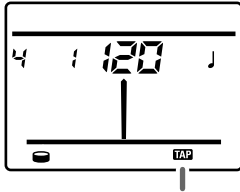

TAP icon

2. Strike the pad several times at the tempo of your choice.

The metronome's tempo is set according to quarter note timing.

3. If you press the [START/STOP] button, the metronome starts.

4. When you decide that the tempo is correct, press the [METRONOME] button to set the value.

The TAP icon disappears from the display.

MEMO

You can change the tempo with the [+] or [-] button when the TAP icon is showing in the display.

Using the Rhythm Coach Mode

The RMP-5's Rhythm Coach function is a unique set of exercises specifically designed to help build speed, accuracy, stamina, and better timing skills. The Rhythm Coach modes have programmable parameters, allowing you to adapt the functions to your specific needs.

Press the [COACH] button to switch to Rhythm Coach mode.

In this mode, after you press the [START/STOP] button to start the Rhythm Coach, your timing accuracy will always be indicated in the top of the display.

BEHIND ►►► [GOOD] ◀◀◀ AHEAD Dragging
 BEHIND ►►► [GOOD] ◀◀◀ AHEAD Perfect!
 BEHIND ►►► [GOOD] ◀◀◀ AHEAD Rushing

1. Press the [COACH] button a few times to select the desired function.

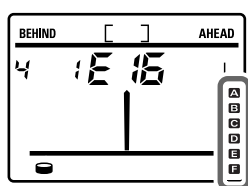

Parameter	Explanation	Value	Page
A TIME CHECK	Selecting Time Check mode	E-4, H-4, E-8, H-8, E-16, H-16, E-3, H-3	p. 14
B ACCURACY SCORE	Assigns a score indicating your timing accuracy	A-4, A-8, A-16, A-32	p. 14
C QUIET COUNT	Developing your internal timing sense	Q-1, Q-2, Q-4, Q-8, Q-16, Q-32	p. 15
D AUTO UP/DOWN	Tempo increase/decrease exercise	b-1, b-2, b-3, b-4, b-5, b-6	p. 15
E RHYTHMIC NOTES	Learning rhythmic note values	r-5, r-7, r-9	p. 16
F STROKE BALANCE	Checking the striking force (playing dynamics)	HLd, FL5	p. 16

2. Press the [+] or [-] button to select the exercise variation.
3. Press the [START/STOP] button to begin/finish the exercise.

MEMO

The sound set with the metronome is played (p. 11).

HINT

Hold down the [COACH] button and press the [-] button to have selections come up in the reverse order.

TIME CHECK

When you press the [COACH] button and switch to Rhythm Coach Mode, the Time Check result appears in the display. The Time Check mode setting made here is used with all other modes.

1. Press the [COACH] button a few times to select “**A**.”
2. Press the [+] or [-] button to select exercise variation.

Ε-4	Checks performance using relatively easier timing. (quarter note) (initial setting)
Η-4	Checks performance using more exact timing. (quarter note)
Ε-8	Checks performance using relatively easier timing. (8th-note)
Η-8	Checks performance using more exact timing. (8th-note)
Ε-16	Checks performance using relatively easier timing. (16th-note)
Η-16	Checks performance using more exact timing. (16th-note)
Ε-3	Checks performance using relatively easier timing. (16th-note triplets)
Η-3	Checks performance using more exact timing. (16th-note triplets)

3. Press the [START/STOP] button to begin the exercise.
4. When finished, press the [START/STOP] button again.

- * Regardless of how the metronome sound is played, the rhythm is checked according to the note timing set here.
- * To change the tempo during the exercise, press the [+] or [-] button.

ACCURACY SCORE

This mode will actually give you a “score” on your timing accuracy.

The result is indicated in the display.

1. Press the [COACH] button a few times to select “**B**.”
2. Press the [+] or [-] button to select exercise variation.

Α-4	Timing is checked over four measures. Then your score is displayed. (initial setting)
Α-8	Timing is checked over eight measures. Then your score is displayed.
Α-16	Timing is checked over sixteen measures. Then your score is displayed.
Α-32	Timing is checked over thirty-two measures. Then your score is displayed.

3. Press the [START/STOP] button to begin the exercise.

The Time Check function runs after a two-measure count-in.

The score is indicated in percentage points.

4. When finished, press the [START/STOP] button again.

- * Regardless of how the metronome sound is played, the rhythm is checked in accordance with the Time Check settings.
- * To change the tempo during the exercise, press the [+] or [-] button.

QUIET COUNT

In this mode, the metronome sound alternately switches between high and low volume levels according to the selected variation (the sound is practically inaudible when the volume drops). This cycle repeats until you press the [START/STOP] button to stop the exercise.

1. Press the [COACH] button a few times to select “**C**.”
2. Press the [+] or [-] button to select exercise variation.

C-1	1 measure cycle
C-2	2 measure cycle
C-4	4 measure cycle (initial setting)
C-8	8 measure cycle
C3 1	3 (with) plus 1 (quiet) measure cycle
C6 2	6 (with) plus 2 (quiet) measure cycle

3. Press the [START/STOP] button to begin the exercise.
4. When finished, press the [START/STOP] button again.

* To change the tempo during the exercise, press the [+] or [-] button.

AUTO UP/DOWN

AUTO UP/DOWN is designed to improve your playing stamina by increasing and then decreasing the metronome speed. The tempo will increase until it reaches the tempo you set. Then it will decrease until it reaches the starting tempo. This repeats until you press the [START/STOP] button.

1. Press the [COACH] button a few times to select “**D**.”
2. Press the [+] or [-] button to select exercise variation.

D-1	The tempo will increase and/or decrease by 1 BPM on every beat.
D-2	The tempo will increase and/or decrease by 1 BPM every two beats. (initial setting)
D-2	The tempo will increase and/or decrease by 2 BPM every eight measures.
D-5	The tempo will increase and/or decrease by 5 BPM every eight measures.
D-r	The tempo will increase and/or decrease every eight measures. The amount by which the tempo changes also increases as the tempo continues to increase. * When the tempo of the metronome is changed, it begins at the tempo closest to one of the predetermined starting tempos.
SPd	This is the Speed Check. With Speed Check, if you play correctly for eight measures, the RMP-5 will acknowledge this and advance 5 BPM faster. This continues until it reaches the metronome's maximum tempo. The exercise begins after a two-measure count-in. * When you play the passage accurately, the indicator flashes four times in the display, and the tempo increases by 5 BPM. If you do not play accurately, the indicator flashes twice, and remains at the same tempo for another eight measures.

3. Press the [START/STOP] button to begin the exercise.
4. When finished, press the [START/STOP] button again.

* After starting the click, you can set the desired maximum tempo by pressing [-] when it reaches the desired tempo. To clear the maximum tempo, press [+] (initial value: 300).

* When set to **SPd**, the maximum value for the tempo is fixed at 300.



This helps you to discover the tempos that are challenging for you.



What is BPM?

BPM is an abbreviation for “Beats Per Minute” (number of quarter-note beats in a one-minute period). Also means “tempo.”



When Speed Check is selected, the timing of the notes being checked and the degree of difficulty are determined in accordance with the Time Check settings (p. 14).

RHYTHMIC NOTES

RHYTHMIC NOTES is based on a traditional warm up exercise and also helps in learning rhythmic note values. After a two-measure count-in, the metronome plays through a series of note intervals or beat divisions. Each one is played for 2 measures before moving on to the next interval level. The exercise starts with half notes, stepping up through intervals to 16th note, 16th-note triplets or septuplets, and then back down to half notes again.

1. Press the [COACH] button a few times to select “E.”
2. Press the [+] or [-] button to select exercise variation.

r-5	Start  (initial setting)
r-7	Start 
r-9	Start 

3. Press the [START/STOP] button to begin the exercise.
4. When finished, press the [START/STOP] button again.

* To change the tempo during the exercise, press the [+] or [-] button.

MEMO

The “5” in r-5 refers to the number of changing rhythm types used.

STROKE BALANCE

This function checks the differences in playing dynamics between the right and left hands (or one hand).

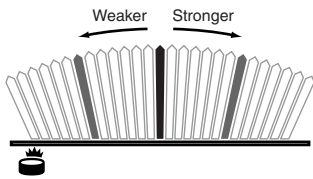

1. Press the [COACH] button a few times to select “F.”
2. Press the [+] or [-] button to select exercise variation.

HLS	The needle remains after striking. (initial setting)
FLS	The needle disappears right after striking.

3. Press the [START/STOP] button to turn the metronome on and off.

* To change the tempo during the exercise, press the [+] or [-] button.

* If you strike near the sensor, the needle shows “Stronger.”

Advanced Use

Triplet Time Check

Selecting "E-3" or "H-3" in TIME CHECK allows you to check triplet timing.

In this case, the timing of all of the triplet notes is checked.

You can use the following method to check only the timing of .

1. Set the metronome as shown below.

RHYTHM: , BEAT: 0

2. Select "E-4" or "H-4" in Time Check.

3. Begin practicing.

By hearing the metronome sound as the downbeat, you can check the timing of .

Metronome 
 Performance  **GOOD**

MEMO

"E" means EASY.

"H" means HARD.

Sixteenth-Note Offbeat Time Check

Selecting "E-16" or "H-16" in TIME CHECK allows you to check the timing of sixteenth-notes.

In this case, the timing of all of the sixteenth-notes is checked.

You can also use the following method to check the timing of the offbeats in sixteenth-notes only

(.

1. Set the metronome as shown below.

RHYTHM: , BEAT: 0

2. Select "E-8" or "H-8" in Time Check.

3. Begin practicing.

By hearing the metronome sound as the downbeat, you can check the timing of sixteenth-note offbeats.

Metronome 
 Performance  **GOOD**

Setting the Timer

This timer can be set from 1 to 60 minutes, letting you practice for the period of time you determine.

* You can use the Metronome and Rhythm Coach functions even while the timer is running.

1. Briefly hold down the [COACH] button.

The TIMER icon appears in the display.

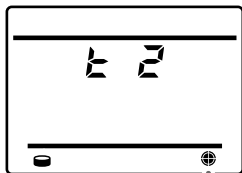

TIMER icon

2. Use the [+] or [-] button to select one of the timer options.

1 : 1 minute– 10 : 10 minutes

15 : 15 minutes

30 : 30 minutes

60 : 60 minutes

3. Press the [START/STOP] button to start the timer.

The timer icon flashes. A section of the fan shape will go off as each quarter of the set time elapses.

4. Pressing the [METRONOME] button at this point switches the RMP-5 to Metronome mode, and pressing the [COACH] button to Rhythm Coach mode.

Push the [START/STOP] button to begin.

5. When the set time has run out, the alarm sounds, and the BEAT indicator flashes.

* If you stop the metronome in a screen other than the Timer screen, the timer continues to run. To stop the timer, switch to the Timer screen and then press [START/STOP].



You can adjust the alarm volume in CLICK VOLUME.

Using the RMP-5 with Additional Pads

Setup Examples

Using an optional PCS-31L cable you can connect cymbal and kick pads to the EXT TRIG IN jack. Here's an example using the CY-8 and KD-8 pads.

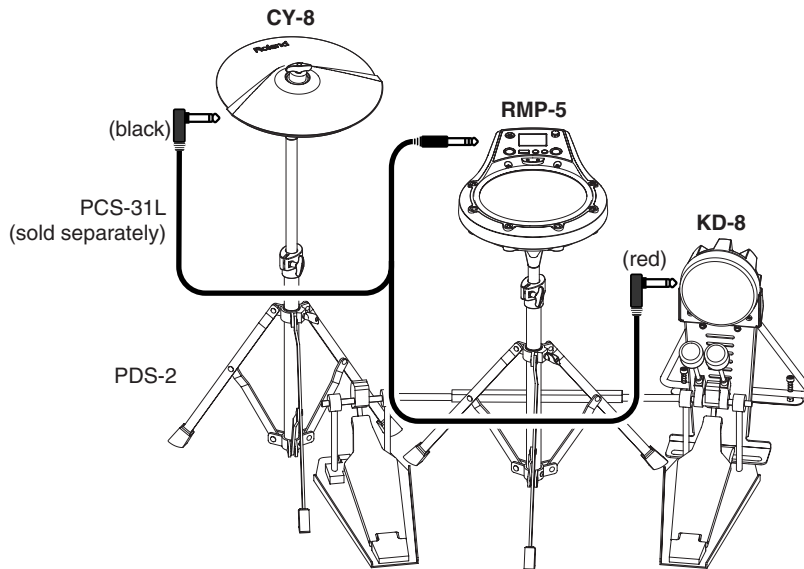

MEMO

The RMP-5 must be set to the following settings.
Input Mode (p. 20)

H-2

Trigger Type (p. 21)

EXT1: **CY8**

EXT2: **KD8**

* The above are default factory settings.

Connecting a Cymbal Pad

1. Connect the left (black) plug of the cable to the cymbal pad's output jack.

When you strike the pad, "EXT1" lights up.

- * Press the [METRONOME] button a number of times to select "1" (PAD SOUND), and use the [+] or [-] buttons to select the sound.

Precautions When Mounting the CY-8 on PDS-2

- * You can also use a normal cymbal stand
Attach as follows.

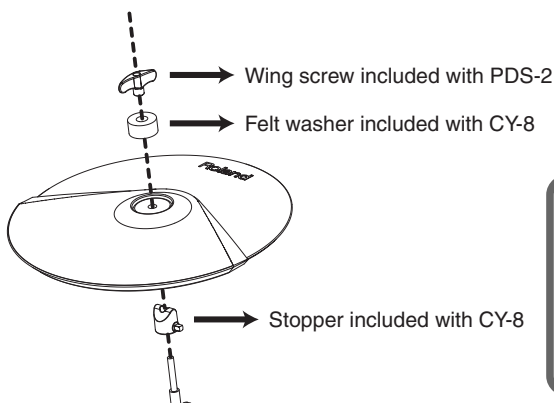

Do not use the wing nut included with the CY-8 or the washer included with the PDS-2.

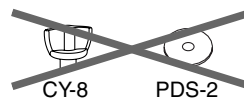

MEMO

Use the L-shaped cable to connect the cymbal pad.

NOTE

Cymbal pad edge shots and chokes cannot be played when both a cymbal pad and a kick trigger pad are connected to the External Trigger In jack.

Connecting a Kick Trigger Pad

1. Connect the right (red) plug of the cable to the kick trigger pad's output jack.

When you strike the pad, "EXT2" lights up.

- * Press the [METRONOME] button a number of times to select "1" (PAD SOUND), and use the [+] or [-] buttons to select the sound.

HINT

If connecting rim-shot-capable pads such as the PD-85 or PD-8, refer to "Connecting Pads Capable of Playing Rim Shots" (p. 22).

Connecting Other Pads

You can connect other Roland V-Drums Series pads as well. Depending on the trigger parameters, you can use two pads, or a single rim-capable pad. Because each pad has its own individual characteristics, you must first set the “trigger types” that correspond to the pad you are using in order for it to function correctly.

Connecting the Pads

1. Connect compatible pads to the External Trigger In jack.

2. While simultaneously holding down the [METRONOME] and [COACH] buttons, turn on the power.

The RMP-5 is now in the parameter setting mode.

3. Press the [+] or [-] button to switch the Input Mode to

M-2.

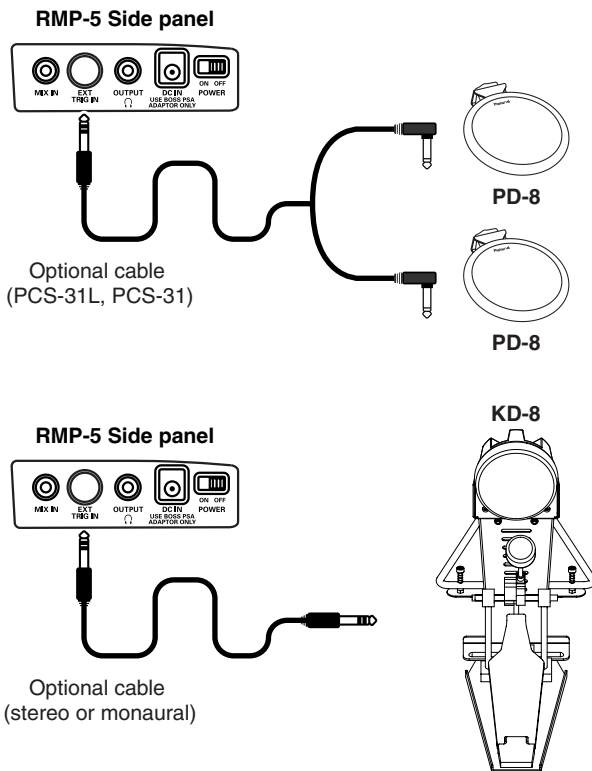

What is the Input Mode?
 Select whether or not to use rim-shot.
 When connecting two pads using the optional cable (PCS-31L or PCS-31), select *M-2* ;
 when connecting one pad that is capable of playing rim shots, select *M-r* .
 The default setting for this is *M-2* .

4. Press the [COACH] button.

Once *EXT* appears in the display, you can select the Trigger Type. Press the [+] or [-] button to select one of the following to match the pad you have connected.

Pad	Type	Pad	Type
PD-8	<i>PD8</i>	KD-120, KD-85, KD-80, KD-7	<i>kd</i>
PD-9, PD-7, PD-6	<i>PD</i>	CY-8	<i>CY8</i>
PD-85, PD-80R, PD-80	<i>85</i>	CY-15R, CY-14C, CY-12R/C, CY-12H, CY-6	<i>CY</i>
PD-105, PD-100	<i>105</i>	RT-7K	<i>RT7K</i>
PD-125, PD-120	<i>125</i>	RT-5S	<i>RT5S</i>
KD-8	<i>kd8</i>	RT-3T	<i>RT3T</i>

When you strike the pad, “EXT1” or “EXT2” flashes, indicating the pad being set. Confirm the selected pad and then set the trigger parameters.

MEMO

When connecting a cymbal pad and kick pad, refer to P.19.

MEMO

If connecting rim shot capable pads like a PD-85, PD-125 etc., refer to the next section, “Connecting Pads Capable of Playing Rim Shots” (p. 22).

MEMO

You cannot change the RMP-5 pad’s trigger type. This is indicated as “---” in the display.

What is the trigger type?

Trigger types are groups of parameters whose values are pre-adjusted for each type of pad. When you select the trigger type, these parameters are automatically set to the proper values, you can make fine adjustments to individual parameters for the pad if you want it to respond differently.

5. If necessary, press the [+] or [-] button to make fine adjustments to the trigger type parameters.

Press the [METRONOME] or [COACH] button to select the parameter, then press the [+] or [-] button to set the value.

6. Press the [START/STOP] button to return to the normal screen.

7. Set the pad sound.

While referring to “Changing the Sounds Assigned to the Pad” (p. 10), set the sound for the pad.



For more detailed information about each parameter, refer to the “Parameter List” (p. 23).

Connecting Pads Capable of Playing Rim Shots

1. Connect the compatible pad to the External Trigger In jack using **ONLY** a stereo cable.

2. While simultaneously holding down the [METRONOME] and [COACH] buttons, turn on the power.

The RMP-5 is now in the parameter setting mode.

3. Press the [+] or [-] button to switch the Input Mode to *H-r*.

4. Press the [COACH] button.

Once *ESP* appears in the display, you can select the Trigger Type.

Press the [+] or [-] button to select one of the following to match the pad you have connected.

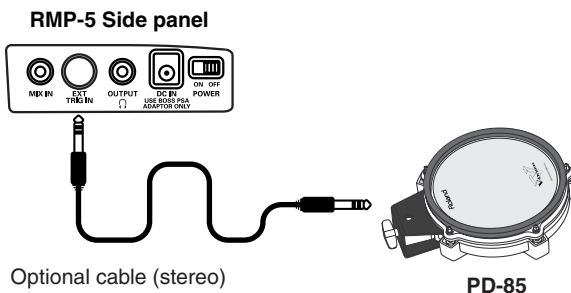

Pad	Type	Pad	Type
PD-8	<i>PdB</i>	PD-125, PD-120	<i>i25</i>
PD-9, PD-7	<i>Pd</i>	CY-8	<i>CyB</i>
PD-85, PD-80R	<i>85</i>	CY-15R, CY-14C, CY-12R/C, CY-12H, CY-6	<i>CY</i>
PD-105	<i>i05</i>	RT-5S	<i>t55</i>

5. If necessary, make fine adjustments to the trigger type parameters.

Press the [METRONOME] or [COACH] button to select the parameter, then press the [+] or [-] button to set the value.

* For more detailed information about each parameter refer to the “Parameter List” (p. 23).

6. Press the [START/STOP] button to return to the normal screen.

7. To set the sound for the head, strike the pad head.

The “EXT1” flashes.

8. Select the sound assigned to the head.

9. To set the rim sound, strike the pad’s rim.

The “EXT2” flashes.

10. Select the sound assigned to the rim.

* The following shows some recommended head and rim sound combinations (p. 10).

Head		Rim	
Sh1	Snare 1 head sound only	Sn1	Snare 1 Vintage
Sh2	Snare 2 head sound only	Sn2	Snare 2 Brass
Sh3	Snare 3 head sound only	Sn3	Snare 3 Bright
Sh4	Snare 4 head sound only	Sn4	Snare 4 Funk
Sh5	Snare 5 head sound only	Sn5	Snare 5 Piccolo
Sn6	Snare 6 Marching	S6r	Snare 6 March rim

Head		Rim	
Sh1	Snare 1 head sound only	CrS	Snare Cross Stick
Sh2	Snare 2 head sound only		
Sh3	Snare 3 head sound only		
Sh4	Snare 4 head sound only		
Sh5	Snare 5 head sound only		
Sn6	Snare 6 Marching		



Input Mode (p. 20)



Trigger Type (p. 21)

Parameter List

While simultaneously holding down the [METRONOME] and [COACH] buttons, turn on the power. Afterwards, press the [COACH] button to select the parameter, then press the [+] or [-] button to set the value.
 * Press the [METRONOME] button to have selections come up in the reverse order.

Parameter	Value		
Input Mode (displayed when turning on the power)	H-2 Head x 2 H-r Head&Rim	p. 20	
tzP Trigger Type	Pd8 PD-8 Pd PD-9, PD-7, PD-6 85 PD-85, PD-80R, PD-80 105 PD-105, PD-100 125 PD-125, PD-120 kd8 KD-8 kd KD-120, KD-85, KD-80, KD-7	CY8 CY-8 CY CY-15R, CY-14C, CY-12R/C, CY-12H, CY-6 RT7K RT-7K RT5S RT-5S RT3T RT-3T —	p. 21
Sns Sensitivity	1-16	p. 23	
thr Threshold	0-15	p. 23	
Vel Velocity Curve	Lin , LG2 , EP1 , SPL , EP2 , Ld1 , LG1 , Ld2	p. 23	
Scn Scan Time	0-4.0 ms (adjustable in increments of 0.1 ms)	p. 24	
rtc Retrigger Cancel	1-16	p. 24	
crs Crosstalk Cancel	off , 20-80 (adjustable in increments of 5)	p. 24	
msk Mask Time	0-64 ms (adjustable in increments of 4 ms)	p. 25	
rns Rim Sensitivity*	off , 1-20, ---	p. 25	
rnG Rim Gain	0.5-20, ---	p. 25	

Sensitivity

This adjustment determines the pad's response. Higher values means higher sensitivity, and the pad will produce a loud sound even when played softly.

* When you strike the pad, your playing velocity is shown in the display. Set the value so that the needle appears at the far right when you strike the pad with maximum velocity.

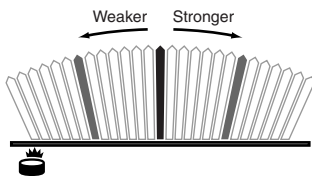

Threshold

This setting allows the trigger signal to be received only if the pad is played harder than a specified dynamic. This can be used to prevent the pad from sounding due to extraneous vibrations from another pad. In the following example, B will sound but A and C will not sound.

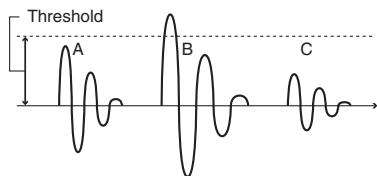

When set to a higher value, no sound is produced when the pad is struck lightly.

Gradually raise the Threshold value while striking the pad. Check this and adjust accordingly. Repeat this process until you get the perfect setting for your playing style.

Velocity Curve

This determines volume changes corresponding to your playing velocity.

Lin (Linear)

This is the normal setting and produces the most natural correspondence between playing dynamics and changes in volume.

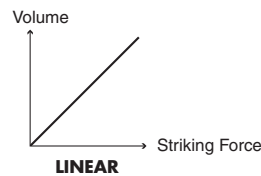

EP1, EP2 (Exponential 1, Exponential 2)

Compared to Linear, a wider volume change will occur for stronger hits.

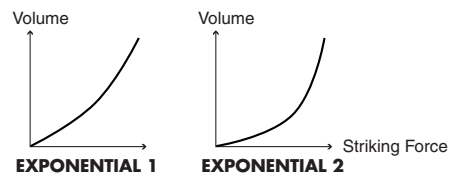

LG1, LG2 (Log 1, Log 2)

Compared to Linear, wider volume change will occur for softer hits.

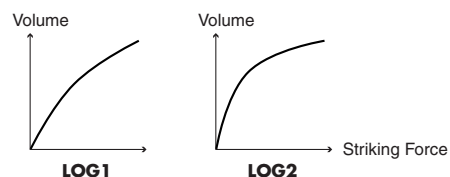

Using the RMP-5 with Additional Pads

SPL (Spline)

Variation in playing dynamics produces extreme changes.

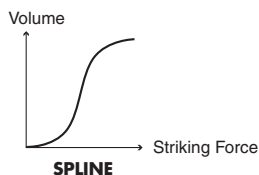

Ld1, Ld2 (Loud 1, Loud 2)

Variation in playing dynamics produces little change, and a constant volume is maintained. If using drum triggers, these settings help maintain stable levels.

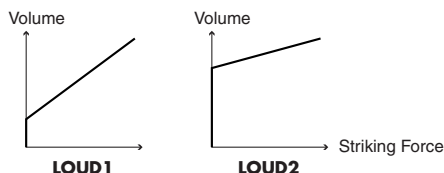

Scan Time

Since the rise time of the trigger signal waveform may differ slightly depending on the characteristics of each pad or acoustic drum trigger (drum pickup), you may notice that identical hits (velocity) produce sound at different volumes.

If this occurs, you can adjust the Scan Time so that your playing velocity can be detected more precisely.

As the value is set higher, the time it takes for the sound to be played increases. Set this to as low a value as you can.

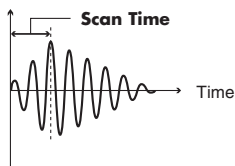

Making the settings

While repeatedly hitting the pad at a constant strength, gradually raise the Scan Time value from 0 msec, until the resulting volume stabilizes at the loudest level. At this setting, try both soft and loud strikes, and make sure that the volume changes appropriately.

- * When you strike the pad, the strength with which the pad is struck (velocity) is shown in the display.
Set the value so that the needle appears at the far right when you strike the pad with maximum velocity.

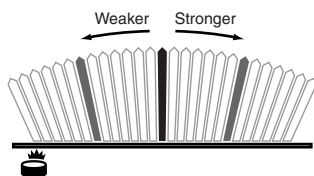

Retrigger Cancel

Altered waveforms may cause inadvertent sounding at Point A in the following figure (This is called retrigger).

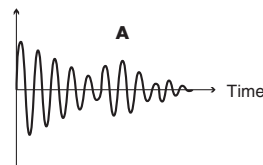

This can occur at the decaying edge of the waveform. Retrigger Cancel detects such distortion and basically eliminates retriggering. Although setting this to a high value prevents retriggering, it then becomes easy for sounds to be omitted when playing fast (buzz roll etc.).

Set this to the lowest value possible while still ensuring that there is no retriggering.

- * You can also eliminate this problem of retriggering with the Mask Time setting. Mask Time does not detect trigger signals if they occur within the specified amount of time after the previous trigger signal was received. Retrigger Cancel detects the attenuation of the trigger signal level, and triggers the sound after internally determining which trigger signals were actually generated when the head was struck, while weeding out the other false trigger signals that need not trigger a sound.

Making the settings

While repeatedly striking the pad, raise the Retrigger Cancel value until retriggering no longer occurs.

Crosstalk Cancel

When two pads are mounted on the same stand, vibrations from one pad may trigger the sound from the second pad unintentionally (This is called crosstalk.)

To avoid this, adjust the Crosstalk Cancel on the pad that is sounding inadvertently.

If the value is set too high, then when two pads are played simultaneously, the one that is struck less forcefully will not sound. Be careful and set this parameter to the minimum value required to prevent such crosstalk. With a setting of "OFF," crosstalk prevention does not function.

- * You can also prevent crosstalk between two pads by increasing the distance between the pads or by raising the Threshold value.
- * You cannot prevent crosstalk from pads connected to another drum module. Increase the distance between such pads, or raise the Threshold.

Making the settings

If you hit the pad connected to the EXT1, and the pad connected to the EXT2 also sounds, then raise the Crosstalk Cancel value from "OFF" for the pad connected to EXT2 while striking the pad connected to EXT1 until crosstalk no longer occurs.

Mask Time

Example when using a kick trigger pad; if the beater bounces back and hits the pad a second time immediately after the intended stroke or if you leave the bass drum beater against the pad—it can cause “double triggering” (two sounds instead of the intended one). The Mask Time setting helps to prevent such problems. Once a pad has been hit, additional trigger signals occurring within the specified Mask Time (0–64 msec) will be ignored.

If set to a high value, then sounds may be omitted when you intentionally play a very fast phrase (like with a double bass drum pedal). Set this to as low a value as possible.

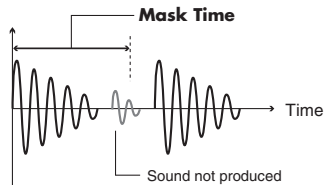

* If two or more sounds are being produced when you strike the pad just once, then adjust Retrigger Cancel.

Rim Sensitivity

When using a pad capable of playing rim shots, you can adjust the Rim Sensitivity.

Setting this to a higher value makes it easier to trigger the sound assigned to the rim. If set to “OFF,” striking the rim will produce the sound assigned to the head. If the value is set too high, then striking the head, may also trigger the sound assigned to the rim.

* This setting can be made only with the following Trigger Type (p. 21) settings selected (refer to Rim Gain).

Rim Gain

This adjusts the relation between playing velocity on the rim/edge and the resulting volume level.

* This setting adjusts only the rim. Adjust the balance between velocity and volume for the overall pad with the “Sensitivity” setting (p. 23).

* This setting can be made only with the following Trigger Type (p. 21) settings selected.

Trigger Type	Rim Sensitivity	Rim Gain
PdB	—	✓
Pd	—	✓
85	✓	✓
105	✓	✓
125	✓	✓
C48	—	✓
C4	—	✓
t55	✓	✓

* This can be adjusted only when the Input Mode is set to H-r .

Appendices

Adjusting the Pad Sensitivity

When practicing with Stroke Balance, if you think that the needle swings too much or too little, then adjust the head sensitivity.

1. While simultaneously holding down the [METRONOME] and [COACH] buttons, turn on the power.

2. Press the [COACH] button twice.

The display shows " 505 ."

3. Press the [+] or [-] button to adjust the sensitivity. (initial setting: 6)

Setting this to a higher value makes the sensitivity higher.

4. When finished, press the [START/STOP] button.

The setting is stored, and then the RMP-5 returns to the normal screen.

Restoring the Factory Settings

This restores the RMP-5 to the original factory settings.

1. Hold down the [START/STOP] button and turn on the power.

The display shows " r5t ."

2. Press the [START/STOP] button again and keep pressing to restore the factory settings.

All settings are returned to the default factory settings.

When the procedure is finished, the RMP-5 returns to the normal screen.

The RMP-5's head is set at the factory with the following values.

505 (Sensitivity):	5
t5r (Threshold):	2
Lnr (Velocity Curve):	Lnr
Scn (Scan Time):	16
r5t (Retrigger Cancel):	3
LrS (Crosstalk Cancel):	off
n5t (Mask Time):	4

If an Error Message Appears

This section lists the different error messages that may appear, along with their meanings and measures to resolve the problems described.

Display	Meaning	Action
Er 1	Data in the RMP-5's memory may be corrupted.	" r5t " appears when the [METRONOME] button is pressed. Press the [METRONOME] button once again and keep pressing to execute the Factory Reset. Only the settings for the corrupted portion are subject to Factory Reset (doing so will erase any changes you have made). If this does not resolve the problem, consult your Roland dealer or nearest Roland Service Center.
Er 2	A problem has occurred with the internal system.	Consult your Roland dealer or nearest Roland Service Center.

Replacing the Head

If the head has been damaged or no longer maintains correct tension, replace it.

To order replacement heads (#03891812 RMP-3 PAD HEAD(MESH HEAD) <CM-2208-RN>), contact the retailer from whom you purchased the RMP-5 or the nearest Roland Service Center.



The MH-8 Mesh Head is not compatible and cannot be used.

Replacing the Head

When replacing or tuning, use the included tuning key.

1. Remove all tuning bolts.

Gradually loosen each one in order, turning them counterclockwise.

* *Do not lose the tuning bolts.*

2. Open the case, and then remove the old head.

3. Place the new head in the case.

4. Securely close the case.

5. Attach all eight tuning bolts.

6. Adjust the tension of the head. Refer to “Adjusting the Head Tension” (p. 7).

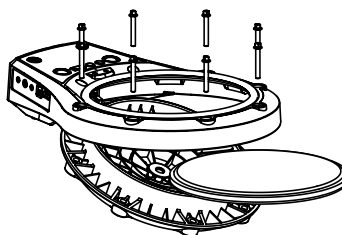

Specifications

RMP-5: Rhythm Coach

- **Pad Size**

8 inches

- **Pad Sounds**

54 types

- **Tempo**

20–300

- **Click Sounds**

15 types

- **Rhythm Types**

24 types

- **Patterns**

22 types

- **Beat**

24 types

- **Rhythm Coach functions**

TIME CHECK (8 variations)

ACCURACY SCORE (4 variations)

QUIET COUNT (6 variations)

AUTO UP/DOWN (6 variations)

RHYTHMIC NOTES (3 variations)

STROKE BALANCE (2 variations)

- **Connectors**

PHONES/OUTPUT Jack: 1 (Stereo miniature phone type)

AC Adaptor Jack

MIX IN Jack: 1 (Miniature phone type)

EXT TRIG IN Jack: 1 (Dual)

* Using the PCS-31L, you can connect two pads. In that case, the rim shot, edge shot, and choking features are unavailable.

- **Power Supply**

DC 9 V: Dry Battery 6LR61/1604A (9 V) type (alkaline)

AC Adaptor

- **Current Draw**

80 mA

* Expected battery life under continuous use:

Carbon: 1 hour

Alkaline: 4 hours

These figures will vary depending on the actual conditions of use.

* We recommend replacement with alkaline batteries.

* The batteries included with the RMP-5 are intended to provide confirmation that the unit functions properly. Battery life may be shorter than that indicated above.

- **Stand Screw Size**

M8

- **Dimensions**

263 (W) x 348 (D) x 78 (H) mm

10-3/8 (W) x 13-3/4 (D) x 3-1/8 (H) inches

- **Weight**

1.3 kg / 2 lbs 14 oz (including a battery)

- **Accessories**

Dry Battery 6LR61/1604A (9 V) type (alkaline)

Tuning Key

Owner's Manual

- **Options**

AC Adaptor: BOSS PSA series

Pad Stand: PDS-2

Pad Cable: PCS-31L

Pads (PD-8, PD-85BK/WT, PD-105BK/WT, PD-125BK/WT)

Cymbals (CY-8, CY-12R/C, CY-14C, CY-15R)

Kick Triggers (KD-8, KD-7, KD-85BK/WT, KD-120BK/WT)

Drum Triggers (RT-3T, RT-5S, RT-7K)

* In the interest of product improvement, the specifications and/or appearance of this unit are subject to change without prior notice.

Sample Practice Patterns

Following, you will find a variety of basic practice patterns to use with the Rhythm Coach. Suggested tempos and settings for the RMP-5 will not only guide you, but challenge you to improve all aspects of your playing skills.

We also recommend that you make your own variations by writing in ACCENTS, or changing the sticking patterns.

If you are working with a drum teacher, he or she can also help you get more out of the RMP-5's Rhythm Coach functions.

Sample Practice Patterns

Exercise 1 (TIME CHECK — Quarter Notes)

Make the following settings.

PAD SOUND: Sn1 (Snare 1 Vintage)
TEMPO: 120
CLICK SOUND: C01
RHYTHM: 
BEAT: 4
CLICK VOLUME: 10
TIME CHECK: E-4

MEMO

When TIME CHECK is set to "H-4," the timing is strictly checked. If set to "E-4" it's a little easier. Remember, "H" means hard, and "E" means easy.



* Practice until [GOOD] lights up in the display consistently.
Change the tempo for further challenges.

Exercise 2 (TIME CHECK — 16th Note)

Make the following settings.

TIME CHECK: E16



* Practice until [GOOD] lights up in the display consistently.
Change the tempo for further challenges.

Exercise 3 (TIME CHECK — Triplets)

Make the following settings.

TIME CHECK: E-3



* Practice until [GOOD] lights up in the display consistently.
Change the tempo for further challenges.

Exercise 4 (STROKE BALANCE)

Make the following settings.

TEMPO: 120
RHYTHM: 
BEAT: 4
TIME CHECK: E-8
STROKE BALANCE: HLd

MEMO

Remember that the Time Check function is always operating.



* Work hard to get equal dynamics with both your hands.

Exercise 5 (RHYTHMIC NOTES)

Make the following settings.

TEMPO: 100

BEAT: 4

RHYTHMIC NOTES: r-9

These exercises are VERY important for developing control and timing sense.

Practice them at various dynamic levels as well.

* When "r-7" is selected for RHYTHMIC NOTES, the following seven patterns are repeated.

* When "r-5" is selected for RHYTHMIC NOTES, the following five patterns are repeated.

Sample Practice Patterns

Exercise 6 (QUIET COUNT — q-2)

Make the following settings.

TEMPO: 112
 RHYTHM: 
 BEAT: 4
 TIME CHECK: E-8
 QUIET COUNT: q-2

Metronome 

Performance 

RLRLRLRL RLRLRLRL RLRLRLRL RLRLRLRL
 (LRLRLRLR LRLRLRLR LRLRLRLR LRLRLRLR)

* Once you have mastered this, try starting with the left hand and also vary the tempo.

Exercise 7 (QUIET COUNT — q31)

Make the following settings.

TEMPO: 140
 RHYTHM: 
 BEAT: 4
 TIME CHECK: E16
 QUIET COUNT: q31

Metronome 

Performance 

R L R L R L R L R L R L R L RLRLRLRLRLRLRLRLRLRL

Exercise 8 (AUTO UP/DOWN — b-2)

Make the following settings.

TEMPO: 100
 RHYTHM: 
 BEAT: 4
 TIME CHECK: H-4
 AUTO UP/DOWN: b-2

 (Single Paradiddle)

RLRRLRLLRLRRLRLL RLRLRLLLRLRRLRLL

* You can set the tempo's upper limit by pressing "-" while the tempo is increasing.

Exercise 9 (AUTO UP/DOWN — 8-5)

Make the following settings.

TEMPO: 100
 RHYTHM: 
 BEAT: 4
 TIME CHECK: E16
 AUTO UP/DOWN: 8-5

 (Double Stroke)

RRLLRLLRLLRLL RRLLRLLRLLRLL

* You can set the tempo's upper limit by pressing "-" while the tempo is increasing.

Exercise 10 (AUTO UP/DOWN — SPd)

Make the following settings.

TEMPO: 90
 RHYTHM: 
 BEAT: 4
 TIME CHECK: E-8
 AUTO UP/DOWN: SPd



RLRLRLL RLRLRLL

Exercise 11 (Practicing in Time with Patterns)

Make the following settings.

PAD SOUND: tb1 (Timbale Hi)
 TEMPO: 110
 CLICK SOUND: Ptn
 RHYTHM: P10 (Samba Kick)
 BEAT: 4
 CLICK VOLUME: 12
 TIME CHECK: E16



RLRLRLRLRLRLRLRL RLRLRLRLRLRLRLRL

INDEX

A

- AC Adaptor jack 6
- ACCURACY SCORE 13-14
- AUTO UP/DOWN 13, 15

B

- Battery 7
- Battery LOW indicator 7
- BEAT
 - Indicator 6
 - Metronome 11

C

- CLICK SOUND 11
- CLICK VOLUME 11
- COACH button 6
- Connecting
 - Cymbal pad 19
 - Kick trigger pad 19
 - Other pads 20
 - Pads capable of playing rim shots 22
- Crosstalk cancel 24, 26

D

- Display 9

E

- Error messages 26
- EXT TRIG IN jack 6

H

- Head 6
 - Replacing 27
 - Tension 7

I

- Input mode 20

M

- Mask time 25-26
- Metronome 11
- METRONOME button 6
- Mini speaker 6
- MIX IN jack 6

O

- OUTPUT jack 6

P

- Pad
 - Sensitivity 26
- PAD SOUND 10
- Parameter list 23
- Power 9
- POWER switch 6

Q

- QUIET COUNT 13, 15

R

- Restoring
 - Factory settings 26
- Retrigger cancel 24, 26
- RHYTHM 11
- Rhythm coach mode 13
- RHYTHMIC NOTES 13, 16
- Rim gain 25
- RIM SENSITIVITY 25
- Rim sensitivity 25

S

- Scan Time 24, 26
- Sensitivity 23, 26
 - Head 26
- Sensor 6
- Sound list 10
- Specifications 28
- START/STOP button 6
- STROKE BALANCE 13, 16

T

- Tap tempo 12
- TEMPO 11
- Threshold 23, 26
- TIME CHECK 13-14
- Time Check
 - Sixteenth Triplet Offbeat 17
 - Triplet 17
- Timer 18
- Trigger type 21
- Tuning bolts 6

V

- VALUE +/- button 6
- Velocity curve 23, 26
- VOLUME 11
- VOLUME knob 6

For the U.K.

IMPORTANT: THE WIRES IN THIS MAINS LEAD ARE COLOURED IN ACCORDANCE WITH THE FOLLOWING CODE.

BLUE: NEUTRAL
BROWN: LIVE

As the colours of the wires in the mains lead of this apparatus may not correspond with the coloured markings identifying the terminals in your plug, proceed as follows:

The wire which is coloured BLUE must be connected to the terminal which is marked with the letter N or coloured BLACK.
The wire which is coloured BROWN must be connected to the terminal which is marked with the letter L or coloured RED.
Under no circumstances must either of the above wires be connected to the earth terminal of a three pin plug.

For EU Countries



This product complies with the requirements of European Directive 89/336/EEC.

For the USA

FEDERAL COMMUNICATIONS COMMISSION RADIO FREQUENCY INTERFERENCE STATEMENT

This equipment has been tested and found to comply with the limits for a Class B digital device, pursuant to Part 15 of the FCC Rules. These limits are designed to provide reasonable protection against harmful interference in a residential installation. This equipment generates, uses, and can radiate radio frequency energy and, if not installed and used in accordance with the instructions, may cause harmful interference to radio communications. However, there is no guarantee that interference will not occur in a particular installation. If this equipment does cause harmful interference to radio or television reception, which can be determined by turning the equipment off and on, the user is encouraged to try to correct the interference by one or more of the following measures:

- Reorient or relocate the receiving antenna.
- Increase the separation between the equipment and receiver.
- Connect the equipment into an outlet on a circuit different from that to which the receiver is connected.
- Consult the dealer or an experienced radio/TV technician for help.

This device complies with Part 15 of the FCC Rules. Operation is subject to the following two conditions:

- (1) This device may not cause harmful interference, and
- (2) This device must accept any interference received, including interference that may cause undesired operation.

Unauthorized changes or modification to this system can void the users authority to operate this equipment.
This equipment requires shielded interface cables in order to meet FCC class B Limit.

For Canada

NOTICE

This Class B digital apparatus meets all requirements of the Canadian Interference-Causing Equipment Regulations.

AVIS

Cet appareil numérique de la classe B respecte toutes les exigences du Règlement sur le matériel brouilleur du Canada.

PAD SOUND

Sn1	Snare 1 Vintage	EH2	Elec. Hi-Hat Open	tr2	Triangle Mute
Sn2	Snare 2 Brass	EH3	Elec. Hi-Hat Close/Open	tr3	Triangle Mute/Open
Sn3	Snare 3 Bright	rd1	Ride Cymbal Bow	Cb1	Cowbell Open
Sn4	Snare 4 Funk	rd2	Ride Cymbal Bow/Bell	Cb2	Cowbell Mute
Sn5	Snare 5 Piccolo	SPL	Splash	Cb3	Cowbell Mute/Open
Sn6	Snare 6 Marching	t01	Tom Hi	tbr	Tambourine
Pbd	Practice Board	t02	Tom Lo	Sha	Shaker
ES1	Elec. Snare 1	tb1	Timbale Hi	bL1	Wood Block Hi
ES2	Elec. Snare 2	tb2	Timbale Lo	bL2	Wood Block Lo
K01	Kick 1 Rock	tb3	Timbale Paila	bL3	Wood Block Lo/Hi
K02	Kick 2 Hard	Sd1	Surdo Open	CLA	Claves
K03	Kick 3 Jazz	Sd2	Surdo Mute	CrS	Snare Cross Stick
EK1	Elec. Kick 1	Sd3	Surdo Mute/Open	S6r	Snare 6 Marching Rim
EK2	Elec. Kick 2	CAI	Caixa	Sh1	Snare 1 head sound only
HH1	Hi-Hat Close	AG1	Agogo Hi	Sh2	Snare 2 head sound only
HH2	Hi-Hat Open	AG2	Agogo Lo	Sh3	Snare 3 head sound only
HH3	Hi-Hat Close/Open	AG3	Agogo Lo/Hi	Sh4	Snare 4 head sound only
EH1	Elec. Hi-Hat Close	tr1	Triangle Open	Sh5	Snare 5 head sound only

CLICK SOUND

C01	Traditional Metronome	C11	Hi-Hat Pedal
C02	Simple Electric	C12	Ride Cymbal
C03	Electric Beep	C13	Triangle
C04	Cowbell	C14	Agogo
C05	Claves	C15	Tambourine
C06	Sticks	Ptn	
C07	Voice Count		
C08	Hand Clap		
C09	Finger Snap		
C10	Hi-Hat Close		

RHYTHM (Pattern)

P01	Triangle 16th	P11	Samba Surdo	P21	Hi-Hat Open Close 5
P02	Agogo 16th	P12	Simple Surdo	P22	Rock Fill
P03	Drum Simple 8 Beat	P13	Wood Block & Shaker		
P04	Drum Simple 16 Beat	P14	Agogo Triplet		
P05	Drum Shuffle	P15	2-3 Son Clave		
P06	Drum Disco	P16	3-2 Rumba Clave		
P07	Jazz Legato Hi-Hat	P17	Hi-Hat Open Close 1		
P08	Jazz Legato Ride	P18	Hi-Hat Open Close 2		
P09	Jazz Count Hi-Hat	P19	Hi-Hat Open Close 3		
P10	Samba Kick	P20	Hi-Hat Open Close 4		

