

Contents

1	Instructions	44
1.1	General safety instructions	44
1.2	Manufacturer liability	45
1.3	Appliance purpose	45
1.4	Disposal	45
1.5	Identification plate	46
1.6	This user manual	46
1.7	How to read the user manual	46
2	Description	47
2.1	General Description	47
2.2	Control panel	48
2.3	Other parts	48
2.4	Available accessories	49
3	Use	51
3.1	Instructions	51
3.2	First use	51
3.3	Using the accessories	52
3.4	Using the oven	53
3.5	Cooking advice	60
3.6	Special functions	62
3.7	Secondary menu	65
4	Cleaning and maintenance	68
4.1	Instructions	68
4.2	Cleaning the appliance	68
4.3	Removing the door	68
4.4	Cleaning the door glazing	69
4.5	Vapor Clean (on some models only)	72
4.6	Pyrolytic function (on some models only)	75
4.7	Extraordinary maintenance	77
5	Installation	79
5.1	Electrical connection	79
5.2	Cable replacement	79
5.3	Positioning	80

We advise you to read this manual carefully, which contains all the instructions for maintaining the appliance's aesthetic and functional qualities.

For further information on the product: www.smeg.com



Instructions

1 Instructions

1.1 General safety instructions

Risk of personal injury

- During use the appliance and its accessible parts become very hot.
- Never touch the heating elements during use.
- Keep children under eight years of age at a safe distance if they are not constantly supervised.
- Children must never play with the appliance.
- Never rest metallic objects such as knives, forks, spoons and lids on the appliance during use.
- Switch off the appliance immediately after use.
- Never try to put out a fire or flames with water: Turn off the appliance and smother the flames with a fire blanket or other appropriate cover.
- The appliance must never be cleaned by unsupervised children.
- Have qualified personnel carry out installation and assistance interventions according to the standards in force.
- Do not modify this appliance.

- Do not insert pointed metal objects (cutlery or utensils) into the slots in the appliance.
- Do not try to repair the appliance yourself or without the intervention of a qualified technician.
- If the power supply cable is damaged, contact technical support immediately and they will replace it.

Risk of damaging the appliance

- Do not use abrasive or corrosive detergents (e.g. scouring powders, stain removers and metallic sponges) on glass parts.
- Use wooden or plastic utensils.
- Do not seat on the appliance.
- Do not use steam jets to clean the appliance.
- Do not obstruct ventilation openings and heat dispersal slots.
- Never leave the appliance unattended during cooking operations where fats or oils could be released.
- Never leave objects on the cooking surface.
- Do not use the appliance to heat rooms for any reason.



For this appliance

- Ensure that the appliance is switched off before replacing the bulb.
- Do not rest any weight or sit on the open door of the appliance.
- Take care that no objects are stuck in the doors.

1.2 Manufacturer liability

The manufacturer declines all liability for damage to persons or property caused by:

- Use of the appliance other than that specified;
- Non-observance of the user manual provisions;
- Tampering with any part of the appliance;
- Use of non-original spare parts.

1.3 Appliance purpose

- This appliance is intended for cooking food in the home environment. Every other use is considered improper.
- This appliance may be used by children aged at least 8 and by people of reduced physical or mental capacity, or lacking in experience in the use of electrical appliances, provided that they are supervised or instructed by adults who are responsible for their safety.
- The appliance is not designed to operate with external timers or with remote-control systems.

1.4 Disposal



This appliance must be disposed of separately from other waste (Directives 2002/95/EC, 2002/96/EC, 2003/108/EC). The appliance does not contain substances in quantities sufficient to be considered hazardous to health and the environment, in accordance with current European directives.

To dispose of the appliance:

- Cut the power supply cable and remove it along with the plug.



Power voltage

Danger of electrocution

- Disconnect the main power supply.
- Disconnect the power cable from the electrical system.
- Deliver the appliance to the appropriate recycling centre for electrical and electronic equipment waste, or return it to the retailer when purchasing an equivalent product, on a one for one basis.



Instructions

Our appliances are packed in non-polluting and recyclable materials.

- Deliver the packing materials to the appropriate recycling centre.



Plastic packaging Danger of suffocation

- Do not leave the packaging or any part of it unattended.
- Do not let children play with the packaging plastic bags.

1.5 Identification plate

The identification plate bears the technical data, serial number and brand name of the appliance. Do not remove the identification plate for any reason.

1.6 This user manual

This user manual is an integral part of the appliance and must therefore be kept in its entirety and within the user's reach for the whole working life of the appliance.

Read this user manual carefully before using the appliance.

1.7 How to read the user manual

This user manual uses the following reading conventions:

Instructions



General information on this user manual, on safety and final disposal.

Description



Description of the appliance and its accessories.

Use



Information on the use of the appliance and its accessories, cooking advice.

Cleaning and maintenance



Information for proper cleaning and maintenance of the appliance.

Installation



Information for the qualified technician: Installation, operation and inspection.



Safety instructions



Information



Advice

1. Sequence of instructions for use.

- Standalone instruction.



2 Description

2.1 General Description

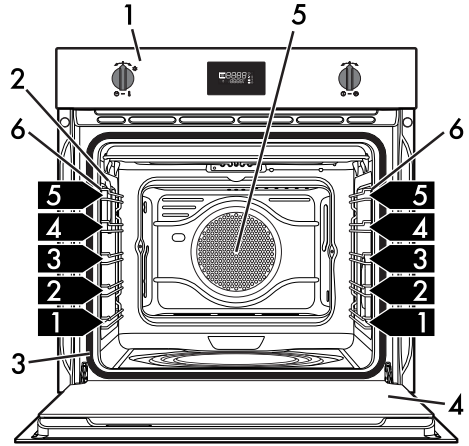
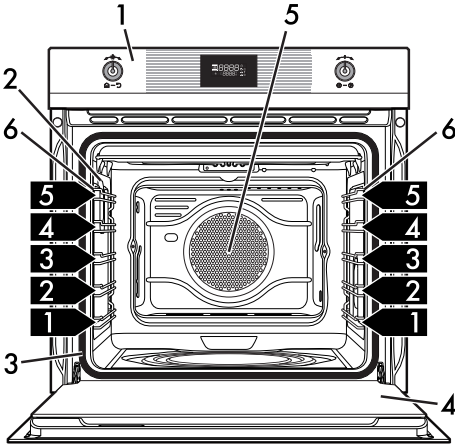

Multifunction/Pyrolytic models

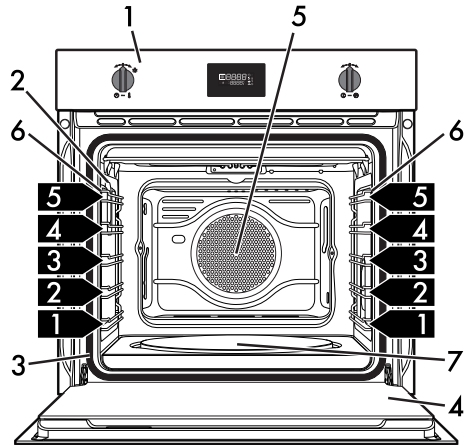
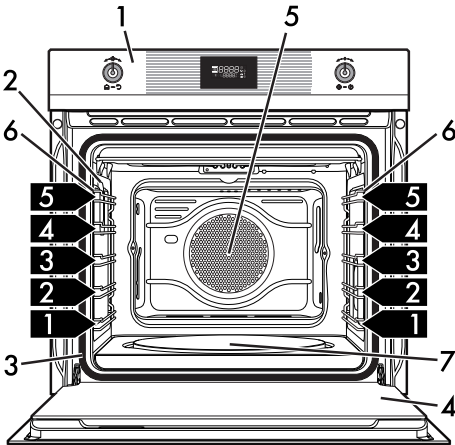

Models with pizza plate

- 1 Control panel
- 2 Oven light
- 3 Seal
- 4 Door

- 5 Fan
- 6 Rack/tray support frames
- 7 Pizza plate (on some models only)

1,2,3 Frame shelf

EN



Description

2.2 Control panel

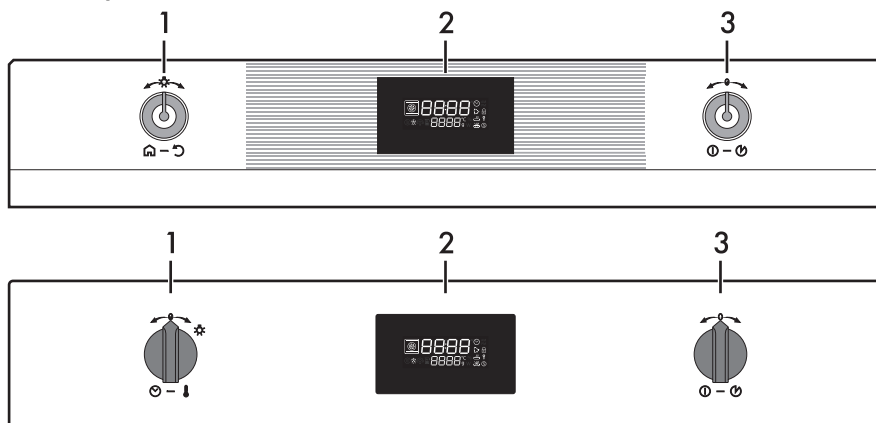

1 Programming knob

This knob can be used to select:

- The cooking temperature
- The duration of a function
- Programmed cooking procedures
- The current time
- Turning on or off of the light inside the appliance.

1 Display

Displays the current time, the selected cooking temperature, power and function and any time set.

3 Function knob

This knob can be used to:

- Turn the appliance on and off
- Select a function
- Temporarily start or stop a function.

2.3 Other parts

Interior lighting

The appliance interior lighting comes on:

- When the door is opened (on some models only).
- When any function is selected, apart from the **Pyro**, **PECo** and **CLEA** functions (where present)
- When no function is selected, turn the programming knob briefly to the right to activate or deactivate internal lighting.



In order to save energy, the light turns off after a minute at the start of cooking (this function can be deactivated via the secondary menu).



Press and hold the function knob down for around 3 seconds to immediately terminate any cooking operation.



Shelves

The appliance features shelves to position trays and racks at different heights. The insertion heights are indicated from the bottom upwards (see 2.1 General Description).

Cooling fan

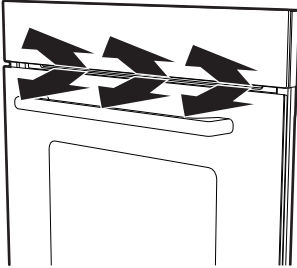

The fan cools the appliance and comes into operation during cooking.

The fan causes a steady outflow of air from above the door which may continue for a brief period of time even after the appliance has been turned off.

2.4 Available accessories



Some models are not provided with all accessories.

Rack

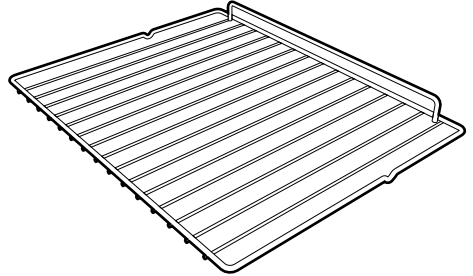

Useful for supporting containers with food during cooking.

Tray rack (on some models only)

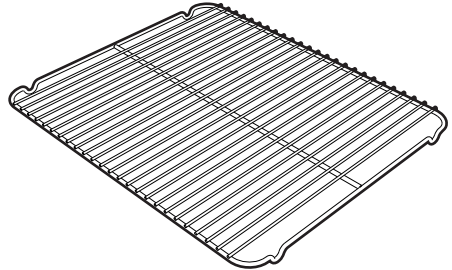

To be placed over the top of the oven tray; for cooking foods which may drip.



Description

Deep tray

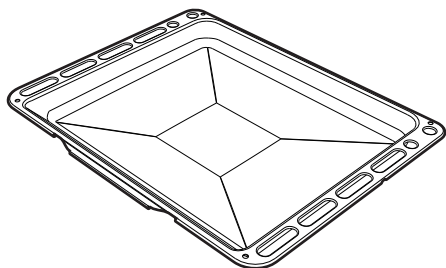

Useful for collecting fat from foods placed on the rack above and for cooking pies, pizzas and baked desserts.

Pizza plate (on some models only)

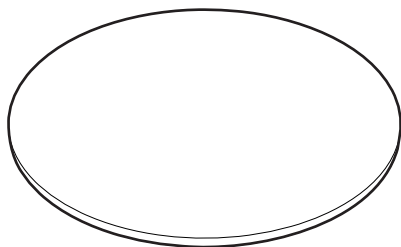

Specially designed for cooking pizza and similar dishes.

Pizza spatula (on some models only)

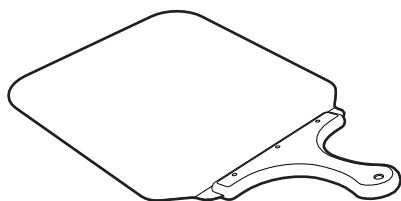

For easily placing the pizza on the pizza plate.

Pizza plate cover (on some models only)

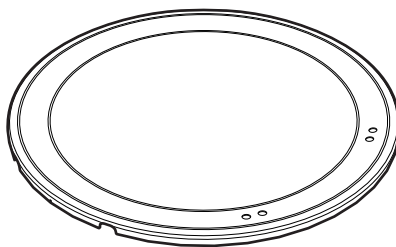

To be placed in the housing on the base of the oven in place of the pizza plate when this is not being used.

Self-cleaning panels (on some models only)

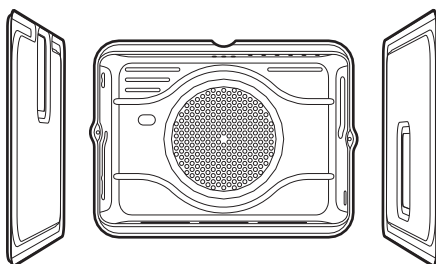

Useful for absorbing small grease residues.

i

The appliance accessories intended to come into contact with food are made of materials that comply with the provisions of current legislation.

i

Supplied original and optional accessories can be requested to Authorised Assistance Centres. Use only original accessories supplied by the manufacturer.



3 Use

3.1 Instructions



High temperature inside the oven during use
Danger of burns

- Keep the oven door closed during cooking.
- Protect your hands by wearing oven gloves when moving food inside the oven.
- Do not touch the heating elements inside the oven.
- Do not pour water directly onto very hot trays.
- Do not allow children to approach the appliance when it is in operation.



High temperature inside the oven during use
Danger of fire or explosion

- Do not spray any spray products near the appliance.
- Do not use or leave flammable materials near the appliance.
- Do not use plastic kitchenware or containers when cooking food.
- Do not put sealed tins or containers in the oven.
- Do not leave the appliance unattended during cooking operations where fats or oils could be released.
- Remove all trays and racks which are not required during cooking.



Improper use

Risk of damage to enamelled surfaces

- Do not cover the bottom of the oven cavity with aluminium or tin foil sheets.
- If you wish to use greaseproof paper, place it so that it will not interfere with the hot air circulation inside the oven.
- Do not place pans or trays directly on the bottom of the oven cavity.
- Do not pour water directly onto very hot trays.

3.2 First use

1. Remove any protective film from the outside or inside of the appliance, including accessories.
2. Remove any labels (apart from the technical data plate) from the accessories and from the oven cavity.
3. Remove and wash all the appliance accessories (see 4 Cleaning and maintenance).
4. Heat the empty oven at the maximum temperature to burn off any residues left by the manufacturing process.



3.3 Using the accessories

Racks and trays

Racks and trays have to be inserted into the side guides until they come to a complete stop.

- The mechanical safety locks that prevent the rack from being taken out accidentally have to face downwards and towards the oven back.

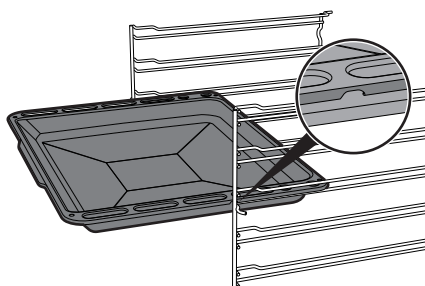
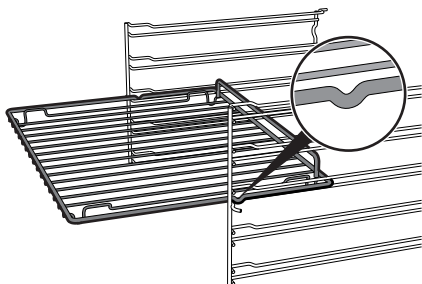

Tray rack (on some models only)

The tray rack has to be inserted into the tray. In this way fat can be collected separately from the food which is being cooked.

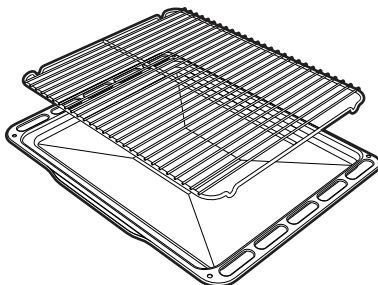

Pizza plate cover and pizza plate (on some models only)



Improper use

Danger of burns and damage to surfaces

- The plate stays hot for many minutes after cooking has ended. Ensure it is handled with due caution.
- Do not use the pizza plate other than as described, for example do not use it on gas or glass ceramic hobs or in ovens which are not designed for this purpose.
- If you like oil on your pizza, it is best to add it after removal from the oven since oil stains on the pizza plate are unsightly and may reduce its efficiency.
- If the pizza plate is not in use, remove it from the oven and cover the bottom of the oven with the cover provided.



Gently insert racks and trays into the oven until they come to a stop.



Clean the trays before using them for the first time to remove any residues left by the manufacturing process.



With the appliance cold, remove the cover from the bottom and insert the pizza plate. Make sure that the plate is inserted correctly in the recess provided.

For cooking use the special pizza function

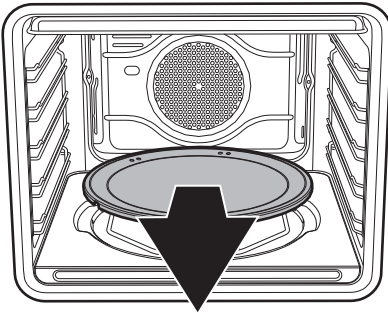

Pizza spatula (on some models only)

Always grip the pizza spatula by the handle when moving food to avoid the risk of burns. You are advised to dust the steel surface lightly with flour to make it easier to slide fresh products on and off, as they could stick to the steel due to their moisture content.

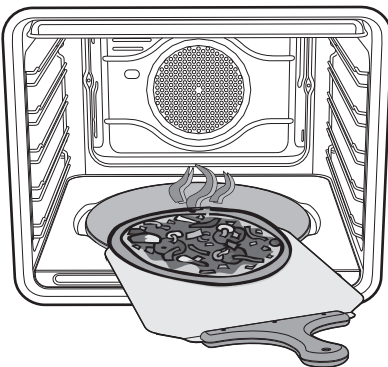

3.4 Using the oven

Switching on the oven

1. Press the function knob to turn on the display.
2. Turn the function knob to the right or left to select the required function.
3. Press the programming knob.
4. Turn the knob to set the temperature.
5. Press the programming knob or wait 3 seconds.
6. Press the function knob to start cooking.



Press and hold the function knob down for around 3 seconds to immediately terminate any cooking operation.

Preheating stage

Cooking itself is preceded by a preheating stage, which allows the appliance to heat to the cooking temperature more quickly.

The **°C** light flashes to indicate that this stage is in progress.

When the preheating stage is over, the **°C** light will remain lit steadily and a buzzer will sound to indicate that the food can be placed inside the oven.



Cooking can be interrupted at any time by pressing and holding the function knob down for at least 3 seconds.



List of cooking functions



Eco (on some models only)

The combination of the grill and the lower heating element, in ECO mode, is particularly indicated for cooking on a single shelf, with reduced power consumption.



Eco (on some models only)

The combination of the fan and the circulaire heating element, in ECO mode, is particularly indicated for cooking on a single shelf, with reduced power consumption.



Static

As the heat comes from above and below at the same time, this system is particularly suitable for certain types of food. Traditional cooking, also known as static cooking, is suitable for cooking just one dish at a time. Perfect for all types of roasts, bread and cakes and in any case particularly suitable for fatty meats such as goose and duck.



Grill

The heat coming from the grill element gives perfect grilling results above all for thin and medium thickness meat and, in combination with the rotisserie (where fitted), gives the food an even browning at the end of cooking. Perfect for sausages, spare ribs and bacon. This function enables large quantities of food, particularly meat, to be grilled evenly.



Lower element (on some models only)

The heat coming just from the bottom allows you to complete the cooking of foods that require a higher bottom temperature, without affecting their browning. Perfect for cakes, pies, tarts and pizzas.



Fan assisted

The operation of the fan, combined with traditional cooking, ensures consistent cooking even with complex recipes. Perfect for biscuits and cakes, even when simultaneously cooked on several levels. (For multiple-level cooking, we recommend using the 2nd and 4th shelves).



Fan with grill

The air produced by the fan softens the strong heatwave generated by the grill, grilling perfectly even very thick foods. Perfect for large cuts of meat (e.g. shin of pork).



Fan + lower element (on some models only)

The combination of the fan with just the lower heating element allows cooking to be completed more rapidly. This system is recommended for sterilising or for finishing off the cooking of foods which are already well-cooked on the surface, but not inside, which therefore need a little more heat. Perfect for any type of food.

In pyrolytic models, the special defrost and proving functions are brought together under the same function.



Turbo (on some models only)

The combination of fan assisted cooking and traditional cooking allows different foods to be cooked on several levels extremely quickly and efficiently, without odours and flavours mingling. Perfect for large volumes that call for intense cooking. (For multiple-level cooking, we recommend using the 1st and 4th shelves).



Circulaire (on some models only)

The combination of the fan and the circulaire heating element (incorporated in the rear of the oven) allows you to cook different foods on several levels, as long as they need the same temperatures and type of cooking. Hot air circulation ensures instant and even distribution of heat. It will be possible, for instance, to cook fish, vegetables and biscuits simultaneously (on different levels) without odours and flavours mingling.



Pizza (on some models only)







The operation of the fan, combined with the grill and the lower heating element, ensures uniform cooking even with complex recipes. Perfect not just for pizzas, but also for biscuits and cakes.







Use

Display



-  Clock indicator light
-  Minute minder timer indicator light
-  Programmed cooking indicator light
-  Timed cooking indicator light
-  Door lock indicator light (pyrolytic models only)
-  Child lock indicator light
-  Showroom indicator light

Each time the programming knob is pressed during a function, the parameters will be cycled through in the following order.

-  Temperature
-  Minute minder timer duration
-  Programmed cooking duration
-  Timed cooking duration
-  Current time display

In all states it is possible to modify the value by turning the programming knob to the left or right. Keep the knob turned to produce a faster increase or decrease.

Operating modes

Stand-by: When no function is selected, the display shows the current time.



ON: When a function is activated, the display shows the parameters set such as temperature, duration and temperature reached.





Setting the time

On the first use, or after a power failure, the message **00:00** will flash on the appliance's display. To be able to start any cooking function, the current time must be set.

1. Turn the programming knob to set the displayed hour (keep the knob turned to produce a faster increase or decrease).
2. Press the programming knob.
3. Turn the programming knob to set the minutes (keep the knob turned to produce a faster increase or decrease).
4. Press the programming knob to complete the setting.



It may become necessary to change the current time, for example for daylight saving time. From the stand-by position, keep the programming knob turned to the right or left until the hours flash. It is not possible to change the time if the oven is **ON**.

Minute minder





This function only activates the buzzer, without stopping cooking.



The minute minder can be activated both during cooking and when the appliance is in standby.

1. Press the programming knob once (twice if cooking is already in progress). The display shows **00:00** and the  indicator light flashes.



2. Turn the programming knob to set the duration (from 1 minute to 4 hours). After a few seconds, the  indicator light stops flashing and the countdown starts.
3. Wait for the buzzer to indicate that the time has finished. The  indicator light flashes.
4. Turn the programming knob to select another minute minder. Or else press the programming knob to stop the buzzer.



Use

Timed cooking

i Timed cooking is the function which allows a cooking operation to be started and then ended after a specific length of time set by the user.

i Activation of timed cooking cancels any minute minder timer which may previously have been set.

1. After selecting a cooking function and temperature, press the programming knob three times. The display shows **00:00** and the  indicator light flashes.



2. Turn the programming knob to set the cooking time (from 00:01 to 13:00). Keep the knob turned to produce a faster increase or decrease.





3. A few seconds after the required duration is set, the  indicator light stops flashing. Press the function knob to start timed cooking.

4. At the end of the cooking time STOP flashes on the display and a buzzer will sound that can be deactivated by pressing the function knob.



 To select a further timed cooking, turn the programming knob right or left again.

 To extend the cooking time manually, press the programming knob again. The appliance resumes its normal operation with the previously selected cooking settings.

 Press and hold the function knob down to switch off the appliance.



Programmed cooking

i Programmed cooking is the function which allows a cooking operation to be stopped automatically at an established time depending on the time set by the user, after which the oven will switch off automatically.



1. After selecting a cooking function and temperature, press the programming knob three times. The display shows  and the  indicator light flashes.



2. Turn the knob to set the cooking time (from 00:01 to 13:00). Keep the knob turned for a fast increase or decrease.



3. Press the programming knob a fourth time. The  indicator light flashes. Turn the knob to set the cooking end time.

4. After a few seconds the  and  indicator lights stop flashing. The appliance waits for the set start time.



5. At the end of the cooking time STOP flashes on the display and a buzzer will sound that can be deactivated by pressing the function knob.



 To extend the cooking time manually, press the programming knob again. The appliance resumes its normal operation with the previously selected cooking settings.

 Press and hold the function knob down to switch off the appliance.

i For safety reasons, it is not possible to set the end of cooking time by itself without setting the cooking duration.



3.5 Cooking advice

General advice

- Use a fan assisted function to achieve consistent cooking at several levels.
- It is not possible to shorten cooking times by increasing the temperature (the food could be overcooked on the outside and undercooked on the inside).

Advice for cooking meat

- Cooking times vary according to the thickness and quality of the food and to consumer taste.
- Use a meat thermometer when roasting meat, or simply press on the roast with a spoon. If it is hard, it is ready; If not, it needs another few minutes cooking.

Advice for cooking with the Grill and the Fan with grill

- Meat can be grilled even when it is put into the cold oven or into the preheated oven if you wish to change the effect of the cooking.
- With the Fan with grill function, we recommend that you preheat the oven before grilling.
- We recommend placing the food at the centre of the rack.
- With the Grill function, we recommend that you set the temperature to the maximum value to optimise cooking.

Advice for cooking desserts/ pastries and biscuits

- Use dark metal moulds: They help to absorb the heat better.
- The temperature and the cooking time depend on the quality and consistency of the dough.

- To check whether the dessert is cooked right through: At the end of the cooking time, put a toothpick into the highest point of the dessert. If the dough does not stick to the toothpick, the dessert is cooked.
- If the dessert collapses when it comes out of the oven, on the next occasion reduce the set temperature by about 10°C, selecting a longer cooking time if necessary.

Advice for defrosting and proving

- Place frozen foods without their packaging in a lidless container on the first shelf of the oven.
- Avoid overlapping the food.
- To defrost meat, use the rack placed on the second level and a tray on the first level. In this way, the liquid from the defrosting food drains away from the food.
- The most delicate parts can be covered with aluminium foil.
- For successful proving, a container of water should be placed in the bottom of the oven.

To save energy

- Stop cooking a few minutes before the time normally used. Cooking will continue for the remaining minutes with the heat which has accumulated inside the oven.
- Reduce any opening of the door to a minimum to avoid heat dispersal.
- Keep the inside of the appliance clean at all times.
- (Where fitted) When it is not being used, remove the pizza plate and put the cover back in its slot.



Cooking information table

Food	Weight (Kg)	Function	Runner position from the bottom	Temperature (°C)	Time (minutes)	
Lasagne	3 - 4	Static	1	220 - 230	45 - 50	
Pasta bake	3 - 4	Static	1	220 - 230	45 - 50	
Roast veal	2	Turbo/Fan assisted	2	180 - 190	90 - 100	
Pork	2	Turbo/Fan assisted	2	180 - 190	70 - 80	
Sausages	1.5	Fan with grill	4	280	15	
Roast beef	1	Turbo/Fan assisted	2	200	40 - 45	
Roast rabbit	1.5	Circulaire/Fan assisted	2	180 - 190	70 - 80	
Turkey breast	3	Turbo/Fan assisted	2	180 - 190	110 - 120	
Roast pork neck	2 - 3	Turbo/Fan assisted	2	180 - 190	170 - 180	
Roast chicken	1.2	Turbo/Fan assisted	2	180 - 190	65 - 70	
					1st surface	2nd surface
Pork chops	1.5	Fan with grill	4	280	15	5
Spare ribs	1.5	Fan with grill	4	280	10	10
Bacon	0.7	Grill	5	280	7	8
Pork fillet	1.5	Fan with grill	4	280	10	5
Beef fillet	1	Grill	5	280	10	7
Salmon trout	1.2	Turbo/Fan assisted	2	150 - 160	35 - 40	
Monkfish	1.5	Turbo/Fan assisted	2	160	60 - 65	
Turbot	1.5	Turbo/Fan assisted	2	160	45 - 50	
Pizza	1	Turbo/Fan assisted	2	280	8 - 9	
Bread	1	Circulaire/Fan assisted	2	190 - 200	25 - 30	
Focaccia	1	Turbo/Fan assisted	2	180 - 190	20 - 25	
Bundt cake	1	Circulaire/Fan assisted	2	160	55 - 60	
Jam tart	1	Circulaire/Fan assisted	2	160	35 - 40	
Ricotta cake	1	Circulaire/Fan assisted	2	160 - 170	55 - 60	
Jam tarts	1	Turbo/Fan assisted	2	160	20 - 25	
Paradise cake	1.2	Circulaire/Fan assisted	2	160	55 - 60	
Profiteroles	1.2	Turbo/Fan assisted	2	180	80 - 90	
Sponge cake	1	Circulaire/Fan assisted	2	150 - 160	55 - 60	
Rice pudding	1	Turbo/Fan assisted	2	160	55 - 60	
Brioches	0.6	Circulaire/Fan assisted	2	160	30 - 35	

The times indicated in the table do not include preheating times and are provided only as a guide.



3.6 Special functions

Defrost by time



This function allows you to defrost food on the basis of a selectable time.

1. Place the food inside the oven.
2. Press and turn the function knob to select the defrost by time function marked by the ❄️ indicator light and the 🍳 indicator light flashing.



3. Turn the programming knob to adjust the duration (from 1 minute to 13 hours).
4. Press the programming knob to confirm the values entered.
5. Press the function knob to start defrosting.
6. At the end of the defrost time STOP flashes on the display and a buzzer will sound that can be deactivated by pressing the function knob.



Defrost by weight



This function defrosts foods on the basis of the type and weight of the frozen product.

1. Place the food inside the oven.
2. Press and turn the function knob to select the defrost by weight function, marked by the ❄️ indicator light and **d00**.



3. Press the function knob to confirm.
4. Turn the function knob to select the type of food to defrost.
5. Press and turn the programming knob to select the weight (in grams) of the food to defrost.
6. Press the function knob to confirm the parameters and start defrosting.



- At the end of the defrost time STOP flashes on the display and a buzzer will sound that can be deactivated by pressing the function knob.



Preset parameters:



dE	Type	Weight (g)	Time (min)
d01	Meat	500	105
d02	Fish	400	40
d03	Fruit	300	45
d04	Bread	300	20

Proving

i For successful proving, a container of water should be placed in the bottom of the oven.

- Press and turn the function knob to select the proving function.



- Press the function knob to start the proving function.
- While the function is in progress, it is possible to set a minute minder  (see "Minute minder"), a proving duration  (see "Timed cooking") or delayed proving  (see "Programmed cooking"). Press the programming knob to make the desired changes.

i Unless otherwise set, the proving will have a maximum duration of 13 hours.

i The light inside the oven will remain off during the proving function.

- When the proving function finishes a buzzer will sound; to stop the buzzer, press the function knob.

 It is not possible to modify the temperature of the proving function.

EN



Use

Sabbath



The appliance follows some specific behaviour when operating in this function:

- Cooking can proceed indefinitely, it is not possible to set any cooking duration.
- No preheating will be performed.
- The cooking temperature which can be selected varies between 60-100 °C.
- Oven light disabled, any operation such as opening the door (where present) or manual activation with the knob will not activate the light.
- Oven fan disabled.
- Knob lights and buzzers disabled.



After activating the Sabbath function it will no longer be possible to modify any parameters.

Any action on the knobs will produce no effect; only the function knob remains active to allow you to return to the main menu.

1. Press and turn the function knob to select the Sabbath function.



2. Press and turn the programming knob to select the required temperature (from 60°C to 100°C).



3. Press the programming knob to confirm the parameters entered.
4. Press the function knob to start the Sabbath function.
5. To exit this function, press and hold the function knob down for at least 5 seconds.



3.7 Secondary menu

The appliance also has a drop-down secondary menu allowing the user to:

- Activate or deactivate the Child Lock.
- Activate or deactivate Showroom mode (which disables all the heating elements so that only the control panel works).
- Activate or deactivate Eco-Logic mode.
- Activate or deactivate Eco light mode.

With the appliance in stand-by status

1. Turn the programming knob to the right to activate the oven light.
2. Press and hold the programming knob down for at least 5 seconds.
3. Turn the programming knob right or left to change the setting status (ON/OFF).
4. Press the programming knob to move to the next mode.

Child Lock mode: This mode allows the appliance to lock the controls automatically after one minute of normal operation without any intervention from the user.



During normal operation it is indicated by the  indicator light coming on.

To temporarily release the lock during cooking, hold the programming knob down for 5 seconds. One minute after the last setting the lock will become active again.



Touching or varying the position of the temperature and function knobs, the display will show **bLoC** for two seconds.



It is still possible to turn the appliance off instantaneously by pressing and holding the function knob down for 3 seconds when in child lock mode.



Use

Showroom mode (for exhibitors only):

This mode allows the appliance to deactivate all heating elements, while keeping the control panel active.



To use the appliance normally, set this mode to **OFF**.

Eco-logic mode: This mode allows the appliance to limit the power used.

Indicated for use of multiple appliances at the same time on circuits with limited maximum power.



HI: normal power.

LO: low power.



Activating eco-logic mode means that preheating and cooking times may be extended.



If the mode is active, the  indicator light lights up on the display.



Keep warm

This mode allows the appliance to keep cooked food warm (at low temperatures) after cooking finishes with a cooking cycle for which a duration has been set (if this is not manually interrupted), without altering the taste and aromas obtained during cooking.



To use the appliance normally, set this mode to **OFF**.

Eco-light mode

For greater energy savings, the light is automatically deactivated one minute from the start of cooking.



To stop the appliance from automatically deactivating the light after one minute, set this mode to **OFF**.



The manual on/off control is always available with both settings by turning the programming knob to the right.



Cleaning and maintenance

4 Cleaning and maintenance

4.1 Instructions



Improper use
Risk of damage to surfaces

- Do not use steam jets to clean the appliance.
- Do not use detergents which are abrasive, corrosive or which contain chlorine, ammonia or bleach (e.g. scouring powders, stain removers, etc.).
- Do not use rough or abrasive materials or sharp metal scrapers.

4.2 Cleaning the appliance



We recommend the use of cleaning products distributed by the manufacturer.

Recommendations for cleaning the oven compartment

In order to keep your oven in the best possible condition, clean it regularly after letting it cool down.

Avoid letting food residue dry inside the oven compartment, as this could damage the enamel.

Take out all removable parts before cleaning.

For easier cleaning, we recommend removing:

- The door
- The rack/tray support frames
- The oven seal (pyrolytic models excluded)



In the event you are using specific cleaning products, we recommend running the oven at maximum temperature for 15-20 minutes in order to eliminate any residue.

4.3 Removing the door

For easier cleaning, the door can be removed and placed on a canvas.

To remove the door proceed as follows:

1. Open the door completely and insert two pins into the holes on the hinges indicated in the figure.

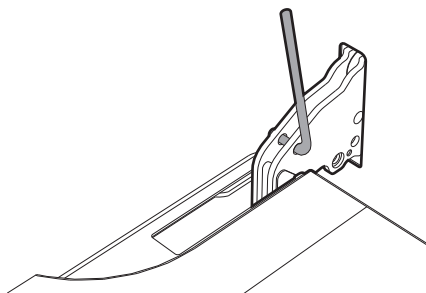

2. Grasp the door on both sides with both hands, lift it forming an angle of around 30° and remove it.

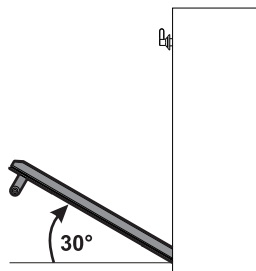



3. To reassemble the door, put the hinges in the relevant slots in the oven, making sure that grooved sections **A** are resting completely in the slots. Lower the door and once it is in place remove the pins from the holes in the hinges.

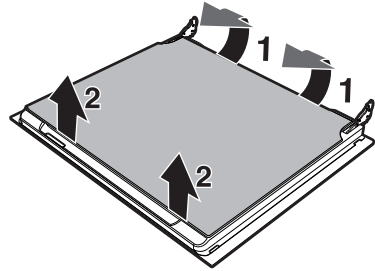
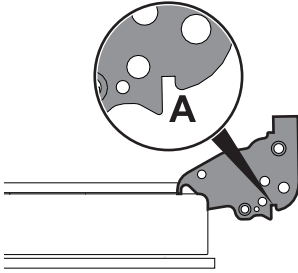

3. Some models have an intermediate glass pane. Remove the intermediate glass pane by lifting it upwards.

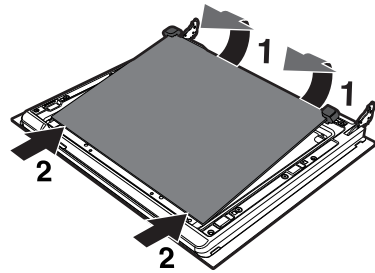

4.4 Cleaning the door glazing

The glass in the door should always be kept thoroughly clean. Use absorbent kitchen roll. In case of stubborn dirt, wash with a damp sponge and an ordinary detergent.

Removing the internal glass panes

For easier cleaning the door internal glass panes can be disassembled.

1. Remove the internal glass pane by pulling the rear part gently upwards, following the movement indicated by the arrows (**1**).
2. Then, pull the front part upwards (**2**). In this way, the 4 pins attached to the glass detach from their housings in the oven door.

4. Clean the external glass pane and the panes previously removed. Use absorbent kitchen roll. In case of stubborn dirt, wash with a damp sponge and neutral detergent.

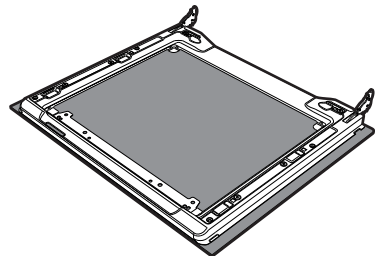



Cleaning and maintenance

5. Refit the panes in the reverse order in which they were removed.
6. Reposition the internal glass pane. Take care to centre and insert the 4 pins into their housings in the oven door by applying slight pressure.

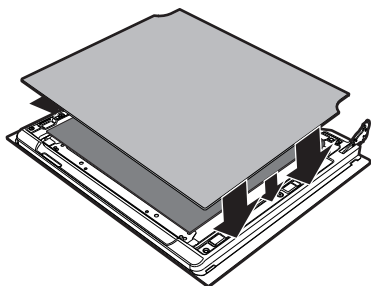

Removing rack/tray support frames

Removing the rack/tray support frames enables the sides to be cleaned more easily. This operation should be performed each time the automatic cleaning cycle is used (on some models only).

To remove the rack/tray support frames:

1. Pull the frame towards the inside of the oven to unhook it from its groove **A**.
2. Then slide it out of the seats at the back **B**.
3. When cleaning is complete, repeat the above procedures to put the rack/tray support frames back in.

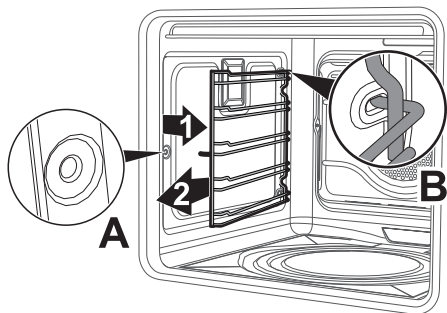

Removing self-cleaning panels and rack/tray support frames (fitted only to some models)

Removing the self-cleaning panels and the rack/tray support frames enables the sides to be cleaned more easily.

To remove the rack/tray support frames:

1. Pull the frame towards the inside of the oven to unhook it from its groove **A**.
2. Then slide it out of the seats at the back **B**.
3. When cleaning is complete, repeat the above procedures to put the rack/tray support frames back in.

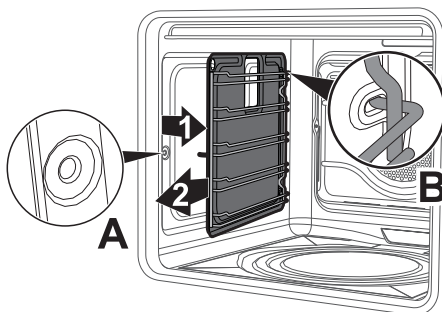



Regeneration of self-cleaning panels (catalysis cycle) (on some models only)

The regeneration cycle of the self-cleaning panels is a cleaning method through heating suitable for removing small grease residues, not sugar-based ones.

1. Clean the base and the upper guard first (where fitted) with a microfibre cloth soaked in water and neutral washing up liquid. Rinse thoroughly.
2. Set a regeneration cycle by selecting a fan assisted function at the maximum temperature for one hour.
3. If the panels are particularly dirty after the regeneration cycle, remove them and wash them with neutral washing up liquid. Rinse and dry them.
4. Put the panels back in the oven and set a fan assisted function at a temperature of 180°C for one hour, in order to ensure that they are thoroughly dry.



We recommend carrying out the self-cleaning panel regeneration cycle every 15 days.

On pizza models only:

Remove in sequence the pizza plate cover (1) and the base (2) on which it is placed. The base has to be lifted a few millimetres, then pulled outwards.

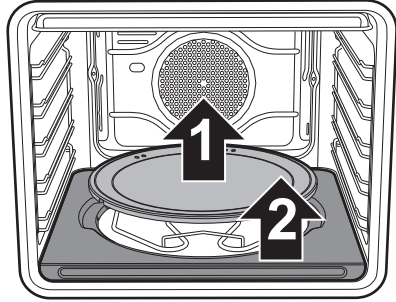

Lift the end of the lower heating element (3) a few centimetres and clean the oven base.

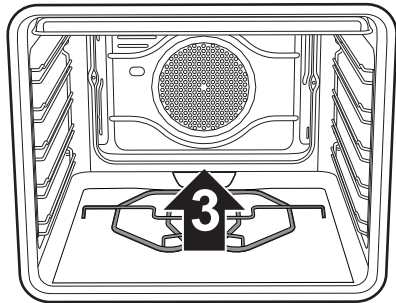

Put the pizza plate base back in place, pushing it in until it hits the back of the oven, and push it down so that the heating element plate is embedded into the base itself.



Cleaning and maintenance

4.5 Vapor Clean (on some models only)



Vapor Clean is an assisted cleaning procedure which facilitates the removal of dirt. Thanks to this process, it is possible to clean the inside of the oven very easily. The dirt residues are softened by the heat and water vapour for easier removal afterwards.



Improper use Risk of damage to surfaces

- Remove any food residues or large spills from previous cooking operations from the inside of the oven.
- Carry out assisted oven cleaning operations only when the oven is cold.

Preliminary operations

Before starting the Vapor Clean function:

- **For Multifunction models:** Completely remove all accessories from inside the oven. The upper guard (where fitted) can be left inside the oven.
- Remove the self-cleaning panels (where fitted) "Removing self-cleaning panels and rack/tray support frames (fitted only to some models)".
- Pour approx. 40 cc of water onto the floor of the oven. Make sure it does not overflow out of the cavity.

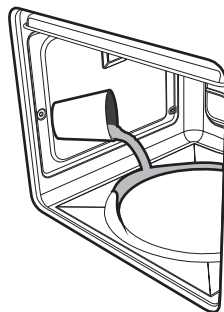

- **For models with Pizza plate:** Remove all accessories from the inside of the oven, except the rack/tray support frames. The upper guard (where fitted) can be left inside the oven.



The cover should be placed in the housing on the base of the oven in place of the pizza plate.

- Place a tray on the first shelf.
- Pour approximately 40 cc of water into the tray. Make sure it does not overflow out of the tray.

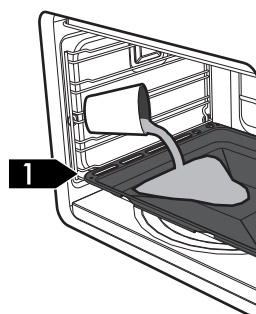



- **For Multifunction models and models with Pizza plate:** Spray a water and washing up liquid solution inside the oven using a spray nozzle. Direct the spray against the side walls, upwards, downwards and towards the deflector.

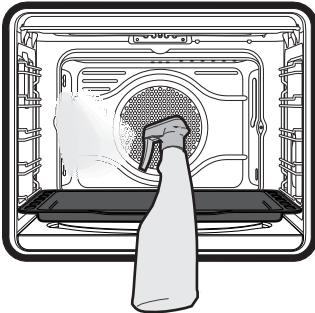
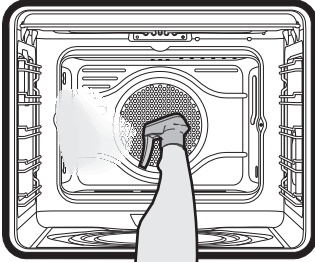

We recommend spraying approx. 20 times at the most.

- Close the door.
- During the assisted cleaning cycle, wash the self-cleaning panels (where fitted) which were previously removed separately in warm water and a small amount of detergent.

Vapor Clean setting

i

If the internal temperature is greater than that required for the Vapor clean function, the cycle will be stopped immediately,

Stop will appear on the display and a buzzer will sound. Let the appliance cool down before activating Vapor Clean.

1. Press and turn the function knob to select the Vapor Clean function.



2. The duration of the Vapor Clean cycle will appear on the display.

i

The duration and temperature parameters cannot be modified by the user.

3. Press the function knob to start Vapor Clean.









Cleaning and maintenance

- At the end of the Vapor Clean cycle, STOP flashes on the display and a buzzer will sound that can be deactivated by pressing the function knob.



Setting timed Vapor Clean

It is possible to program the Vapor Clean start time, like any cooking function.

- After selecting the Vapor Clean function, press the programming knob. The display will show the current time and the temperature, and the  indicator light will come on.
- Turn the programming knob to set the time you wish Vapor Clean to finish.
- Press the programming knob to confirm the values entered. The ,  and  indicator lights turn on steadily and the appliance then waits for the set start time to begin the Vapor Clean cycle.

End of Vapor Clean

- Open the door and wipe away the less stubborn dirt with a microfibre cloth.
- Use an anti-scratch sponge with brass filaments on tougher encrustations.
- In case of grease residues use specific oven cleaning products.
- Remove the residual water inside the oven.
- Where fitted, reposition the self-cleaning panels and the rack/tray support frames.

For greater hygiene and to avoid foods taking on unpleasant odours:

- We recommend drying the inside of the oven with a fan assisted function at 160°C for around 10 minutes.
- Where the self-cleaning panels are fitted, we recommend drying the inside of the oven with a simultaneous catalysis cycle "Regeneration of self-cleaning panels (catalysis cycle) (on some models only)".



We recommend wearing rubber gloves for these operations.



For easier manual cleaning of the parts difficult to reach, we recommend removing the door.



4.6 Pyrolytic function (on some models only)



Pyrolytic cleaning is an automatic high-temperature cleaning procedure which causes dirt to dissolve. Thanks to this process, it is possible to clean the inside of the oven very easily.



Improper use Risk of damage to surfaces

- Remove any food residues or large spills from previous cooking operations from the inside of the oven.
- Switch off the burners or electric hot plates of the hob installed above the oven.

Preliminary operations

Before starting the pyrolytic cycle:

- Clean the internal glass pane following the usual cleaning instructions.
- For very stubborn encrustations spray an oven cleaning product onto the glass (read the warnings on the product); leave for 60 minutes, then rinse and dry the glass using kitchen roll or a microfibre cloth.
- Completely remove all accessories from inside the oven.
- Remove the rack/tray support frames.
- Remove the upper guard (when fitted).
- Close the door.

Pyrolytic function setting

1. Press and turn the function knob to select the Eco Pyrolytic or Pyrolytic function.



2. The duration of the Pyrolytic cycle will appear on the display.
3. Press and turn the programming knob to set the Pyrolytic cycle duration from a minimum of 2 hours to a maximum of 3 hours (except for the **PECO** function whose duration is 2 hours).
4. Press the programming knob to confirm the values entered.
5. Press the function knob to start the Pyrolytic cycle.



Recommended pyrolytic cycle duration:

- Light dirt: 2 hours.
- Medium dirt: 2 ½ hours.
- Heavy dirt: 3 hours.



Cleaning and maintenance

Pyrolytic cycle

1. Two minutes after the Pyrolytic cycle starts, the  indicator light comes on to indicate that the door is locked by a device that prevents the door from being opened.

 It is not possible to select any function once the door lock device has been activated.

2. At the end of the Pyrolytic cycle, STOP flashes on the display and a buzzer will sound that can be deactivated by pressing the function knob.



3. The door remains locked as long as the temperature inside the oven returns to safety levels. Wait for the oven to cool down (the  indicator light will turn off) and collect the residue deposited inside the oven with a damp microfibre cloth.

 During the first Pyrolytic cycle, unpleasant odours may occur due to the normal evaporation of oily manufacturing substances. This is an absolutely normal phenomenon which disappears after the first pyrolytic cycle.





 During the pyrolytic cycle the fans produce a more intense level of noise due to a greater rotation speed. This is an absolutely normal operation, intended to provide more effective heat dispersal. At the end of the pyrolytic cycle, the fans will continue to operate for long enough to avoid overheating the walls of adjacent units and the front of the oven.

 If the pyrolytic cycle gives unsatisfactory results at minimum duration, it is recommended to set a longer time for subsequent cleaning cycles.



Setting of a programmed Pyrolytic cycle

It is possible to program the pyrolytic cycle start time like all other cooking functions.

1. After selecting the Pyrolytic function and setting the duration (except for Eco Pyrolytic), press the programming knob. The display will show the current time and the temperature, and the  indicator light will come on.
2. Turn the programming knob to set the time you wish the Pyrolytic cycle to finish.
3. Press the programming knob to confirm the values entered. The ,  and  indicator lights turn on steadily and the appliance then waits for the set start time to begin the Pyrolytic cycle.



It is not possible to select any function once the door lock device has been activated. It remains possible, however, to switch off the appliance using the specific controls.

4.7 Extraordinary maintenance



Live parts
Danger of electrocution

- Disconnect the appliance from the power supply.

Replacing the internal light bulb

1. Completely remove all accessories from inside the oven.
2. Remove the rack/tray support frames.
3. Remove the bulb cover using a tool (e.g. a screwdriver).



Pay attention not to scratch the oven compartment enamel.

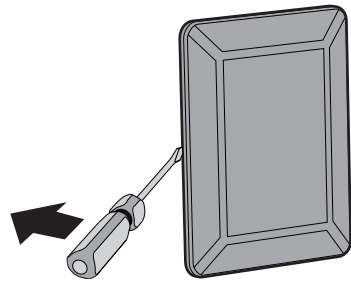



Cleaning and maintenance

- Slide out and remove the lamp.

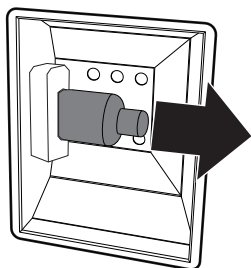

Do not touch the halogen lamp directly with your fingers, but wrap it in insulating material.

- Replace the lamp with one of the same type (40W).
- Refit the cover. Ensure the moulded part of the glass **(A)** is facing the door.

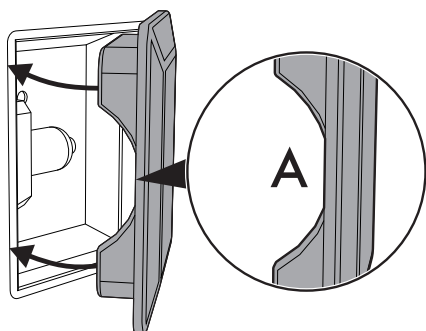

- Press the cover completely down so that it attaches perfectly to the bulb support.

Removing and fitting the oven seal (pyrolytic models excluded)

To remove the oven seal:

- Unhook the clips in the 4 corners then pull the oven seal outwards.

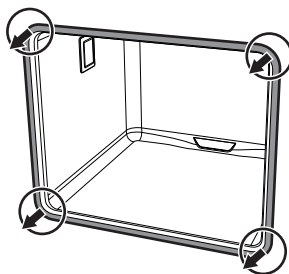

To install the oven seal:

- Hook the clips in the 4 corners onto the oven seal.

Oven seal maintenance tips

The seal should be soft and elastic.

- To keep the oven seal clean, use a non-abrasive sponge and lukewarm water to wash it.



5 Installation

5.1 Electrical connection



Power voltage
Danger of electrocution

- Have the electrical connection performed by authorised technical personnel.
- The appliance must be connected to earth in compliance with electrical system safety standards.
- Disconnect the main power supply.

General information

Check the grid characteristics against the data indicated on the plate.
The identification plate bearing the technical data, serial number and brand name is visibly positioned on the appliance.
Do not remove this plate for any reason.
The appliance works at 220-240 V~.
Use an H05V2V2-F type three-core cable (3 x 1.5 mm² cable, referring to the cross section of the internal conductor).
Perform the earth/ground connection using a wire that is 20 mm longer than the other wires.

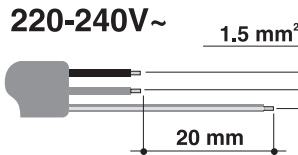

Fixed connection

Fit the power line with an omnipolar circuit breaker in compliance with installation regulations.

The circuit breaker should be located near the appliance and in an easily reachable position.

Connection with plug and socket

Make sure that the plug and socket are of the same type.

Avoid using adapters and shunts as these could cause overheating and a risk of burns.

5.2 Cable replacement



Power voltage
Danger of electrocution

- Disconnect the main power supply.

1. Unscrew the rear casing screws and remove the casing to access the terminal board.

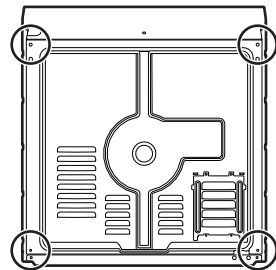

2. Replace the cable.
3. Make sure that the cables (for the oven or any hob) follow the best route in order to avoid any contact with the appliance.



Installation

5.3 Positioning



Heavy appliance
Crushing hazard

- Position the appliance into the cabinet cutout with the help of a second person.



Pressure on the open door
Risk of damage to the appliance

- Never use the oven door to lever the appliance into place when fitting.
- Avoid exerting too much pressure on the oven door when open.



Heat production during appliance operation
Risk of fire

- Check that the piece of furniture material is heat resistant.
- Check that the piece of furniture has the required slots.

Fastening bushings

1. Remove the bushing covers inserted on the front of the appliance.

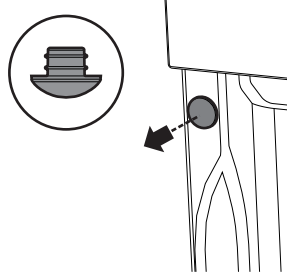

2. Mount the appliance into the recess.
3. Secure the appliance to the piece of furniture using screws.

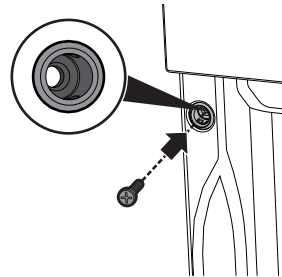

4. Cover the bushings with the covers removed previously.

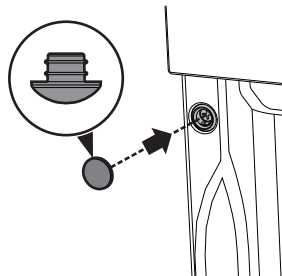

Installation



Appliance overall dimensions (mm)

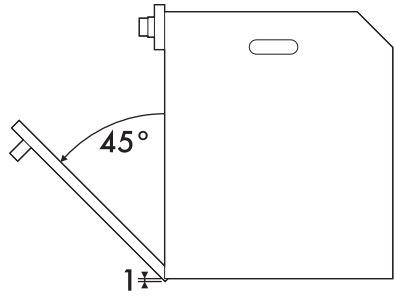
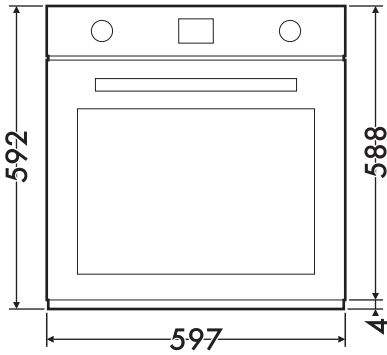

EN

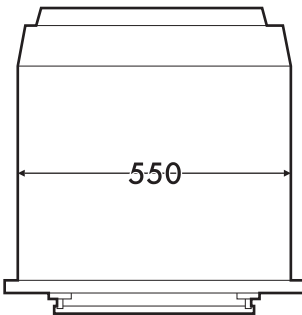
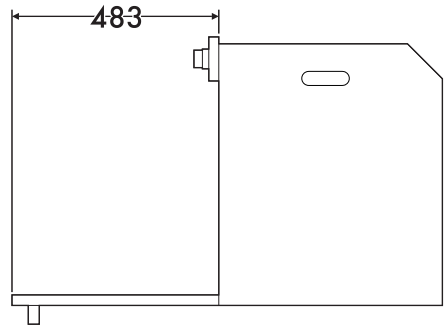
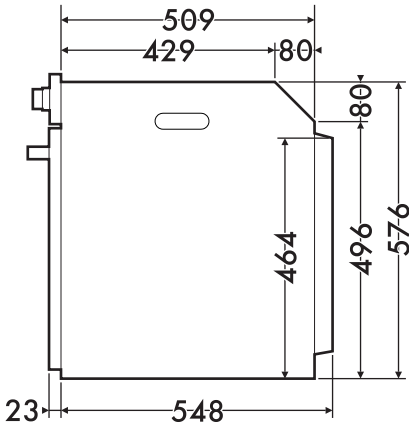



Installation

Mounting under worktops (mm)

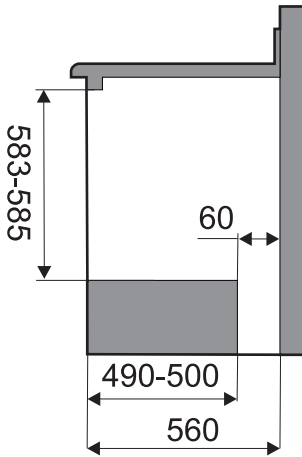
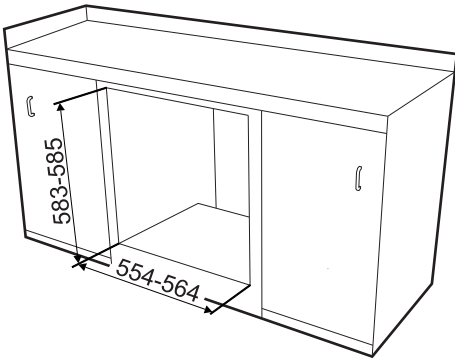

Mounting into a column (mm)

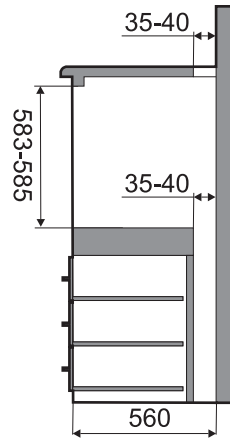
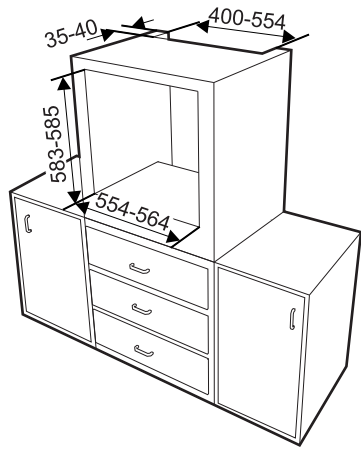

Make sure that the piece of furniture rear/bottom part has an opening of approx. 60 mm.



Make sure that the piece of furniture top/rear part has an opening approx. 35-40 mm deep.