

DN-2

Dyna Drive

Owner's Manual

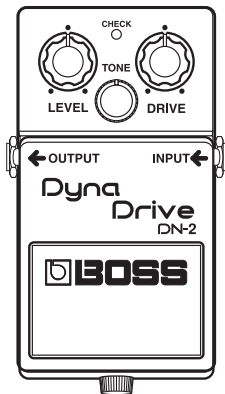

BOSS[®]

Thank you, and congratulations on your choice of the BOSS DN-2 Dyna Drive.

Before using this unit, carefully read the sections entitled: "USING THE UNIT SAFELY" and "IMPORTANT NOTES" (supplied on a separate sheet). These sections provide important information concerning the proper operation of the unit.

Additionally, in order to feel assured that you have gained a good understanding of every feature provided by your new unit, this manual should be read in its entirety. The manual should be saved and kept on hand as a convenient reference.

A battery is supplied with the unit. The life of this battery may be limited, however, since its primary purpose is to enable testing.

Copyright © 2006 BOSS CORPORATION

All rights reserved. No part of this publication may be reproduced in any form without the written permission of BOSS CORPORATION.

Main Features

- The DN-2 is an overdrive that changes the tone in response to the force of picking and the volume control on the guitar.
- Transforms the sound into one where reverberating strings retain their sharpness even if the guitar's volume is turned down.
- By simply turning the DRIVE knob, you get broad-ranging control over the depth of distortion. Whether it be a crunch sound, overdrive with strong attack, or long sustain with a boosted midrange, it's right at your fingertips.

Panel Descriptions

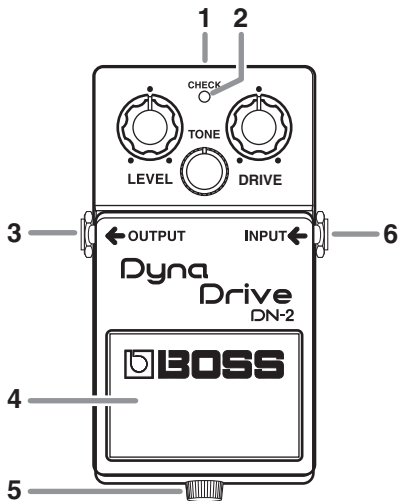

1. AC Adaptor Jack

This jack accepts the connection of an AC adaptor (optionally available BOSS PSA-series). By using an AC adaptor, you can play without being concerned about how much battery power you have left.

- * Use only the specified AC adaptor (PSA-series), and make sure the line voltage at the installation matches the input voltage specified on the AC adaptor's body. Other AC adaptors may use a different polarity, or be designed for a different voltage, so their use could result in damage, malfunction, or electric shock.
- * If the AC adaptor is connected while power is on, the power supply is drawn from the AC adaptor.
- * If there is a battery in the unit while an AC adaptor is being used, the DN-2 will switch over to battery-powered operation should the

line voltage be interrupted due to a power blackout or power cord disconnection.

2. CHECK Indicator

This indicator shows whether the effect is on or off, and also doubles as the battery check indicator. The indicator lights when the effect is on.

- * *If you're powering the unit with a battery and the CHECK indicator goes dim—or doesn't light at all—when you try to turn the effect on, the battery is near depletion and should be replaced. For instructions on changing the battery, refer to “Changing the Battery” (p. 11).*
- * *The CHECK indicator shows whether the effect is being applied or not. It does not indicate whether the power to the device is on or not.*

3. OUTPUT Jack

Connect this jack to the input of a guitar amp or another effects processor.

4. Pedal Switch

This switch turns the effect on/off.

5. Thumbscrew

When this screw is loosened, the pedal will open, allowing you to change the battery.

- * *For instructions on changing the battery, refer to “Changing the Battery” (p. 11).*

6. INPUT Jack

This jack accepts signals coming from a guitar or other musical instrument, or another effects unit.

- * *The INPUT jack doubles as power switch. Power to the unit is turned on when you plug into the INPUT jack; the power is turned off when the cable is unplugged. When not using the effects unit, be sure to disconnect the plug from the INPUT jack.*

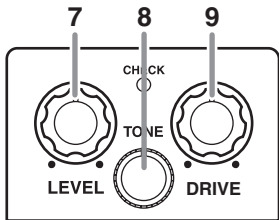

7. LEVEL Knob

This adjusts the volume of the effect sound.

- * *No sound is output when this knob is turned completely counterclockwise.*

8. TONE Knob

This adjusts the tone of the sound. Turning the TONE knob clockwise emphasizes the high-frequency range, resulting in a tone with greater attack; turning it counterclockwise creates a soft tone with reduced treble.

9. DRIVE Knob

This knob controls the amount of overdrive. Tuning the knob clockwise boosts the amount of overdrive applied.

Connections

- * *Inserting a connecting plug into the INPUT jack turns on the power to the unit.*
- * *Raise the amp volume only after turning on the power to all connected devices.*
- * *The use of an AC adaptor is recommended as the unit's power consumption is relatively high. Should you prefer to use a battery, please use the alkaline type.*
- * *To prevent malfunction and/or damage to speakers or other devices, always turn down the volume, and turn off the power on all devices before making any connections.*
- * *If there is a batteries in the unit while an AC adaptor is being used, normal operation will continue should the line voltage be interrupted due to power blackout or power cord disconnection.*
- * *Some connection cables contain resistors. When connection cables with resistors are used, the sound level to be extremely low, or impossible to hear. For*

information on cable specifications, contact the manufacturer of the cable.

- * *Once the connections have been completed, turn on power to your various devices in the order specified. By turning on devices in the wrong order, you risk causing malfunction and/or damage to speakers and other devices.*

When powering up:

Turn on the power to your guitar amp last.

When powering down:

Turn off the power to your guitar amp first.

- * *Always make sure to have the volume level turned down before switching on power. Even with the volume all the way down, you may still hear some sound when the power is switched on, but this is normal, and does not indicate a malfunction.*
- * *When operating on battery power only, the CHECK indicator will become dim when battery power gets too low. Replace the battery as soon as possible.*

A NOTE About Placement

BOSS Compact Pedals have a non-slip rubber pad attached to its bottom cover. Depending on the material and temperature of the surface on which you place the Compact Pedal, the rubber pad may discolor or mar the surface. You can place a piece of felt or cloth under the unit to prevent this from happening. If you do so, make sure the unit will not slip or move accidentally during use.

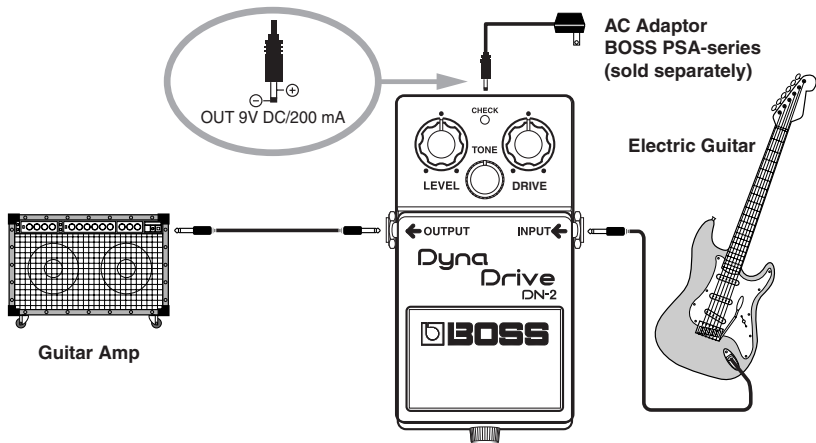

* This unit is equipped with a protection circuit. A brief interval (a few seconds) after power up is required before the unit will operate normally.

Operating the Unit

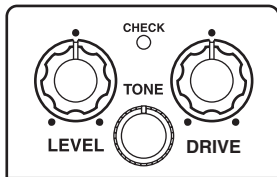

1. After you have made the necessary connections (p. 7, 8), set the panel knobs as shown in the illustration.

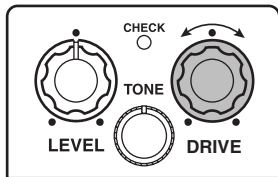

2. Depress the pedal switch to turn the effect on. (The CHECK indicator lights when the effect is on.)
3. Adjust the amount of overdrive with the DRIVE knob.

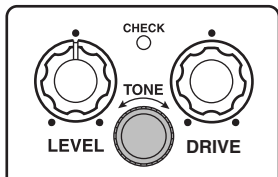

- 4.** Adjust the tone with the TONE knob.

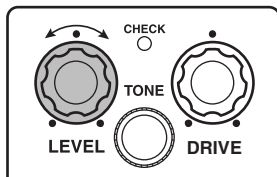

- 5.** Adjust the output volume with the LEVEL knob.

Normally, you should adjust the LEVEL knob so there's no difference in the volume when switching the effect on and off.

Changing the Battery

When the indicator goes dim or no longer lights while the effect is on, it means that the battery is nearly dead and must be replaced. Replace the battery following the steps below.

* *The use of an AC adaptor is recommended as the unit's power consumption is relatively high. Should you prefer to use a battery, please use the alkaline type.*

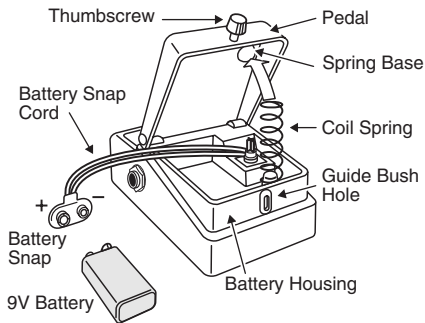

- 1.** Loosen the thumbscrew at the front of the pedal, and then lift the pedal upwards to open the unit.
* *The thumbscrew can be left in the pedal while changing the battery.*
- 2.** Remove the old battery from the battery housing, and remove the snap cord connected to it.
- 3.** Connect the snap cord to the new battery, and place the battery inside the battery housing.
* *Be sure to carefully observe the battery's polarity (+ versus -).*
- 4.** Slip the coil spring onto the spring base on the back of the pedal, and then close the pedal.
* *Carefully avoid getting the snap cord caught in the pedal, coil spring, and battery housing.*
- 5.** Finally, insert the thumbscrew into the guide bush hole and fasten it securely.

Troubleshooting

The power won't come on / the CHECK indicator doesn't light

- **Is the specified adaptor (PSA-series, sold separately) properly connected?**

Check the AC adaptor connection (p. 7, 8).

* *Never use any AC adapter other than one specified for use with the DN-2.*

- **Is the battery low or dead?**

Replace it with a new battery (p. 11).

* *The battery that was supplied with the unit is for temporary use, intended primarily for testing the pedal's operation.*

* *The use of an AC adaptor is recommended as the unit's power consumption is relatively high. Should you prefer to use a battery, please use the alkaline type.*

* *To prevent unnecessary battery consumption, be sure to disconnect the plug from the INPUT jack when not using the effects unit (p. 6).*

- **Is your guitar properly connected to the INPUT jack?**

Check the connection once more (p. 7, 8).

* *A cable must be connected to the INPUT jack to allow the effect to be turned on.*

* *If a cable is connected but no power is supplied to the unit (either from a battery or an AC adaptor), the CHECK indicator will not light when you try to turn the effect on.*

No sound / low volume

- **Is your instrument properly connected to the DN-2?**

Check the connection once more (p. 7, 8).

- **Is the LEVEL knob set too low?**

The further counterclockwise you turn the LEVEL knob, the more the volume is reduced when the effect is on. Turn the LEVEL knob clockwise to increase the volume.

- **Is the volume turned down on any guitar amp or effects device you have connected?**

Check the settings of the connected device.

- **Is the battery low or dead?**

Replace it with a new battery (p. 11).

Setting Samples

DN-2 Overdrive

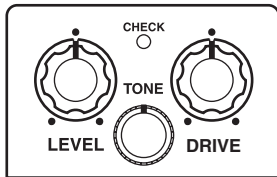

Long Sustain for Solo

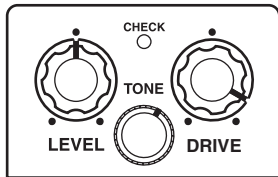

Crunch

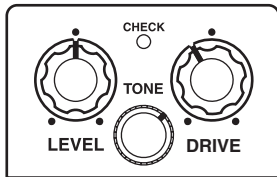

Chord Play

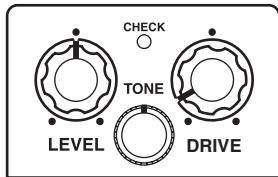

Setting Memo

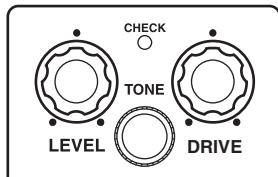
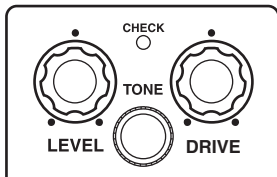
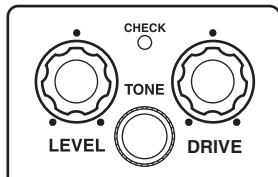
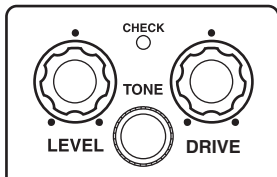

Specifications

DN-2: Dyna Drive

Nominal Input Level.....	-20 dBu
Input Impedance.....	1 M Ω
Nominal Output Level.....	-20 dBu
Output Impedance	1 k Ω
Recommended Load Impedance....	10 k Ω or greater
Controls.....	Pedal switch, LEVEL knob, TONE knob, DRIVE knob
Indicator	CHECK indicator (for effect on/off status and battery check)
Connectors.....	INPUT jack, OUTPUT jack, AC Adaptor jack (DC 9 V)
Power Supply	DC 9 V: Dry battery 6F22 (9 V) type (carbon)/ Dry battery 6LR61 (9 V) type (alkaline) AC adaptor (PSA-series: optional)
Current Draw	36 mA (DC 9 V)

* *Expected battery life under continuous use:*

Carbon: 3 hours, Alkaline: 10 hours

These figures will vary depending on the actual conditions of use.

Specifications

Dimensions	73 (W) x 129 (D) x 59 (H) mm 2-7/8 (W) x 5-1/8 (D) x 2-3/8 (H) inches
Weight	440 g/ 1 lb (including battery)
Accessories.....	Owner's manual, leaflet ("USING THE UNIT SAFELY," "IMPORTANT NOTES," and "Information"), dry battery 6LR61 (9 V) type (alkaline) <i>* The battery that is supplied with the unit is for temporary use, intended primarily for testing the unit's operation. We suggest replacing this battery with an alkaline dry cell.</i>
Options.....	AC adaptor (PSA-series)

* $0\text{ dBu} = 0.775\text{ Vrms}$

* *In the interest of product improvement, the specifications and/or appearance of this unit are subject to change without prior notice.*



This product complies with the requirements of European Directive 89/336/EEC.

For EU Countries

For the USA

FEDERAL COMMUNICATIONS COMMISSION RADIO FREQUENCY INTERFERENCE STATEMENT

This equipment has been tested and found to comply with the limits for a Class B digital device, pursuant to Part 15 of the FCC Rules. These limits are designed to provide reasonable protection against harmful interference in a residential installation. This equipment generates, uses, and can radiate radio frequency energy and, if not installed and used in accordance with the instructions, may cause harmful interference to radio communications. However, there is no guarantee that interference will not occur in a particular installation. If this equipment does cause harmful interference to radio or television reception, which can be determined by turning the equipment off and on, the user is encouraged to try to correct the interference by one or more of the following measures:

- Reorient or relocate the receiving antenna.
- Increase the separation between the equipment and receiver.
- Connect the equipment into an outlet on a circuit different from that to which the receiver is connected.
- Consult the dealer or an experienced radio/TV technician for help.

This device complies with Part 15 of the FCC Rules. Operation is subject to the following two conditions:

- (1) This device may not cause harmful interference, and
- (2) This device must accept any interference received, including interference that may cause undesired operation.

Unauthorized changes or modification to this system can void the users authority to operate this equipment.
This equipment requires shielded interface cables in order to meet FCC class B Limit.

For Canada

NOTICE

This Class B digital apparatus meets all requirements of the Canadian Interference-Causing Equipment Regulations.

AVIS

Cet appareil numérique de la classe B respecte toutes les exigences du Règlement sur le matériel brouilleur du Canada.

 **BOSS**[®]
BOSS Corporation



This product must be disposed of separately
at your local waste recycling centre.
Do not dispose of in household waste bin.

G6027117R0