

90min

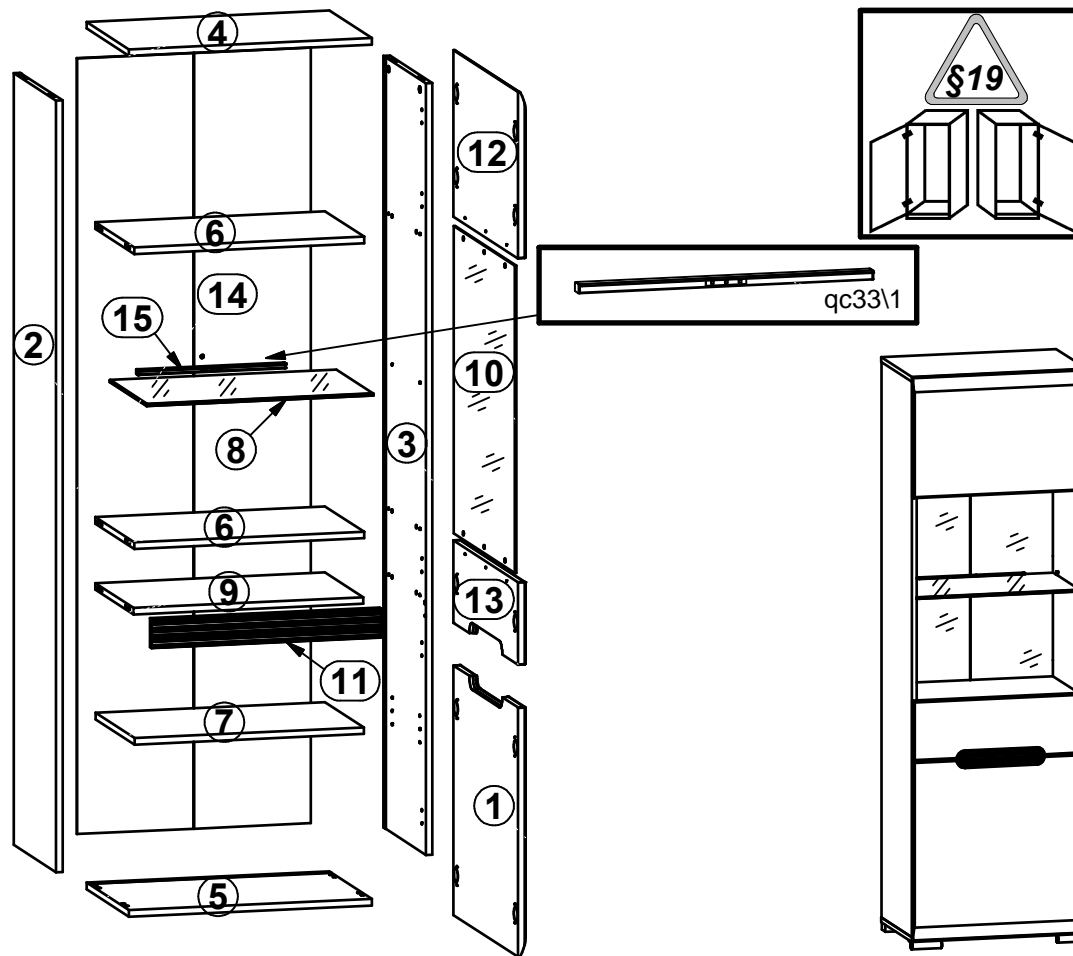

		S1		S11	
A	B	C (mm)		D	
1	S205-030	604	596	2/2	
2	S205-143	1868	390	1/2	
3	S205-144	1868	390	1/2	
4	S205-203	600	390	1/2	
5	S205-204	600	390	1/2	
6	S205-316	567	360	1/2	
7	S205-317	566	360	1/2	
8	S205-318	560	340	2/2	
9	S205-322	567	354	1/2	
10	S205-554	744	563	2/2	
11	S205-572	567	70	2/2	
12	S205-714	403	596	2/2	
13	S205-722	200	596	2/2	
14	S205-9908	1878	577	1/2	
15	qc33\1			1/2	



5x a102	5x b59	4x d1	4x d33	4x e1	6x e47	22x f1	2x k84	2x k85	18x l1	18x l2	6x o54	6x p38
10x p51	4x p6	18x r1	18x r42	5x s33	10x s4	10x s59	12x s2	1x z1	2x f35	2x n14\2	2x p17	4x p38

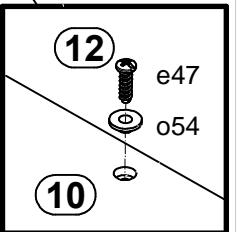
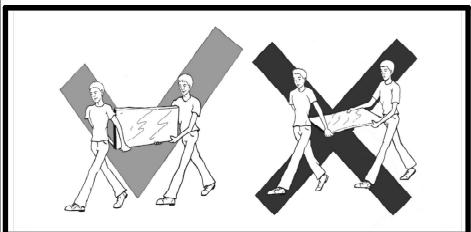
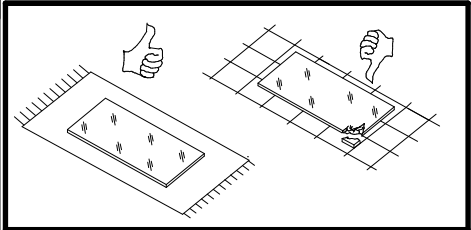
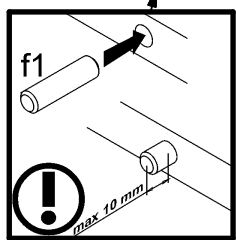
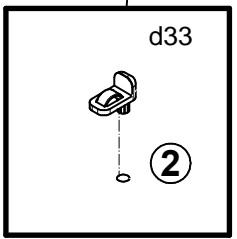
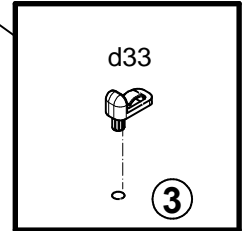
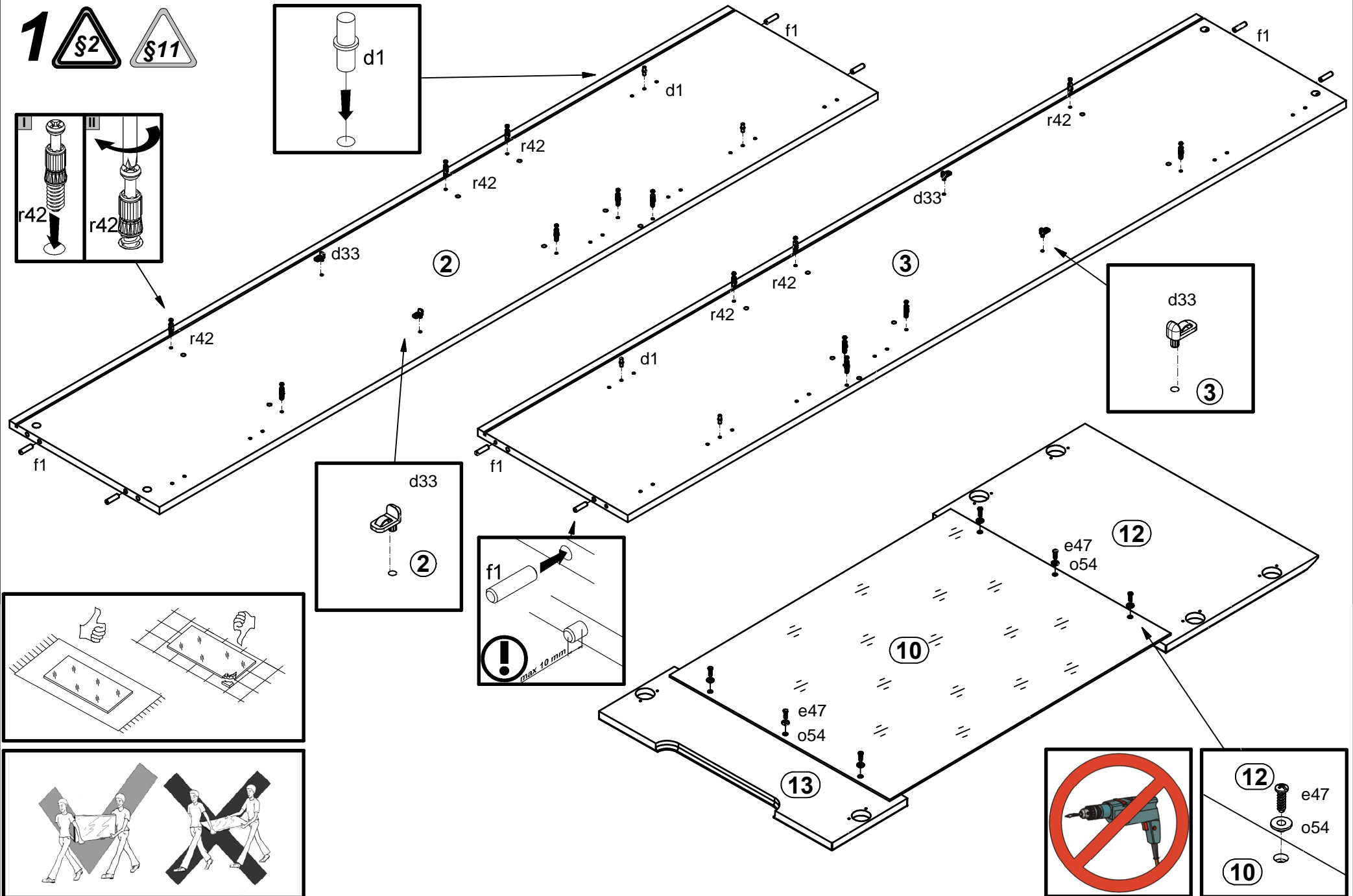
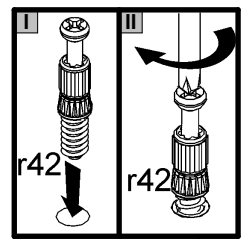
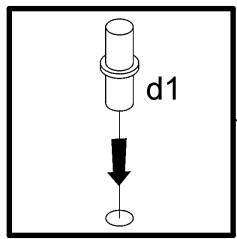

2

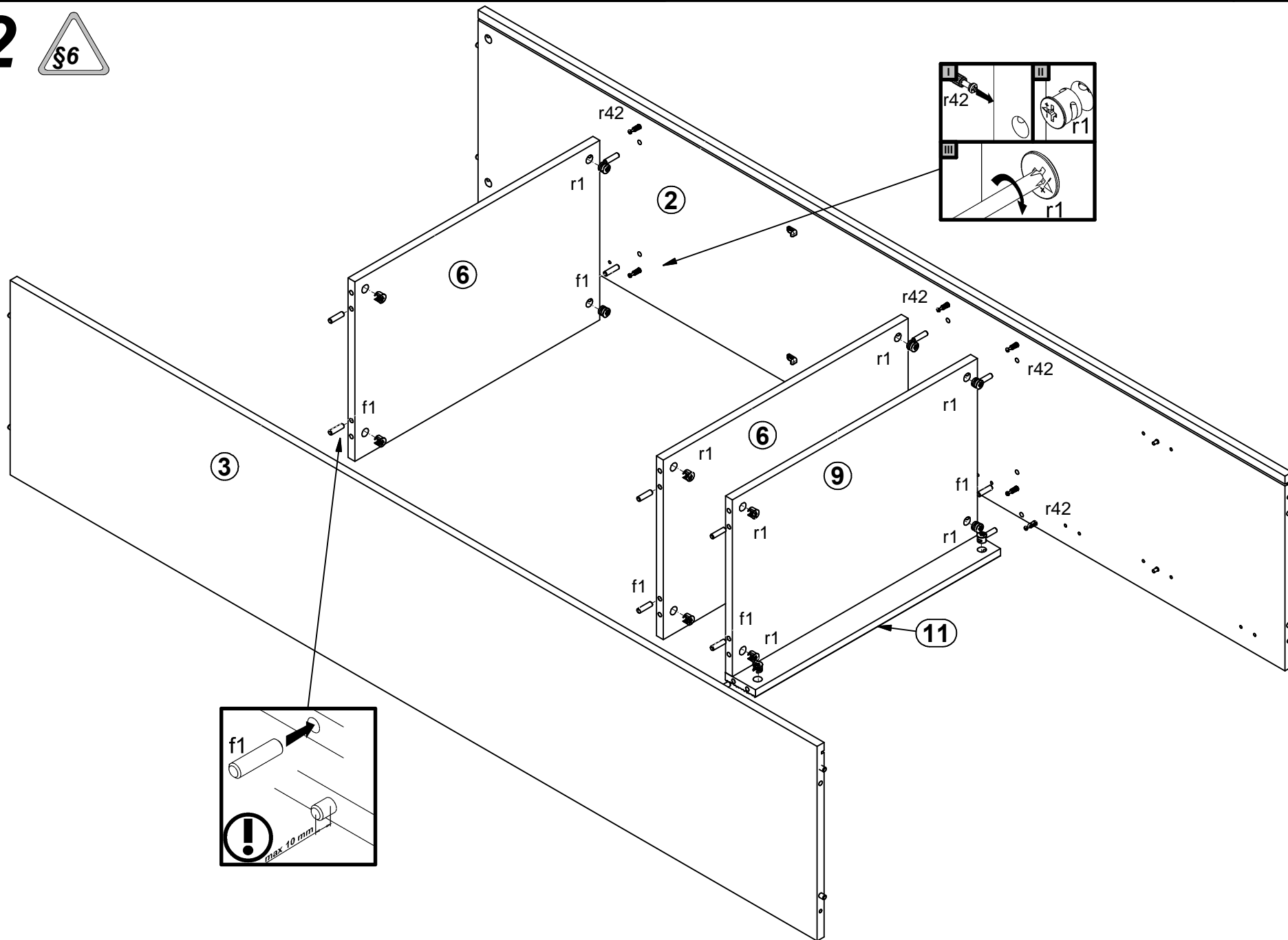

3

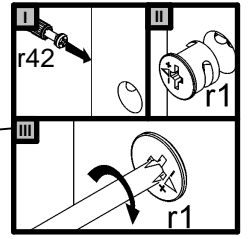
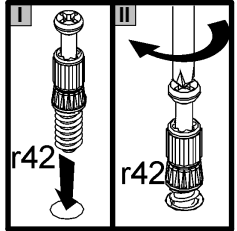
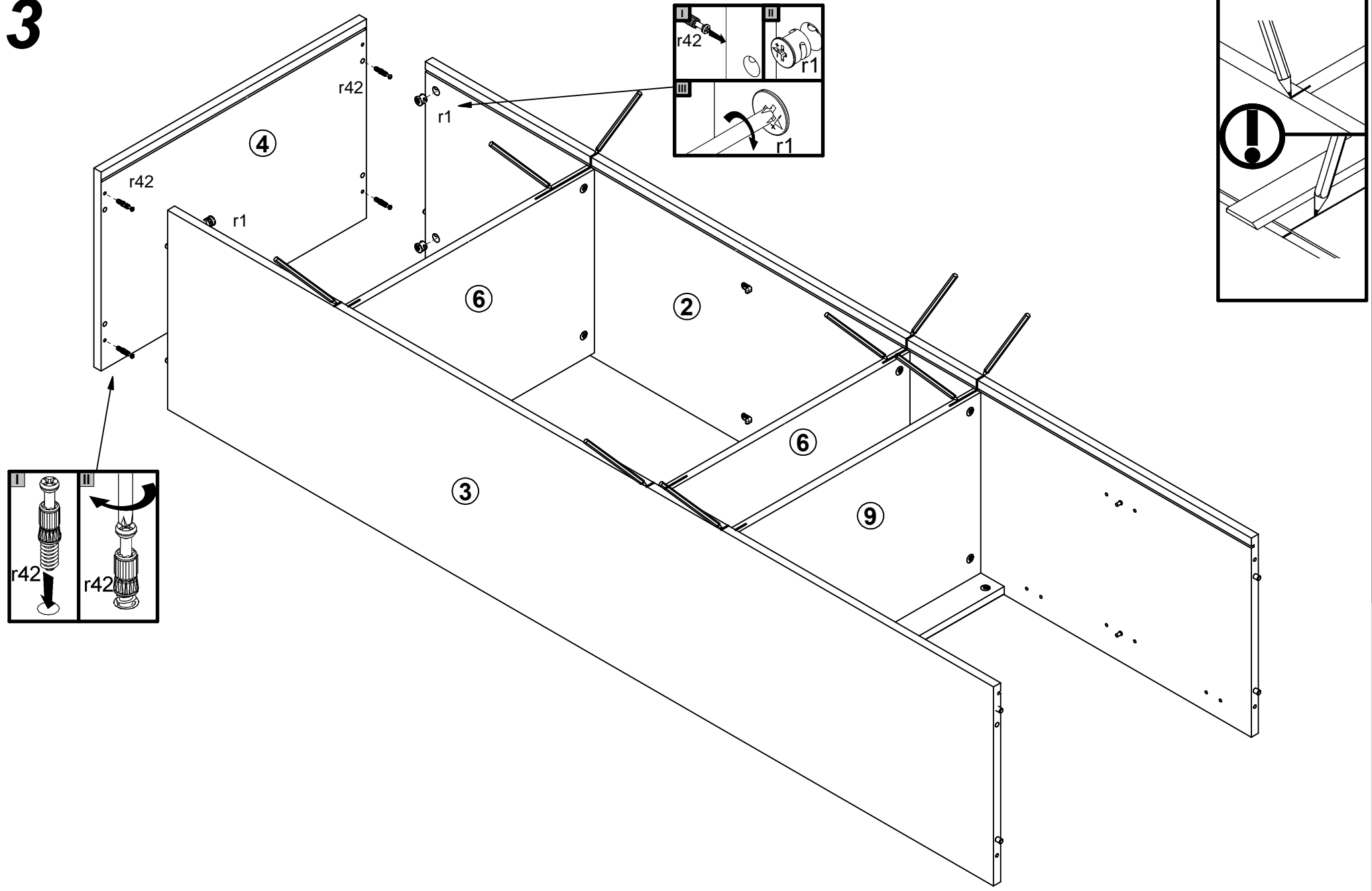

5

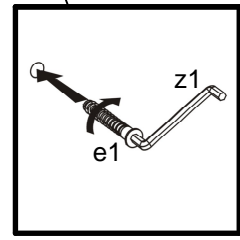
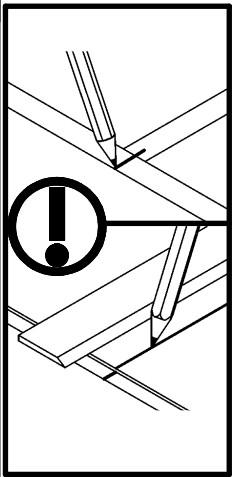
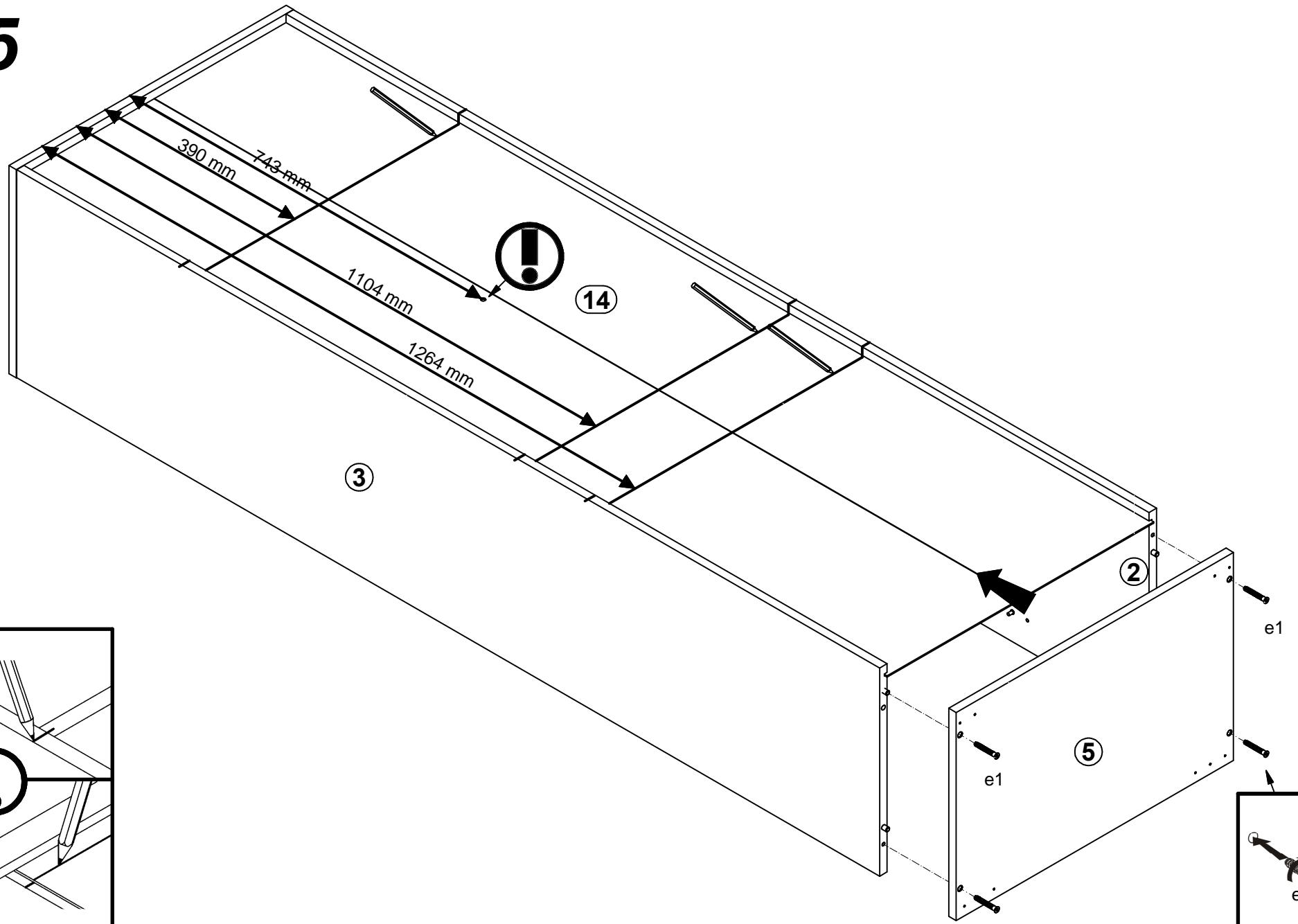

6

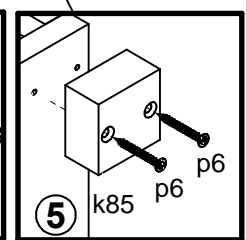
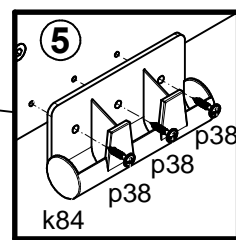
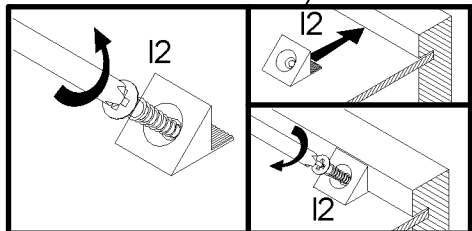
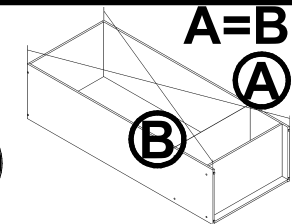
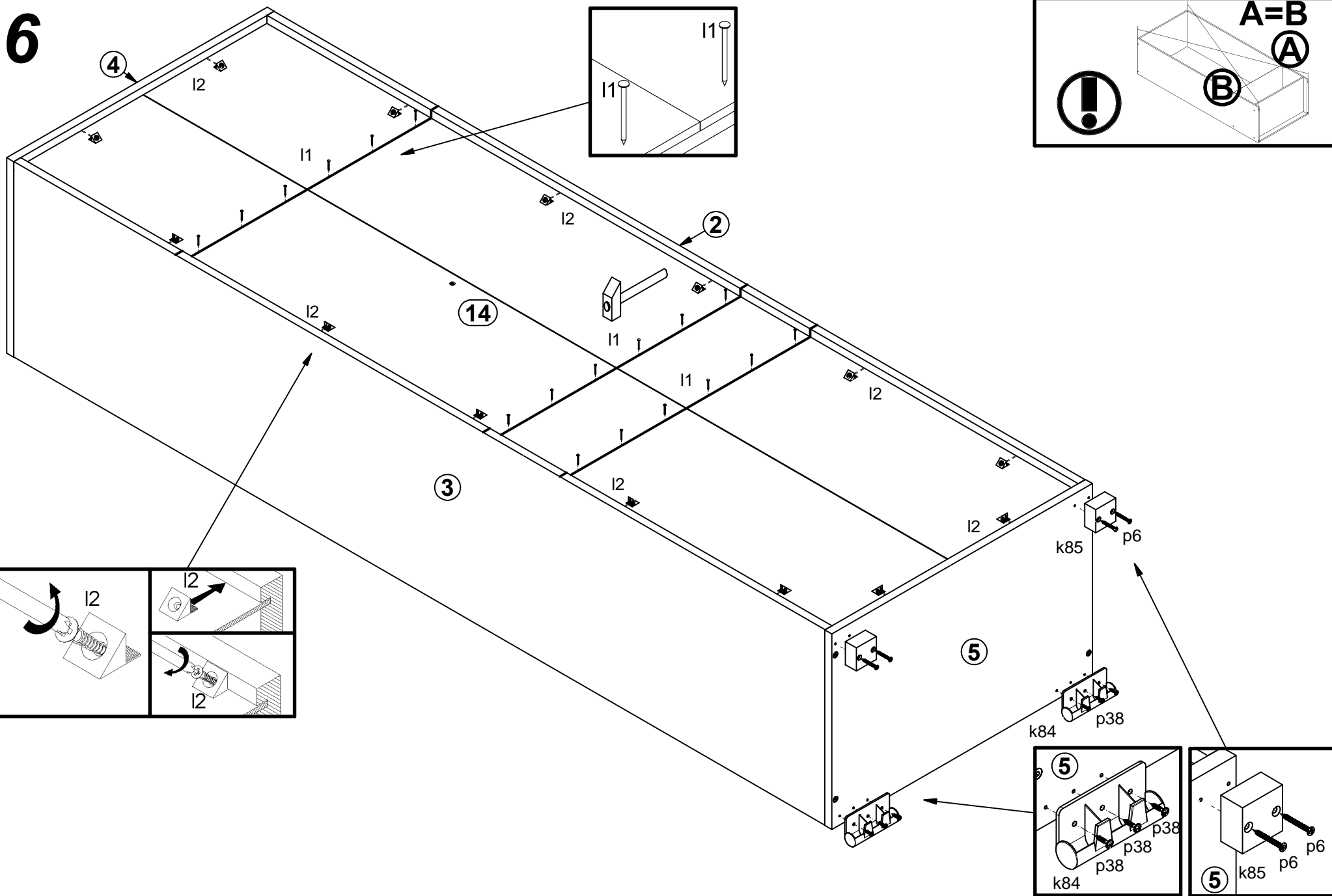

7

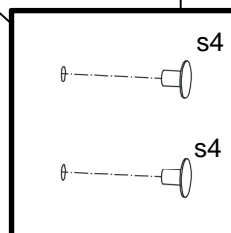
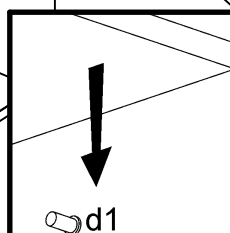
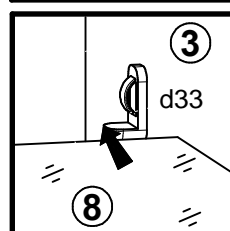
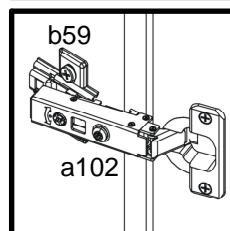
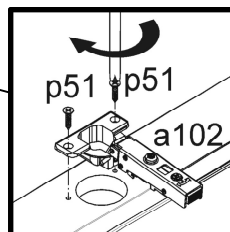
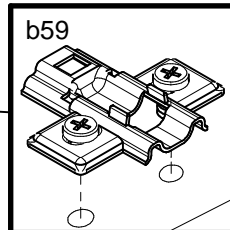
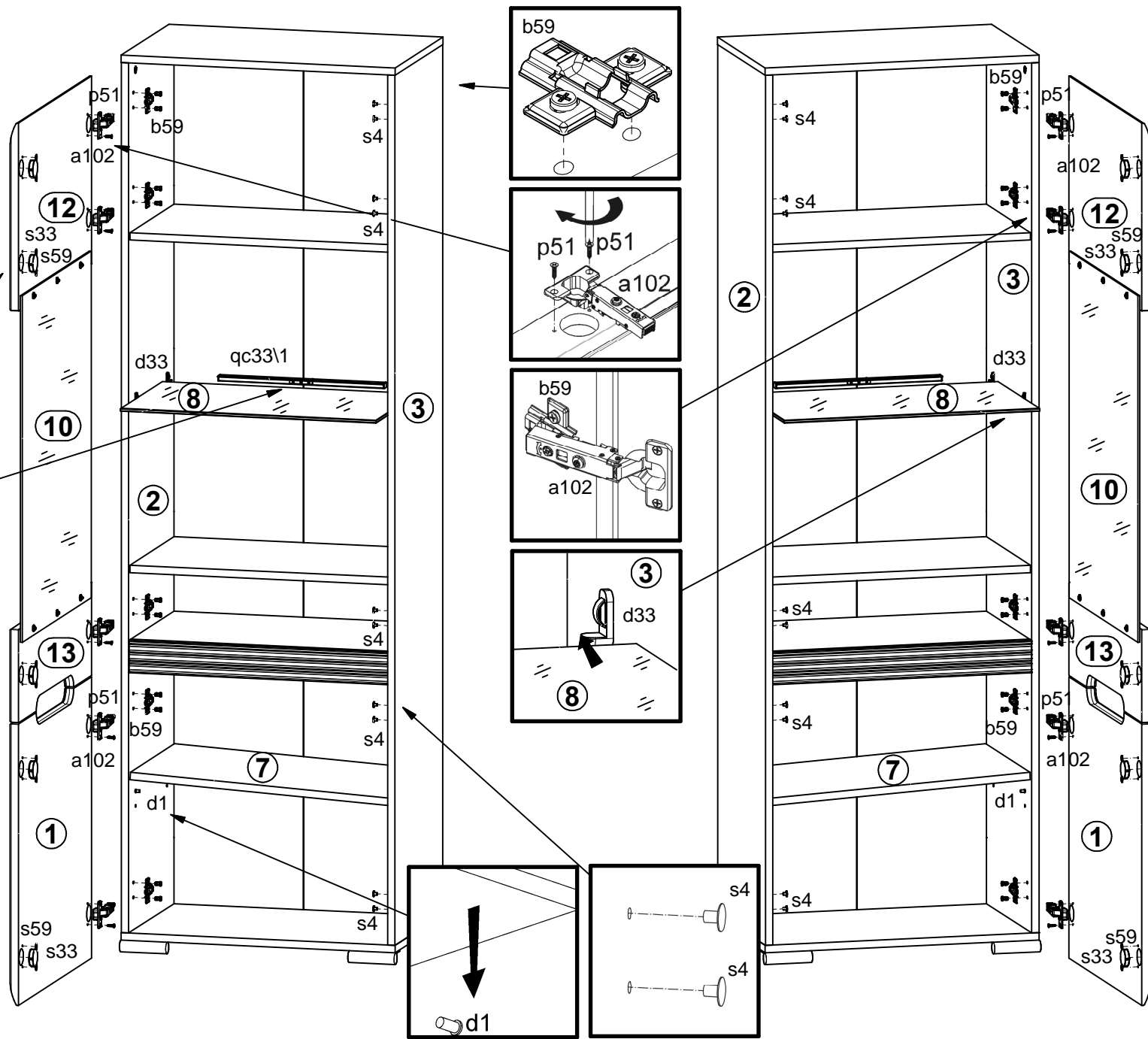
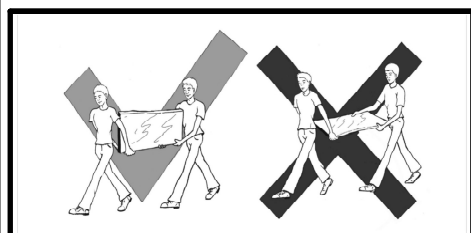
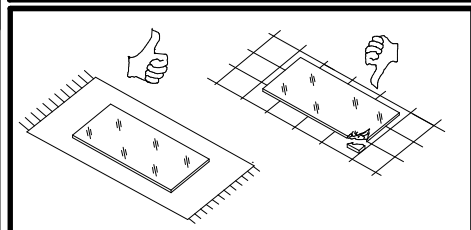
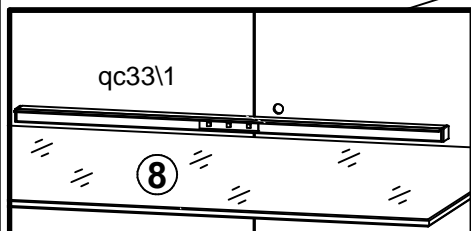
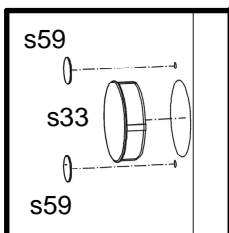
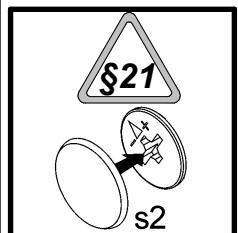
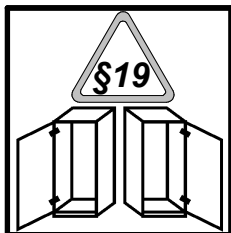

8

