

90min

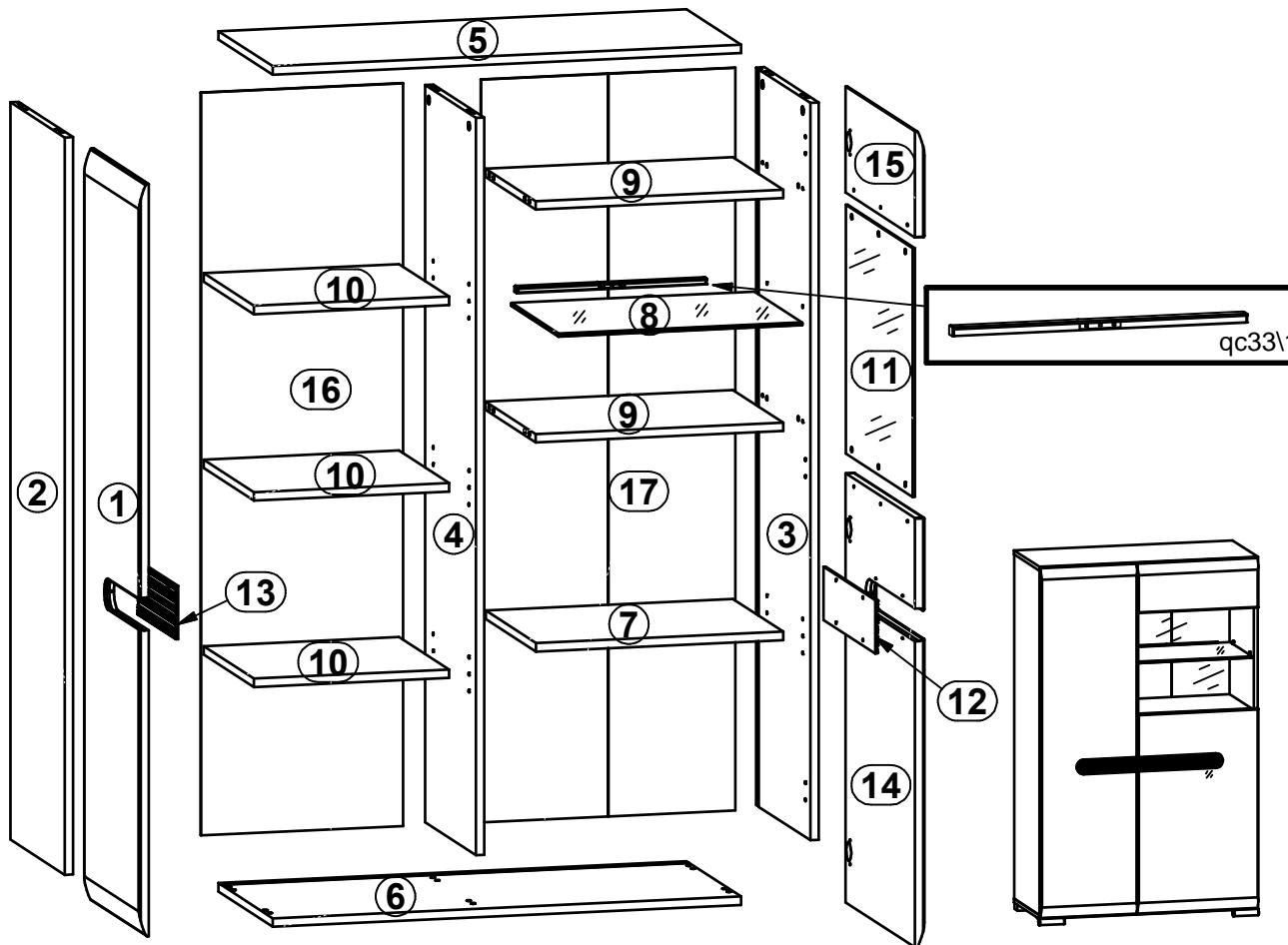

A	B	C (mm)		D
1	S205-029	1418	396	3/3
2	S205-140	1390	390	2/3
3	S205-141	1390	390	2/3
4	S205-142	1390	364	2/3
5	S205-223	900	390	1/3
6	S205-224	900	390	1/3
7	S205-306	475	360	1/3
8	S205-308	469	340	1/3
9	S205-314	475,5	360	1/3
10	S205-315	375	360	1/3
11	S205-556	480	469	3/3
12	S205-583	370	100	3/3
13	S205-586	270	100	3/3
14	S205-717	809	496	3/3
15	S205-719	200	496	3/3
16	S205-916	1400	388	2/3
17	S205-9907	1400	489	2/3
18	qc33\1			1/3



6x a102	6x b59	16x d1	4x d33	6x e1	6x e47	20x f1	2x k84	3x k85	15x l1	18x l2	9x n108	6x o54
14x p38	12x p51	9x p55	6x p6	14x r1	14x r42	14x s2	1x z1	1x n261	1x p38			

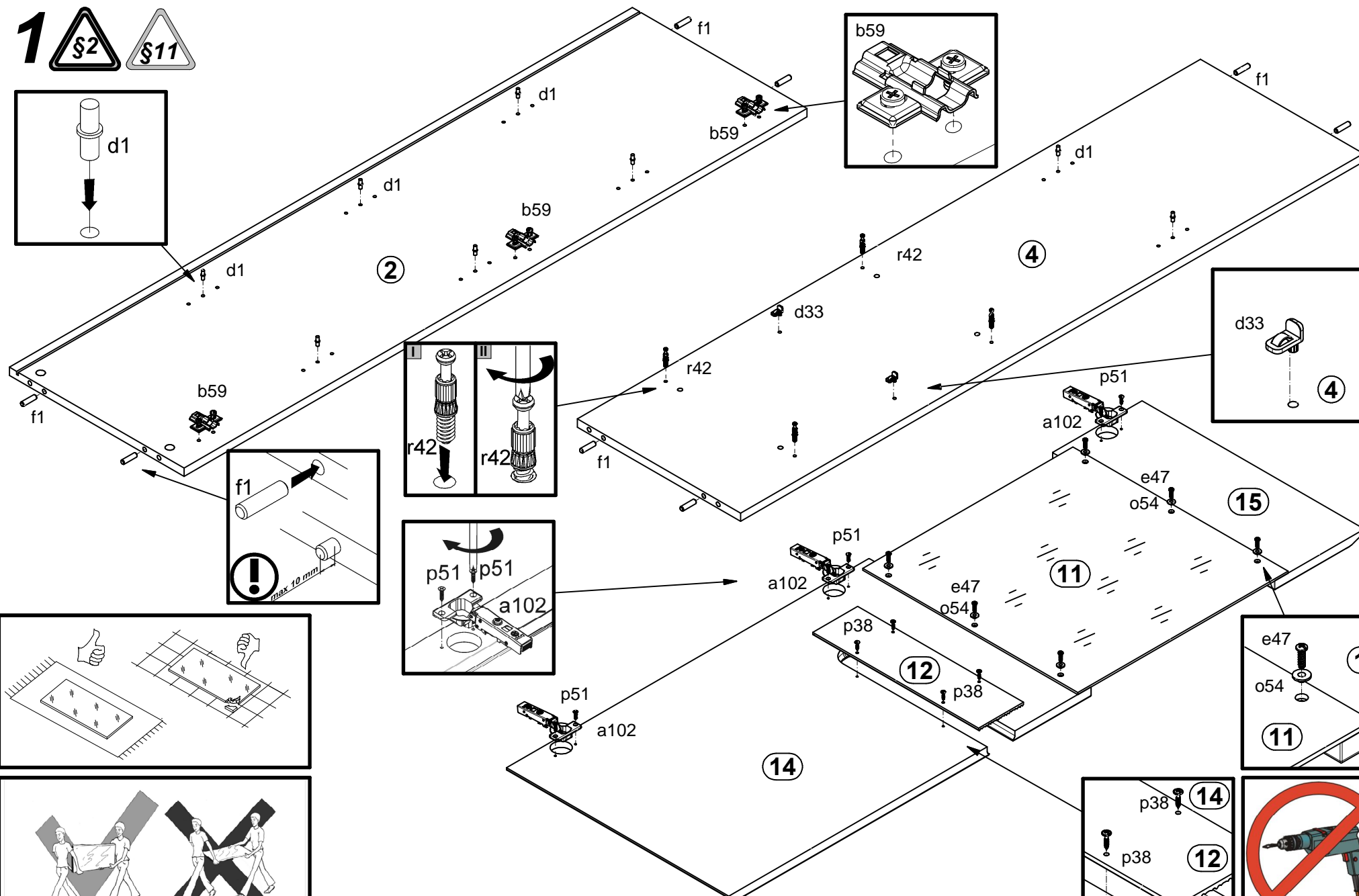
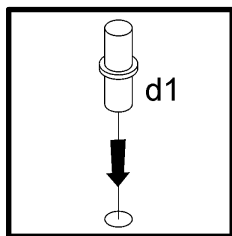

2

4

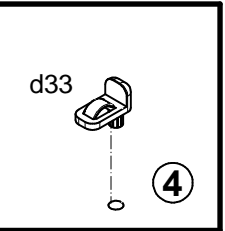

4

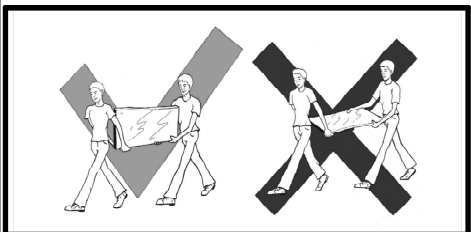
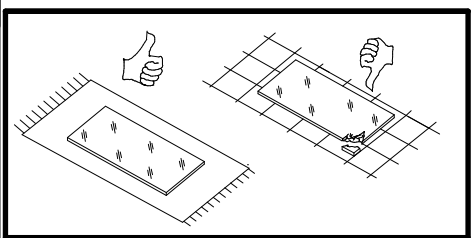
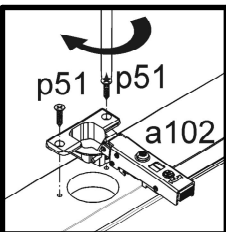
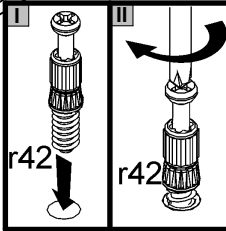
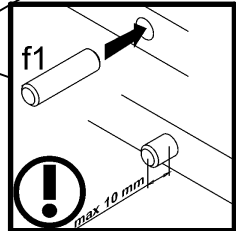

15

11

12

14

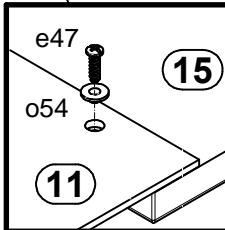

15

11

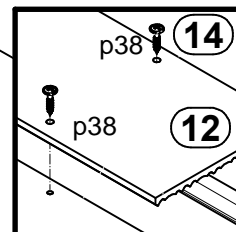

14

12

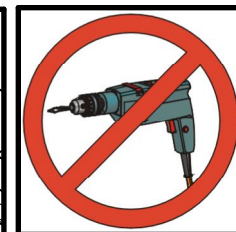

2

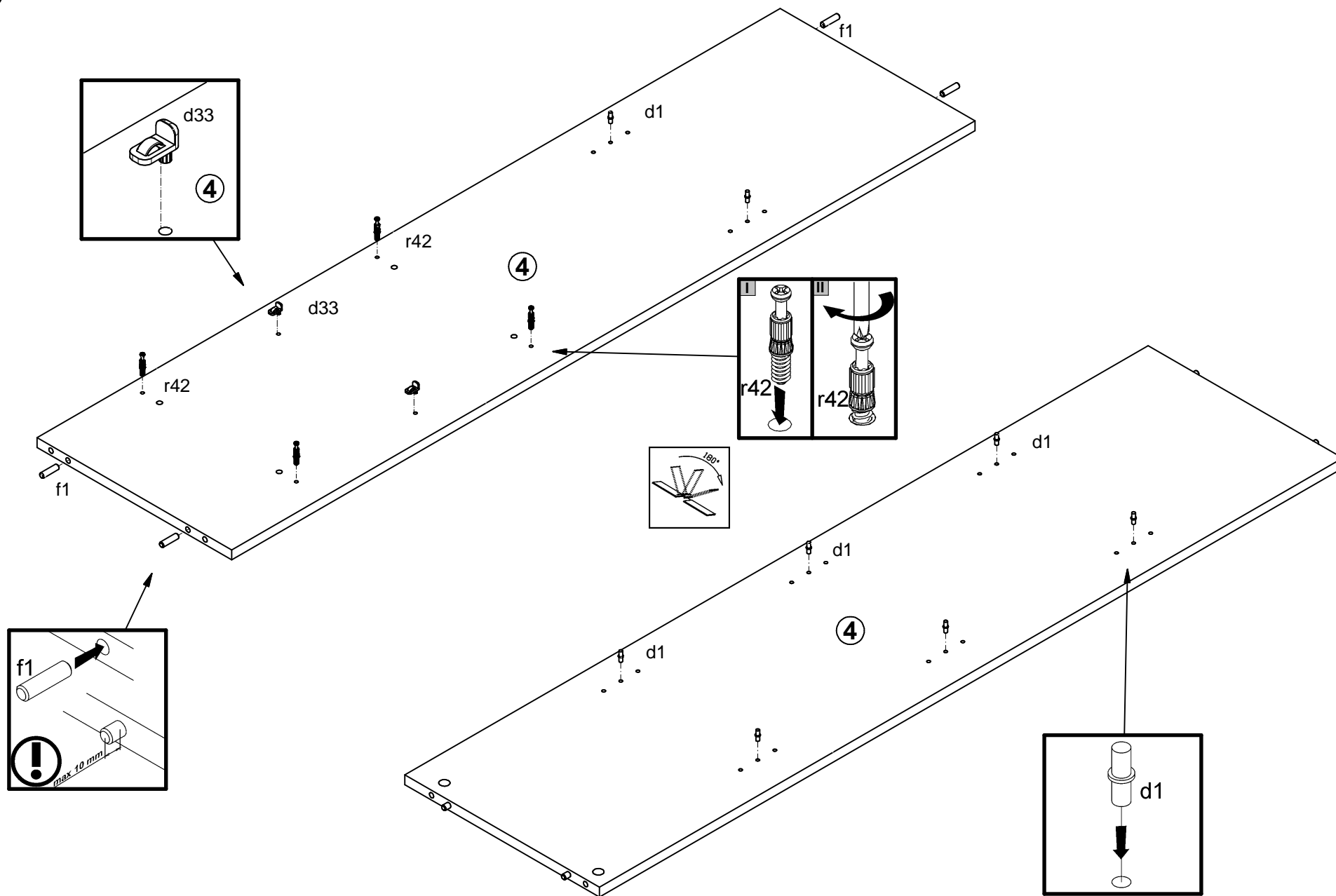

3

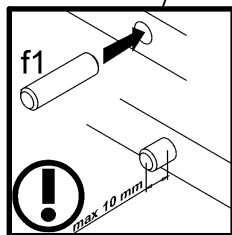
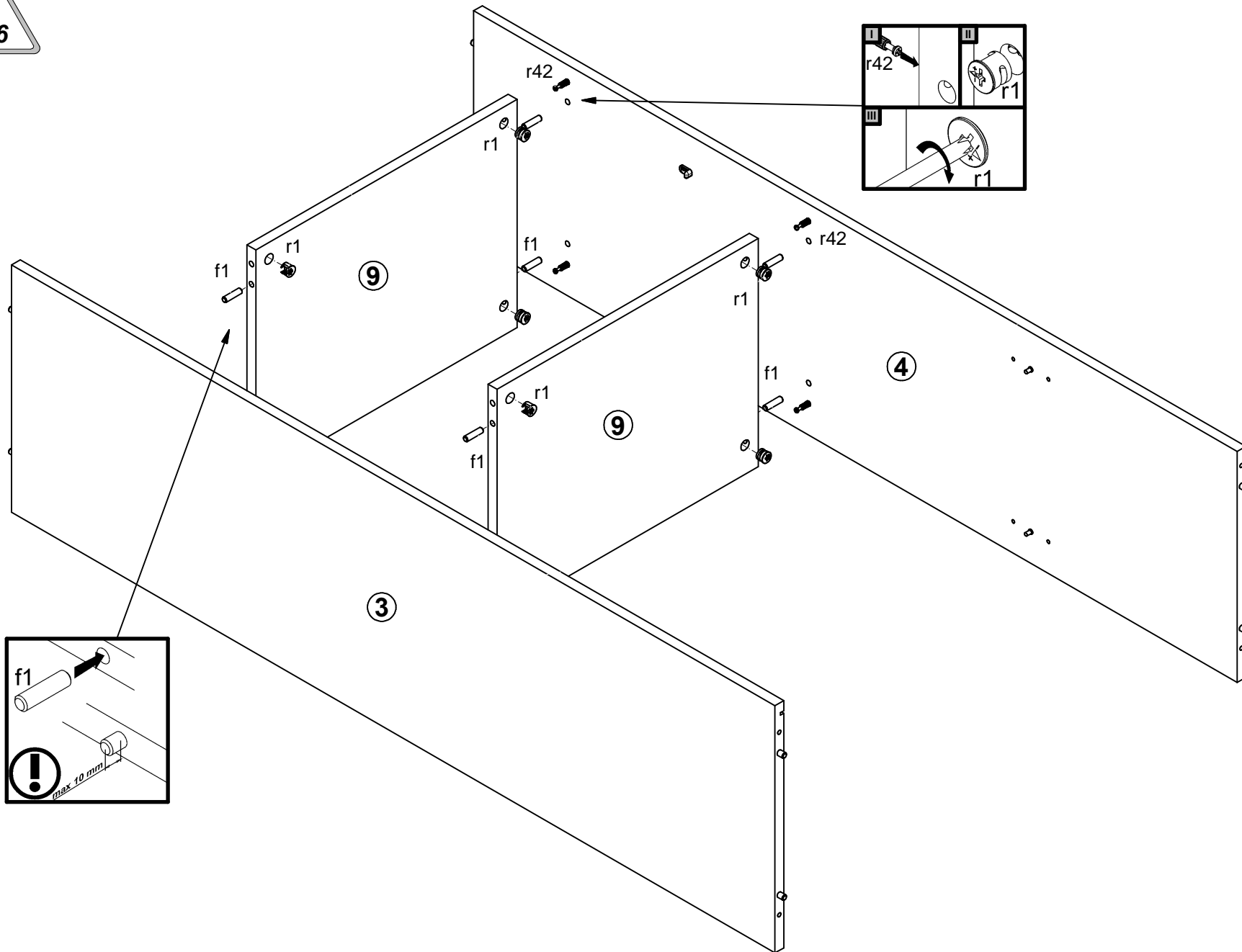

4

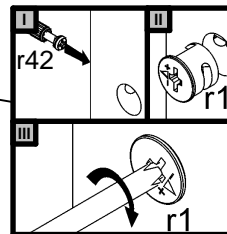
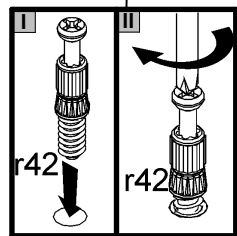
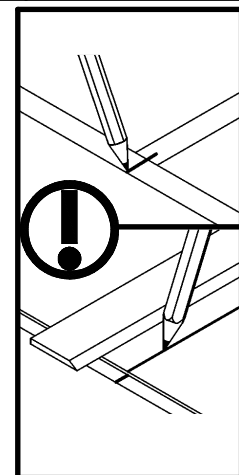
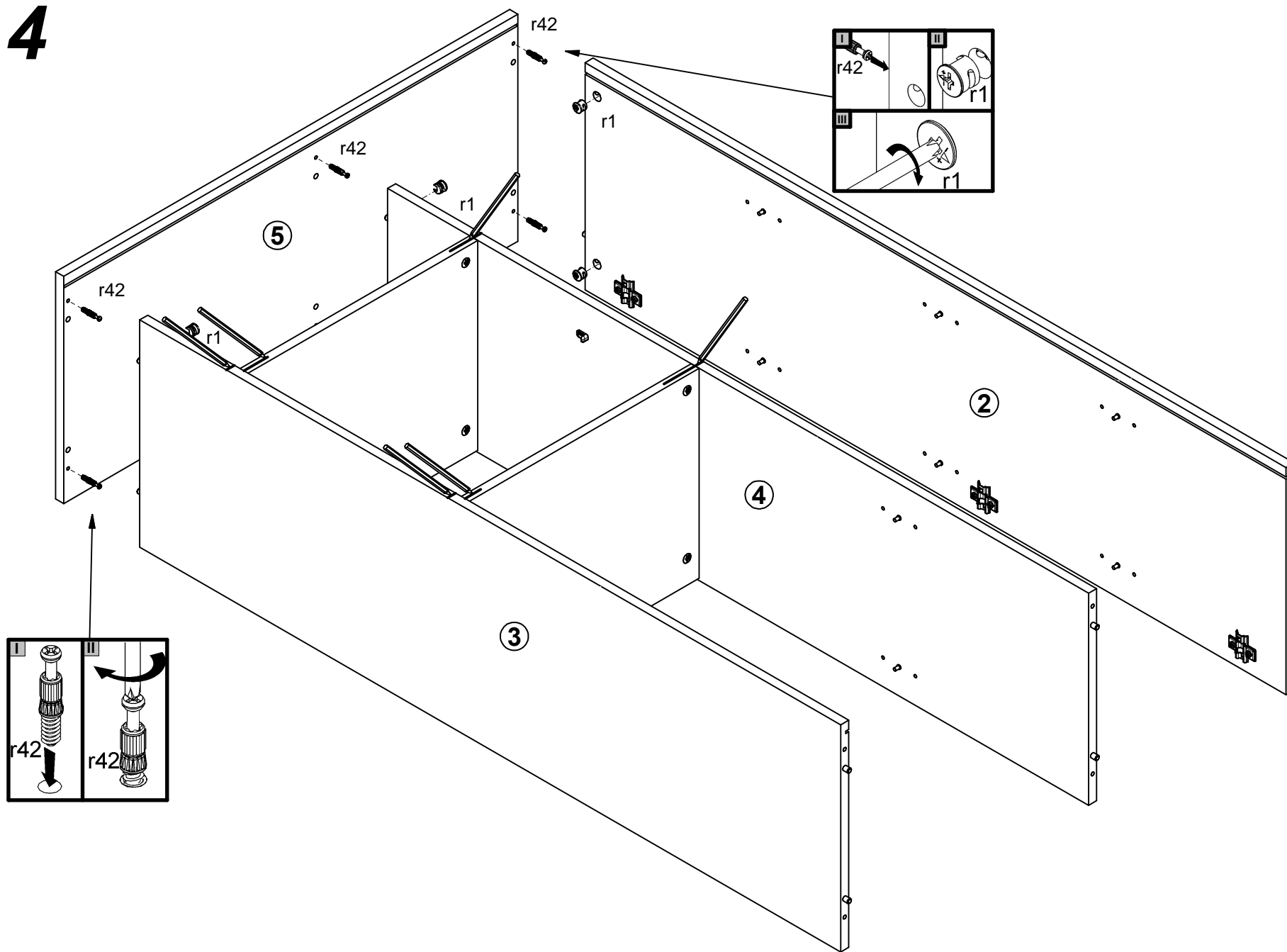

5

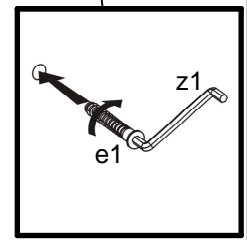
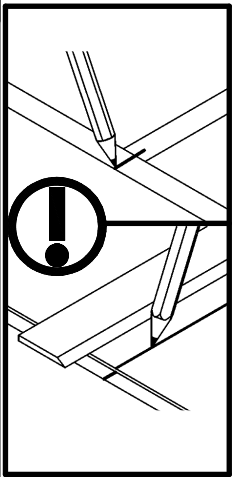
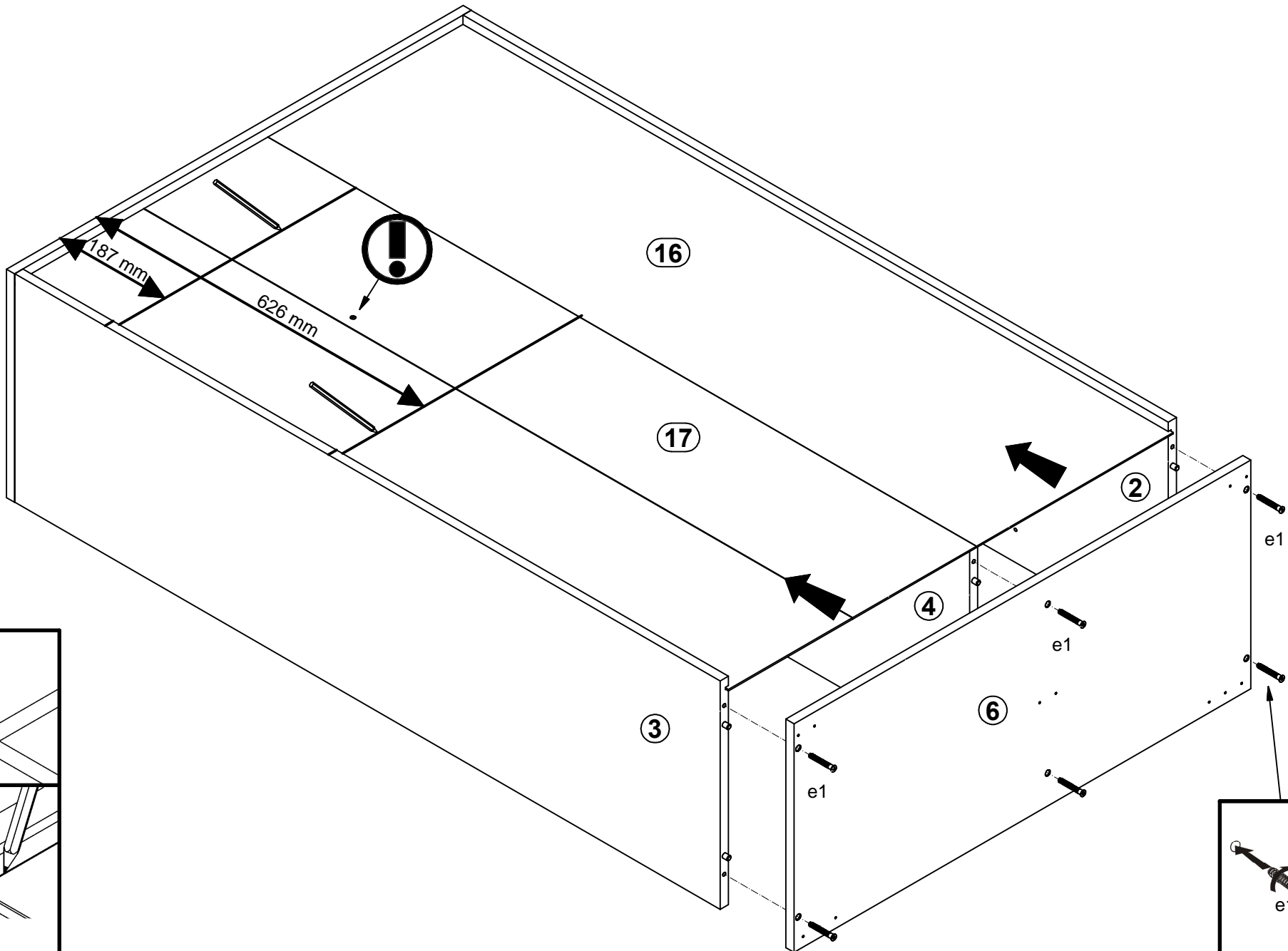

6

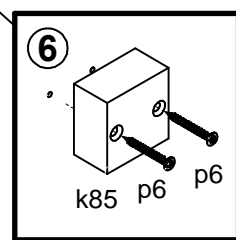
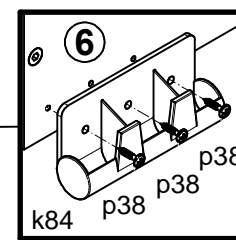
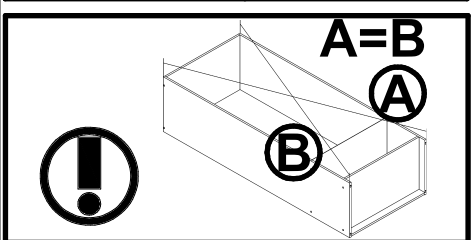
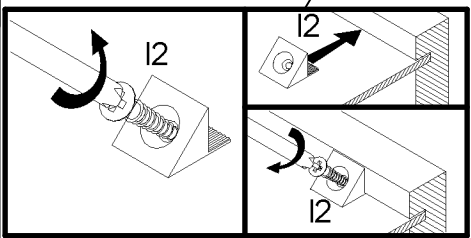
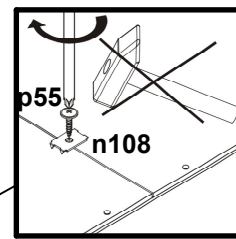
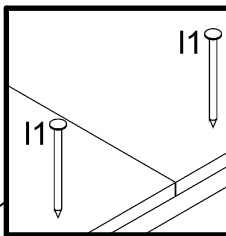
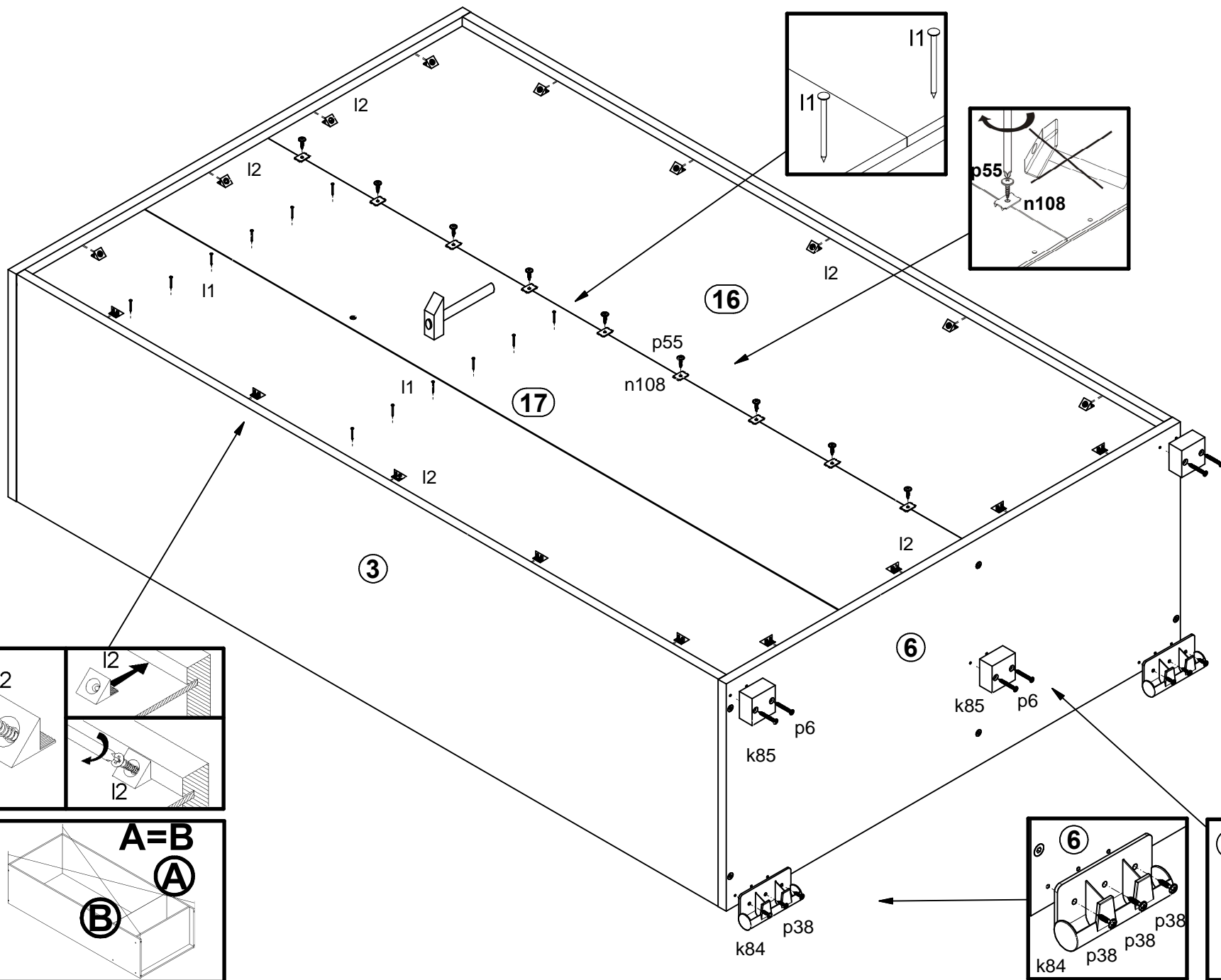

7

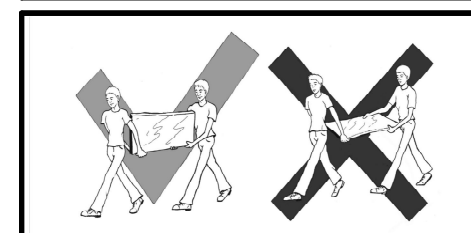
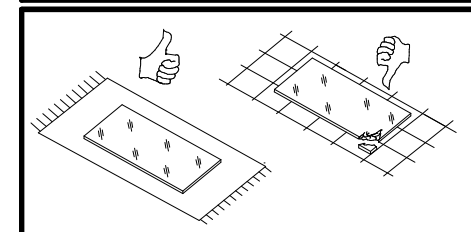
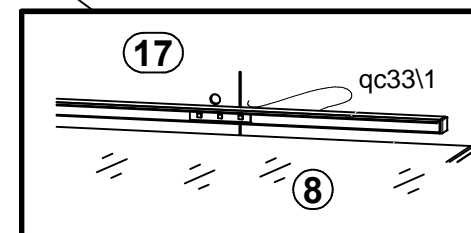
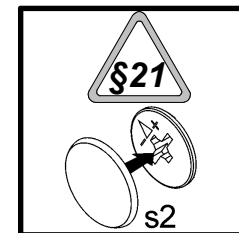
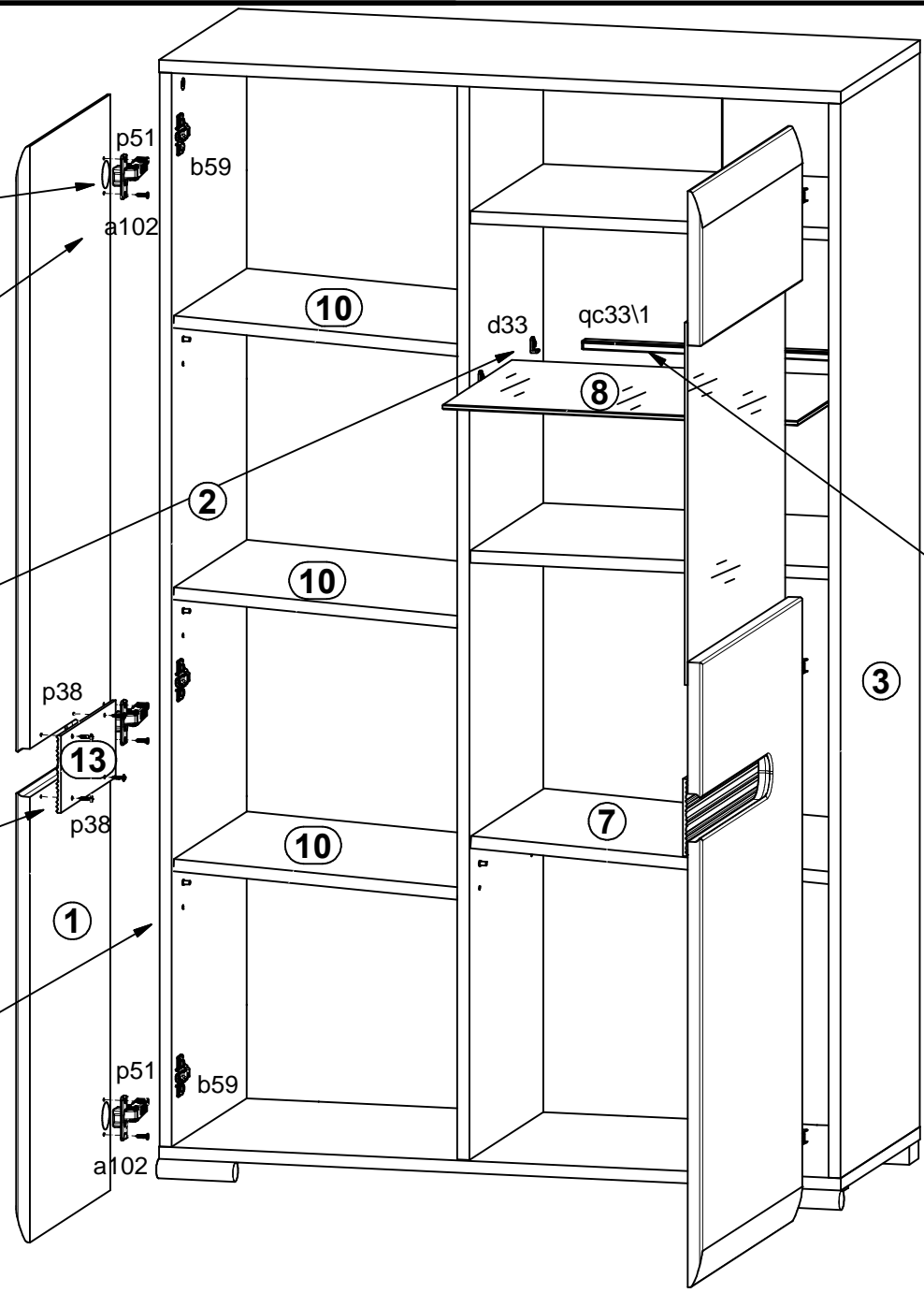
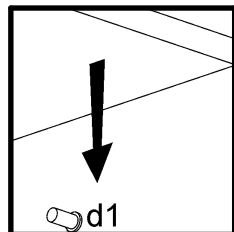
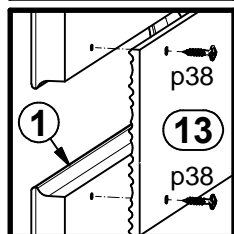
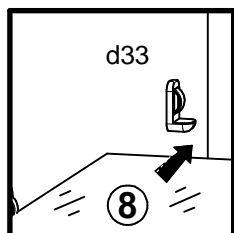
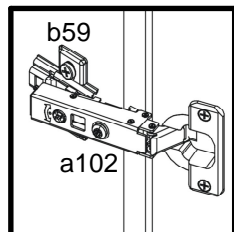
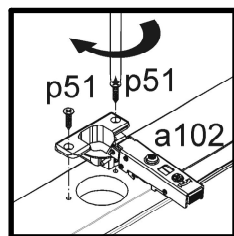

8

