

DHT83LIN

TUMBLE DRYER, FREE-STANDING, WHITE,
ENERGY RATING A+++

EAN13: 8017709209513

Condensing with heat pump drying

16 programs

Dimensions of the product (mm): 846x595x609

Load capacity (cotton): 8 kg

Electronics controls

Display: Delay timer, Rest time indication,
Visualisation of the selected options

Drum volume: 118 lt

Stainless steel drum

Time drying selection from 10 up to 160 min

Dying temperature regulation

Delay timer option 24 hours

End cycle acoustic signal function

Wopolmark code: M14029

Cooling down phase

Indicator condense container full

Clean filter indicator

Condenser filter

Fluffy filter

Installation with or without draining pipe

Current: 10 A

Frequency: 50 Hz

230-240 V



Functions



Plus and
Options

Programs



Plus and Options

 **A+++:**
Appliances with this symbol can reduce energy consumption by a further 30% from the standard A energy rating.

 **Drying capacity 8 Kg:**
Drying capacity 8 Kg

 **Delay timer:**
can be set to run the programme at a convenient time or to take advantage of off-peak energy periods.

 **Easy Iron:**
this is an option which can be selected to ensure the finished laundry is left with less creases to make ironing easier.

 **Humidity sensor:**
allows to adjust dryer to obtain the desired drying level (Iron dry, Cupboard dry and Extra dry), saving time and reducing energy consumption. In addition, manual adjusting allows you to program drying time according to your preferences.

 **40cm:**
Large loading hatch of 40 cm in diameter, makes laundry loading and unloading easier and faster with maximum ease of use.

 **End:**
Show the stage at which the program is in progress: the program has finished.

 **Shows the phase of program:**
Shows the phase in which the program is being.

 **Noise level:**
Excellent insulation and special devices keep noise to a minimum.

 **Child lock:**
some models are fitted with a device to lock the programme/cycle so it cannot be accidentally changed.

 **Internal lights:**
help to illuminate the inside of the drum.

 **LCD display:**
to show programmes, functions and options selected and the time to the end of the cycle.

 **Inverter technology:**
The evolution of Smeg's driers towards more intelligent and environmentally sustainable models has led to the choice of using Inverter technology with heat pumps, which reduces significantly energy consumption.

Programs

 **Refresh:**
an ideal program to refresh the garments that have been kept for a long time indoors and eliminate unpleasant odors, without having to wash

 **Super fast 49 min:**
a programme designed to wash small amounts of laundry fast, ideal for washing lightly soiled garments.

 **Delicate:**
Clothing such as underwear, hosiery and luxury fabrics should be dried on the delicate cycle to help extend the life of the clothing.

**Baby:**

a cycle which ensures a high efficiency in the rinse to remove all traces of detergent from the tissues and protect the delicate children's skins.

Woolmark Apparel Care:

For Washing Machines: The wool wash cycle of this machine has been approved by The Woolmark Company for the washing of machine washable wool products provided that the products are washed according to the instructions on the garment label and those issued by the manufacturer of this washing machine. Per Dryers: The wool drying cycle of this machine has been approved by The Woolmark Company for the drying of machine washable wool products provided that the products are washed and dried according to the instructions on the garment label and those issued by the manufacturer of this machine.





DHT83LIN

dryer
free standing
60 cm
white
energy rating A+++
front loading

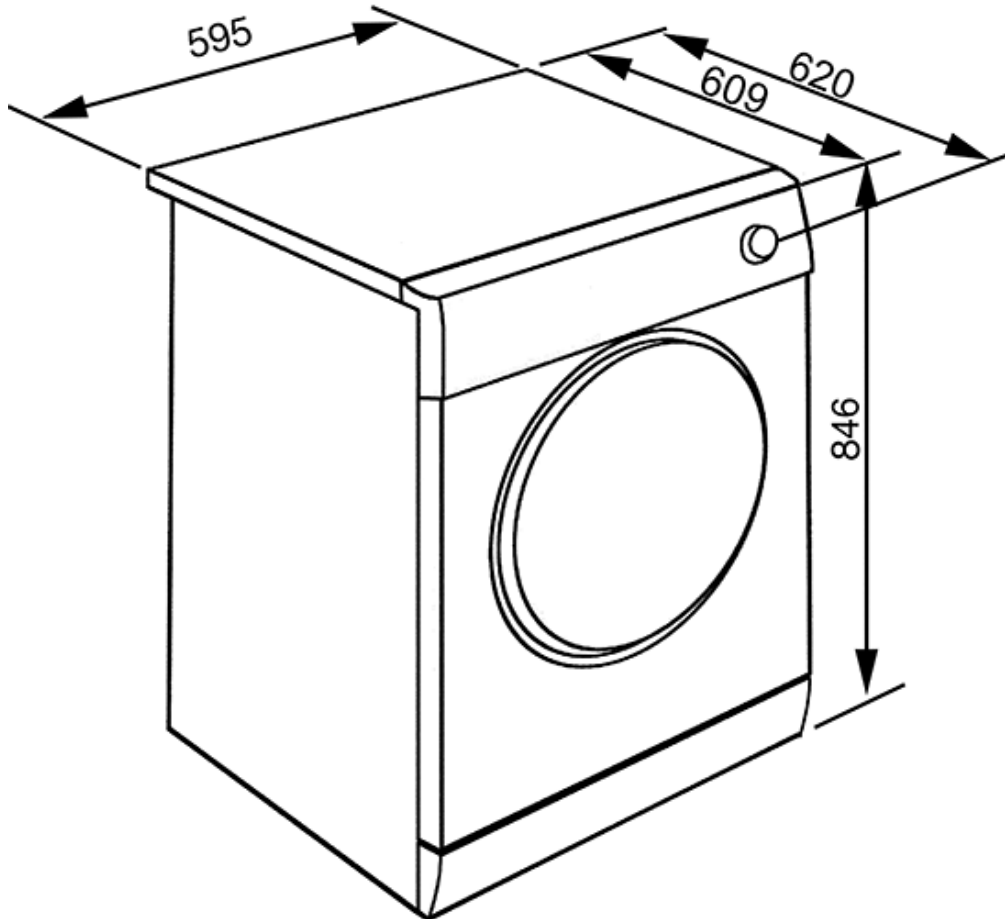

SMEG S.p.A.
Via Leonardo da Vinci, 4
42016 Guastalla (RE)
Tel. 0522 821 1