

4 Assembly instructions Trebuche

26

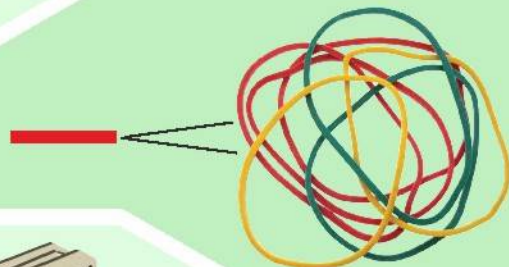

27

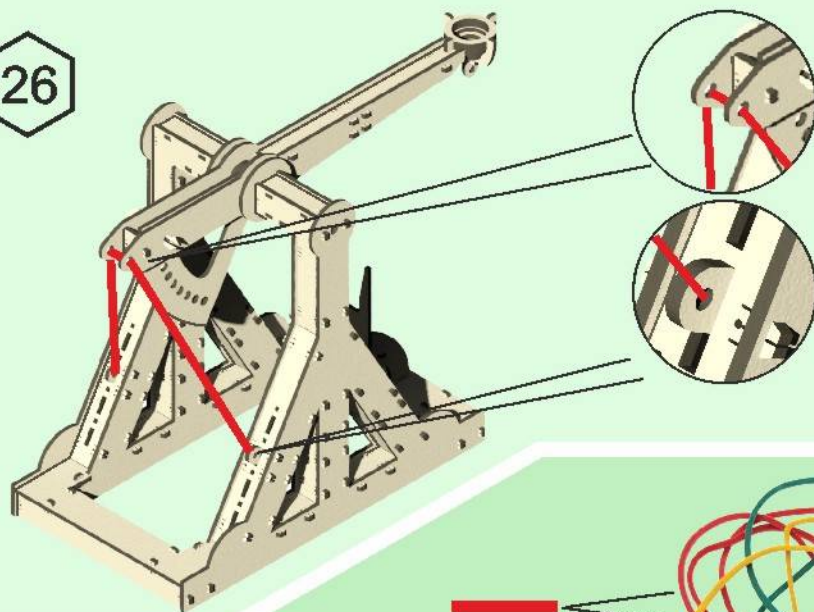
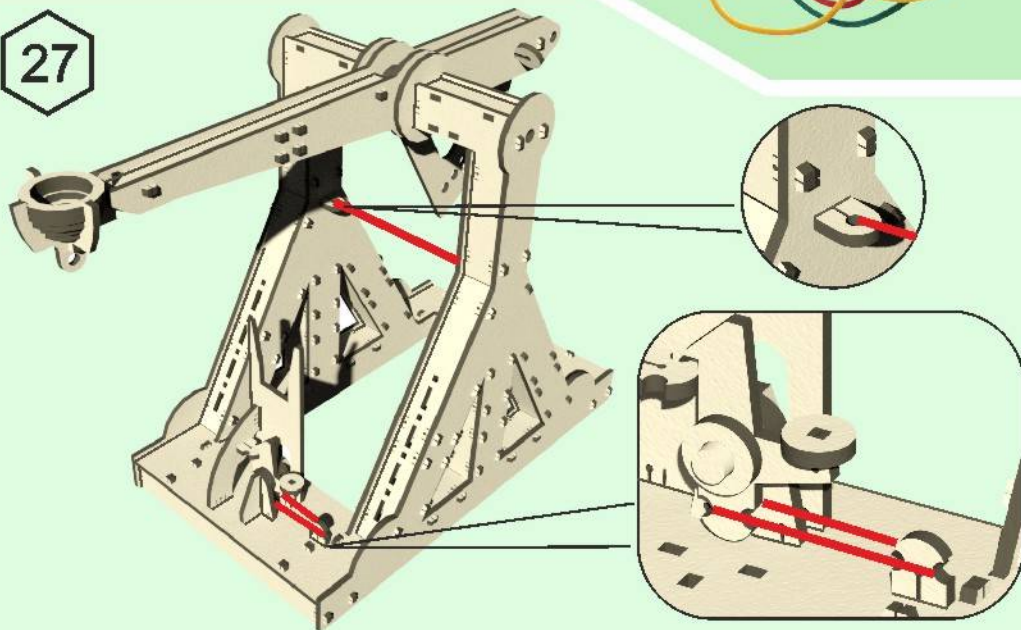

Инструкция

по сборке модели "Требушет"
Assembly instruction for model "Trebuchet"
Le istruzioni per il montaggio del modello "Trebuchet"

Для сборки необходимо использовать
любой клей для дерева!
For the assembly you can use any wood glue!
Per il montaggio si deve utilizzare qualsiasi colla per legno

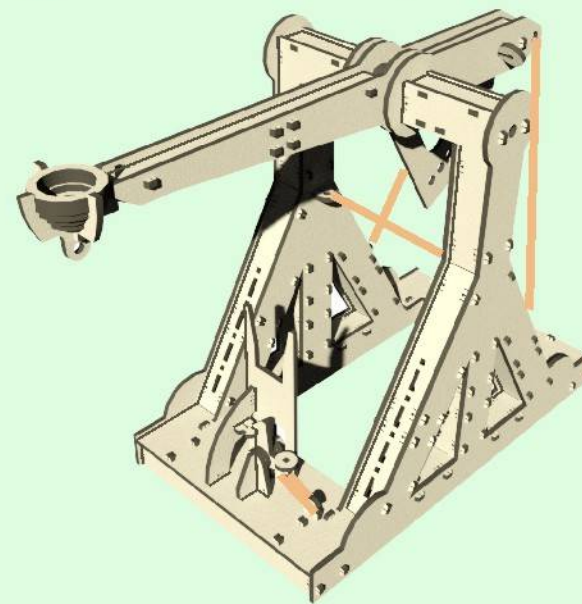

Сборка без клея до щелчка /
The assembly without glue to the sound /
Montaggio senza colla fino allo scatto



Древесина подвержена воздействию влаги. Для лучшего соединения/входа деталей
использовать свечку, канцелярский нож, наждачную бумагу или подсушить изделие!
Wood exposed to moisture. For the best connection/login details to use a candle,
a box cutter, sandpaper, or dry the product!
Il legno è esposto ad umidità. Per una migliore connessione/inserimento dei dettagli
si deve utilizzare candela, coltello di cancelleria, carta abrasiva o far asciugare il prodotto

1 Assembly instructions Trebuchete

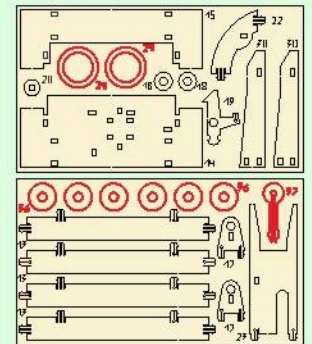
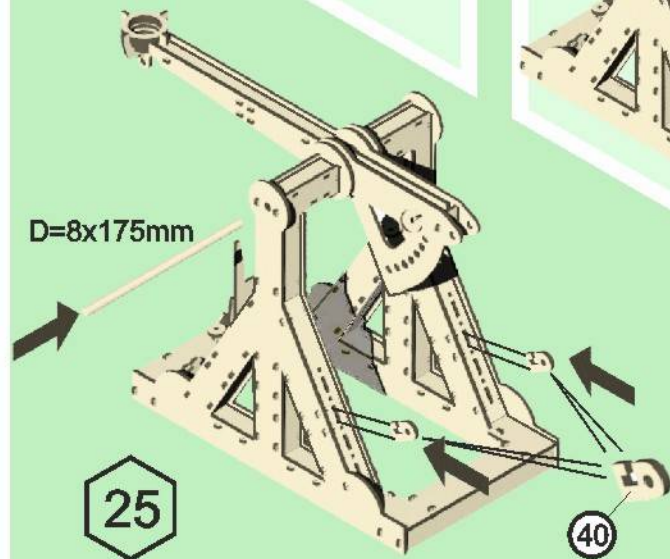
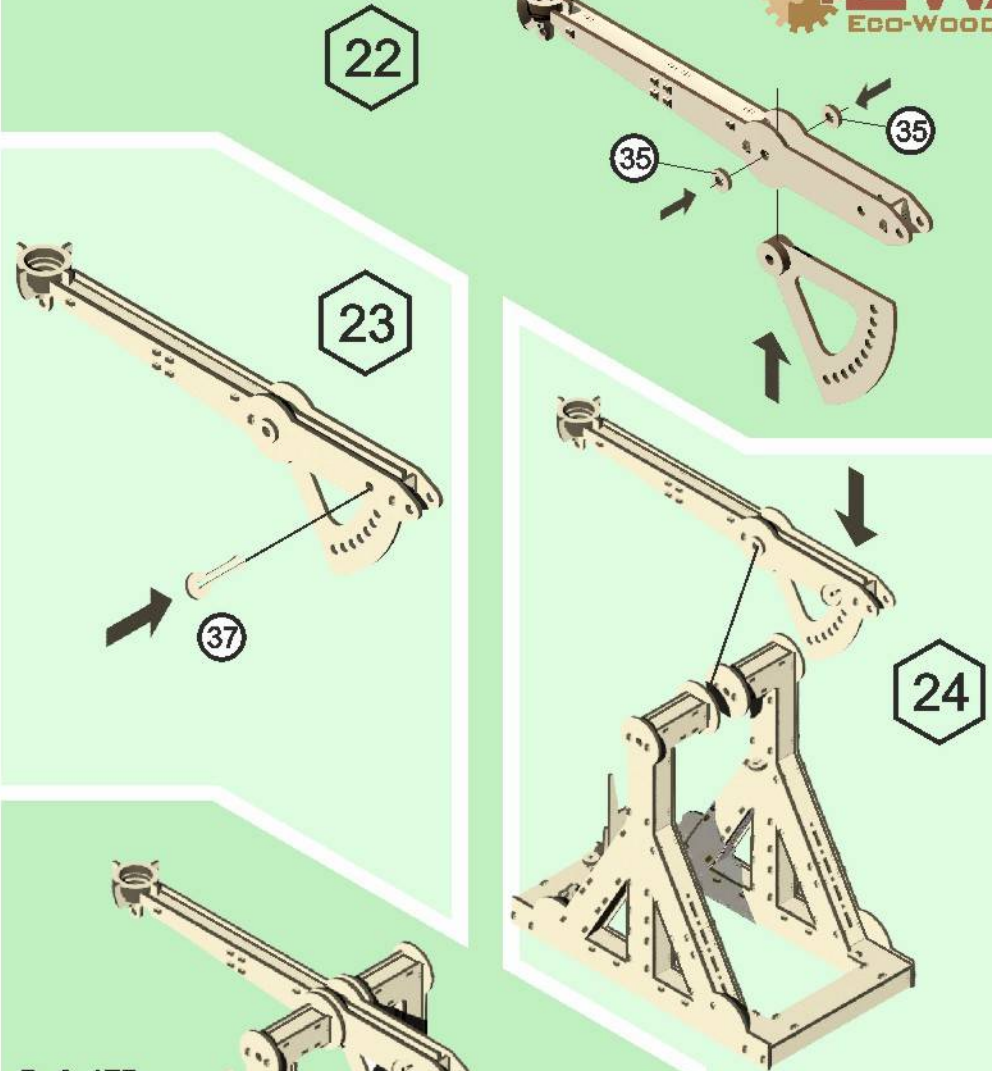
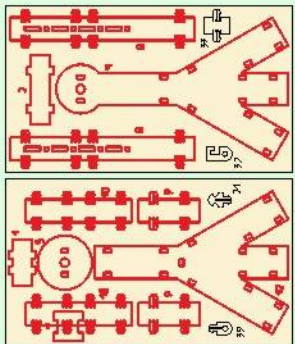
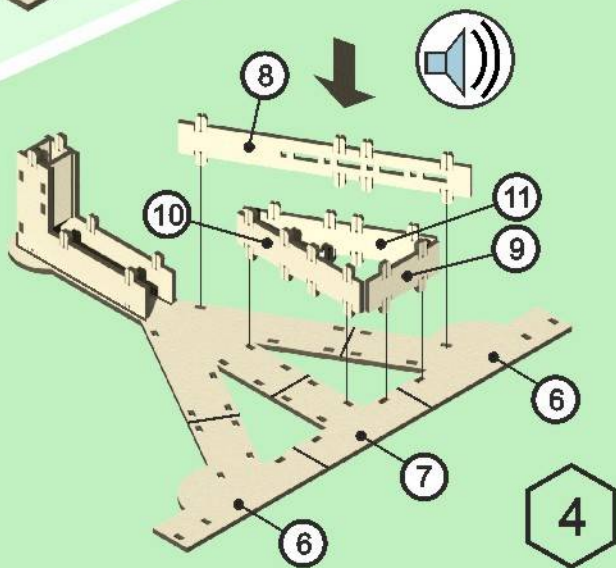
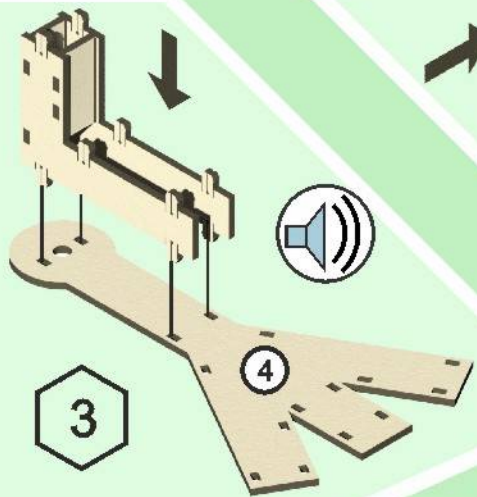
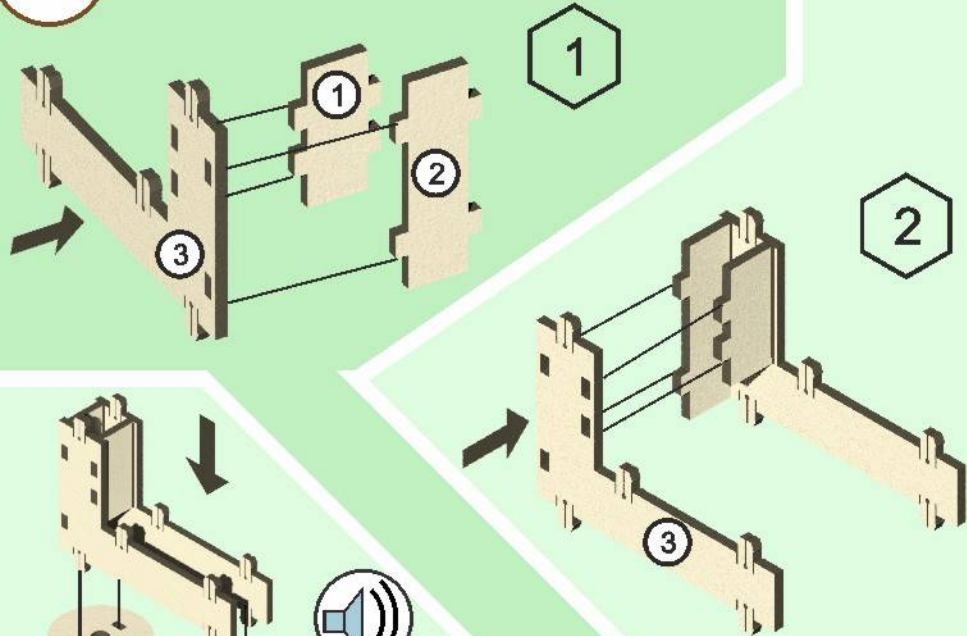

3 Assembly instructions Trebuche

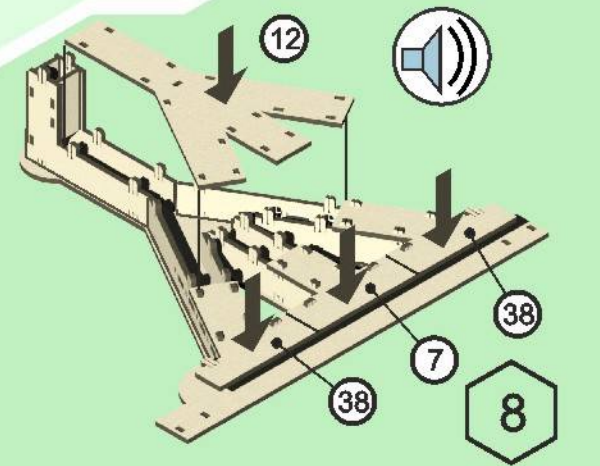
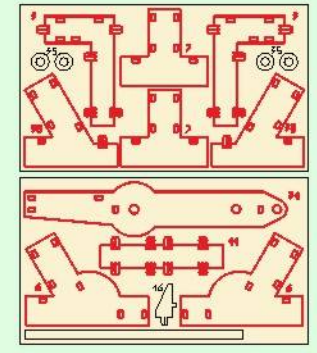
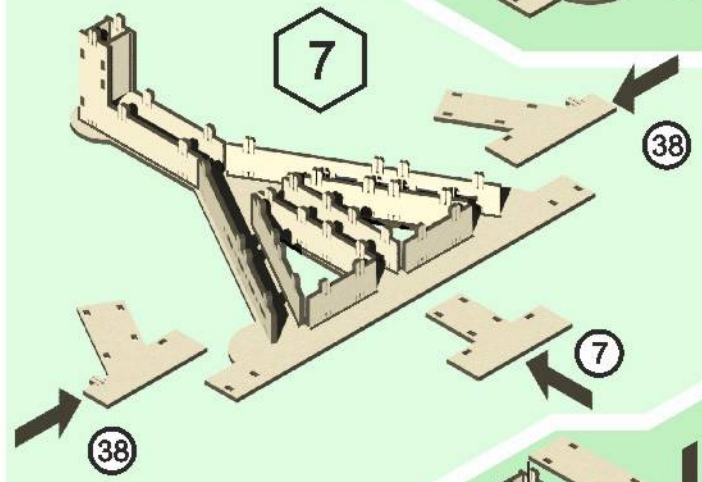
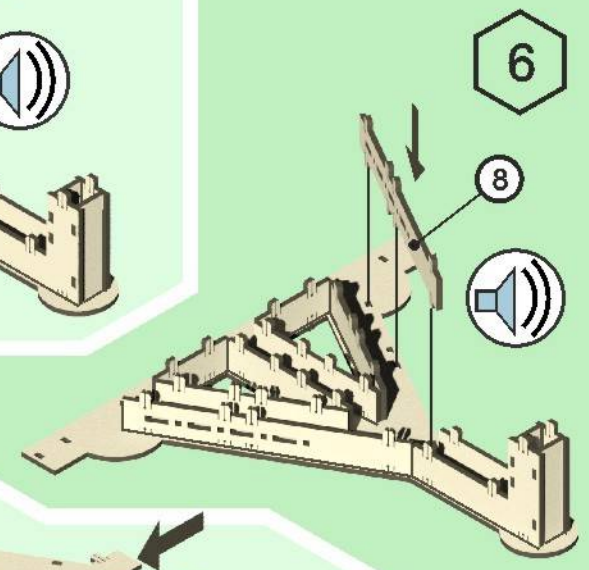
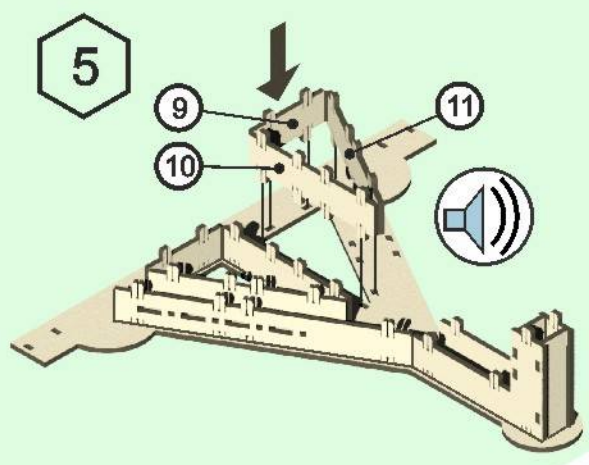
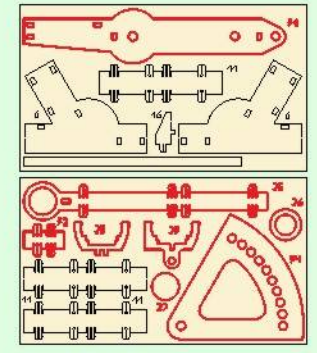
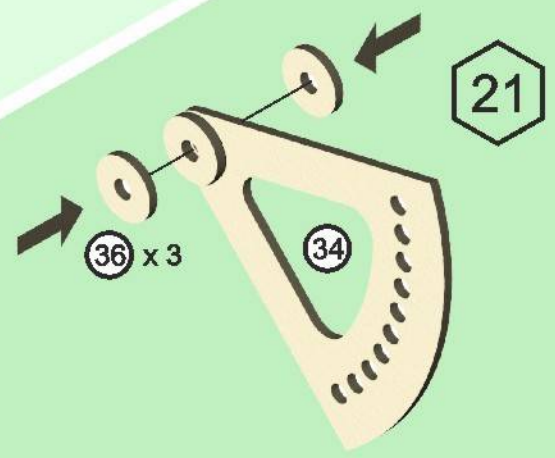
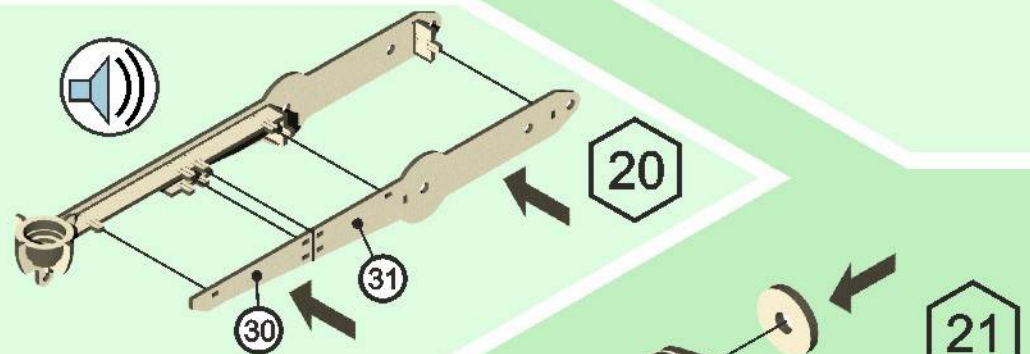
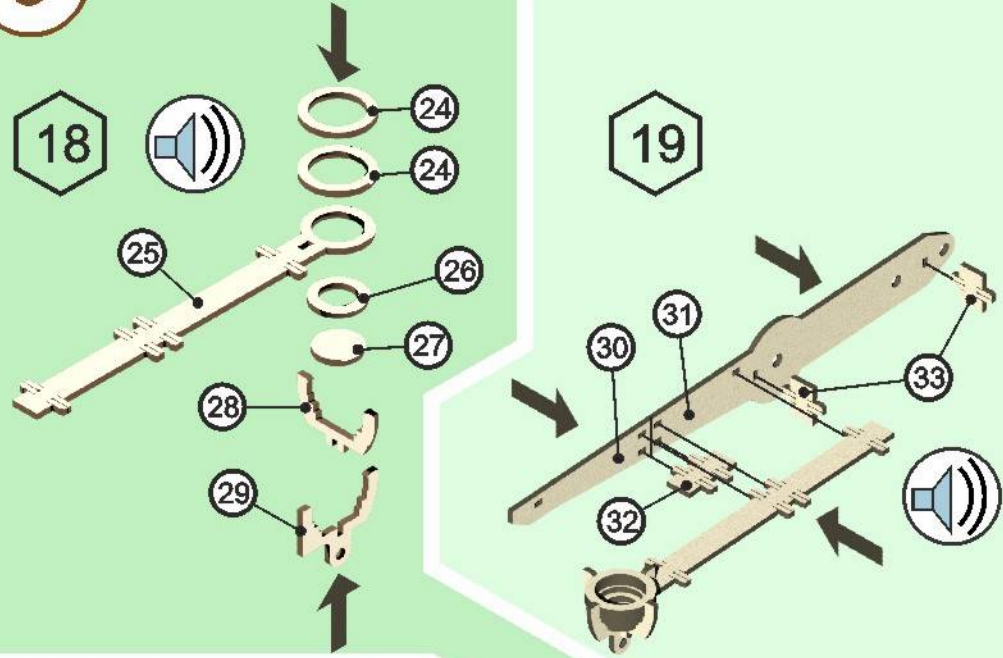

2 Assembly instructions Trebuches

