

Quick Reference Guide

Kurzanleitung

Guide de référence rapide

Beknopte Bedieningshandleiding

Guida di riferimento rapido

Guía de referencia rápida

Guia de referência rápida

Краткий справочник



Be sure to read this document before using the machine.
We recommend that you keep this document nearby for future reference.

Bitte lesen Sie diese Anleitung, bevor Sie mit der Maschine arbeiten.
Es wird empfohlen, diese Anleitung griffbereit aufzubewahren,
damit Sie jederzeit darin nachschlagen können.

Veillez à lire ce document avant d'utiliser la machine.
Nous vous conseillons de conserver ce document à portée de main
pour vous y référer ultérieurement.

Lees dit document voordat u de machine gebruikt.
Houd dit document bij de hand, zodat u het kunt raadplegen.

Leggere questo documento prima di utilizzare la macchina.
Si consiglia di conservare questo documento nelle vicinanze per un
eventuale riferimento futuro.

Lea este documento antes de utilizar la máquina.
Recomendamos que tenga este documento a mano por si necesita
consultarlo más adelante.

Certifique-se de ler este documento antes de utilizar a máquina.
Recomendamos guardar este documento em um lugar de fácil acesso
para futuras referências.

Обязательно прочитайте этот документ перед началом работы на
машине!
Рекомендуется хранить данный документ в удобном месте, чтобы
он был доступен для справок.

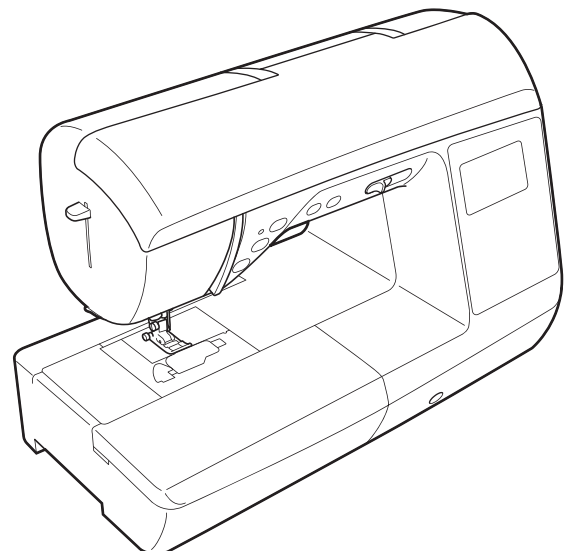
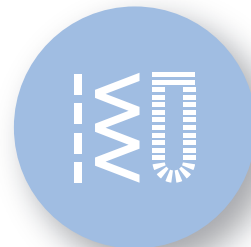

Before using your machine for the first time please read the “IMPORTANT SAFETY INSTRUCTIONS” in the Operation Manual.

Refer to the operation manual for detailed instructions. In this guide, English screens are used for basic explanations.

Avant d'utiliser votre machine pour la première fois, veuillez lire les « INSTRUCTIONS DE SÉCURITÉ IMPORTANTES » indiquées dans le manuel d'instructions.

Reportez-vous au manuel d'instructions pour des informations détaillées. Les écrans de ce guide sont en anglais pour les explications de base.

Prima di utilizzare la macchina per la prima volta, leggere “IMPORTANTI ISTRUZIONI DI SICUREZZA” nel manuale d'istruzione.

Per le istruzioni dettagliate, consultare il manuale di istruzioni. Nella presente guida si utilizzano le schermate in inglese per le spiegazioni di base.

Antes de utilizar a sua máquina pela primeira vez, leia as “INSTRUÇÕES DE SEGURANÇA IMPORTANTES” no Manual de Operações.

Consulte o manual de operações para obter instruções detalhadas.

Neste manual, as telas em inglês são usadas para as explicações básicas.

Bevor Sie die Maschine zum ersten Mal verwenden, lesen Sie bitte „WICHTIGE SICHERHEITSHINWEISE“ in der Bedienungsanleitung.

Ausführliche Hinweise finden Sie in der Bedienungsanleitung. In dieser Anleitung werden für die grundlegenden Erläuterungen englischsprachige Bildschirme verwendet.

Lees – voordat u de machine de eerste keer gebruikt – de “BELANGRIJKE VEILIGHEIDSINSTRUCTIES” in de Bedieningshandleiding.

In de bedieningshandleiding vindt u uitvoerige aanwijzingen. In deze gids worden Engelse schermen gebruikt bij de uitleg van basisbewerkingen.

Antes de utilizar la máquina por primera vez, lea las “INSTRUCCIONES DE SEGURIDAD IMPORTANTES” en el Manual de instrucciones.

Consulte las instrucciones detalladas en el manual de instrucciones.

En esta guía, para las explicaciones básicas se utilizan pantallas en inglés.

Перед первым использованием машины прочитайте раздел “ВАЖНЫЕ ИНСТРУКЦИИ ПО БЕЗОПАСНОСТИ” в Руководстве пользователя.

Подробные инструкции см. в руководстве пользователя.

В данном руководстве в качестве иллюстраций используются англоязычные экраны.

Operation Manual Notations

Descriptions in the Operation Manual are divided into those for Model 1, 2, 3 or 4, depending on the machine specifications. For this sewing machine, refer to descriptions for Model 1.

Anmerkungen in der Bedienungsanleitung

Die Beschreibungen in der Bedienungsanleitung sind entsprechend den technischen Daten einer Maschine für Modell 1, 2, 3 oder 4 aufgeteilt. Für diese Nähmaschine gelten die Beschreibungen für Modell 1.

Remarques concernant le manuel d'instructions

Les descriptions du manuel d'instructions sont réparties entre les modèles 1, 2, 3 et 4, selon les caractéristiques de la machine. Pour cette machine à coudre, reportez-vous aux descriptions du modèle 1.

Opmerkingen Bedieningshandleiding

De beschrijvingen in de Bedieningshandleiding zijn opgesplitst voor de modellen 1, 2, 3 of 4, afhankelijk van de specificaties van de machines. Voor deze naaimachine zijn de beschrijvingen voor model 1 van toepassing.

Note nel manuale d'istruzione

Le descrizioni riportate nel manuale d'istruzione sono divise per modello (Modello 1, 2, 3 o 4), a seconda delle specifiche della macchina. Per questa macchina per cucire, consultare le descrizioni per il Modello 1.

Indicaciones del Manual de instrucciones

Las explicaciones del Manual de instrucciones aparecen divididas en base a los Modelos 1, 2, 3 o 4, dependiendo de las especificaciones de la máquina. Para esta máquina de coser, consulte las descripciones para el Modelo 1.

Notações no Manual de Operações

As descrições no Manual de Operações são divididas em descrições para os Modelos 1, 2, 3 ou 4, dependendo das especificações da máquina. Para esta máquina de costura, consulte as descrições para o Modelo 1.

Обозначения в Руководстве пользователя

Описания в Руководстве пользователя приведены для нескольких моделей машины. Они обозначены как инструкции для модели 1, 2, 3 или 4. К данной швейной машине относятся описания для модели 1.

Contents

Accessories	4
◆ Included Accessories	4
◆ Optional Accessories	4
Bobbin Winding and Setting	12
Upper Threading	14
Name of Machine Parts	16
◆ Operation buttons	16
◆ Operation panel	17
◆ Settings screen	19
Selecting and Sewing Patterns	20
◆ Preset Utility Stitches	20
◆ Utility Stitches	21
◆ Decorative Stitches	22
◆ Character stitches	22
Summary of Stitch Patterns	23
◆ Preset Utility Stitches	23
◆ Utility Stitches	23
◆ Decorative Stitches	23
◆ Character stitches	25

Inhalt

Zubehör	4
◆ Mitgeliefertes Zubehör	4
◆ Optionales Zubehör	4
Aufspulen des Unterfadens und Einstellung	12
Einfädeln des Oberfadens	14
Bezeichnungen der Maschinenteile	16
◆ Funktionstasten	16
◆ Bedienfeld	17
◆ Einstellungsbildschirm	19
Auswählen und Nähen von Stichen	20
◆ Voreingestellte Nutztiche	20
◆ Nutztiche	21
◆ Dekorstiche	22
◆ Buchstabenstiche	22
Stich-Übersicht	23
◆ Voreingestellte Nutztiche	23
◆ Nutztiche	23
◆ Dekorstiche	23
◆ Buchstabenstiche	25

Table des matières

Accessoires	6
◆ Accessoires inclus	6
◆ Accessoires en option	6
Bobinage et réglage de la canette	12
Enfilage supérieur	14
Nom des pièces de la machine	16
◆ Touches de commande	16
◆ Panneau de commande	17
◆ Écran de réglages	19
Sélection et couture de motifs	20
◆ Préréglage des points de couture courants	20
◆ Points de couture courants	21
◆ Points décoratifs	22
◆ Points de caractères	22
Sommaire des motifs de point	23
◆ Préréglage des points de couture courants	23
◆ Points de couture courants	23
◆ Points décoratifs	23
◆ Points de caractères	25

Inhoudsopgave

Accessoires	6
◆ Bijgeleverde accessoires	6
◆ Optionele accessoires	6
Opwinden en instellen van de spoel	12
Inrijgen van de bovendraad	14
Naam van machine-onderdelen	16
◆ Bedieningstoetsen	16
◆ Bedieningspaneel	17
◆ Instellingenschermbild	19
Steken selecteren en naaien	20
◆ Vooraf ingestelde naaisteken	20
◆ Naaisteken	21
◆ Decoratieve steken	22
◆ Lettersteken	22
Steken overzicht	23
◆ Vooraf ingestelde naaisteken	23
◆ Naaisteken	23
◆ Decoratieve steken	23
◆ Lettersteken	25

Sommario

Accessori	8
◆ Accessori in dotazione	8
◆ Accessori opzionali	8
Avvolgimento spolina e caricamento	12
Infilatura superiore	14
Nome delle parti della macchina	16
◆ Pulsanti di funzionamento	16
◆ Pannello operativo	18
◆ Schermata Impostazioni	19
Selezione e cucitura di motivi	20
◆ Punti utili preimpostati	20
◆ Punti utili	21
◆ Punti decorativi	22
◆ Punti a caratteri	22
Sommario degli schemi punto	23
◆ Punti utili preimpostati	23
◆ Punti utili	23
◆ Punti decorativi	23
◆ Punti a caratteri	25

Índice

Acessórios	10
◆ Acessórios incluídos	10
◆ Acessórios opcionais	10
Configuração e enrolamento da bobina	12
Passagem da linha superior	14
Nome das peças da máquina	16
◆ Botões de operação	16
◆ Painel de operação	18
◆ Configurações da tela	19
Seleção e costura de padrões	20
◆ Pontos utilitários predefinidos	20
◆ Pontos utilitários	21
◆ Pontos decorativos	22
◆ Pontos de caracteres	22
Resumo dos padrões de ponto	23
◆ Pontos utilitários predefinidos	23
◆ Pontos utilitários	23
◆ Pontos decorativos	23
◆ Pontos de caracteres	25

Contenido

Accesorios	8
◆ Accesorios incluidos	8
◆ Accesorios opcionales	8
Bobinado y ajuste	12
Hilo superior	14
Nombres de las piezas de la máquina	16
◆ Botones de operación	16
◆ Panel de operaciones	18
◆ Pantalla de ajustes	19
Seleccionar y coser patrones	20
◆ Puntadas de utilidad predefinidas	20
◆ Puntadas de utilidad	21
◆ Puntadas decorativas	22
◆ Puntadas de carácter	22
Resumen de tipos de puntada	23
◆ Puntadas de utilidad predefinidas	23
◆ Puntadas de utilidad	23
◆ Puntadas decorativas	23
◆ Puntadas de carácter	25

Содержание

Принадлежности	10
◆ Принадлежности в комплекте поставки	10
◆ Дополнительные принадлежности	10
Намотка и установка шпульки	12
Заправка верхней нити	14
Наименования частей машины	16
◆ Кнопки управления	16
◆ Панель управления	18
◆ Экран настроек	19
Выбор швейных строчек	20
◆ Предварительно заданные основные строчки	20
◆ Основные строчки	21
◆ Декоративные строчки	22
◆ Символьные строчки	22
Рисунки строчек	23
◆ Предварительно заданные основные строчки	23
◆ Основные строчки	23
◆ Декоративные строчки	23
◆ Символьные строчки	25

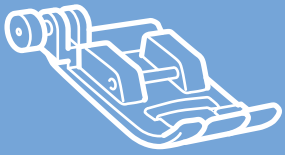

Accessories

Zubehör

◆ Included Accessories ◆ Mitgeliefertes Zubehör

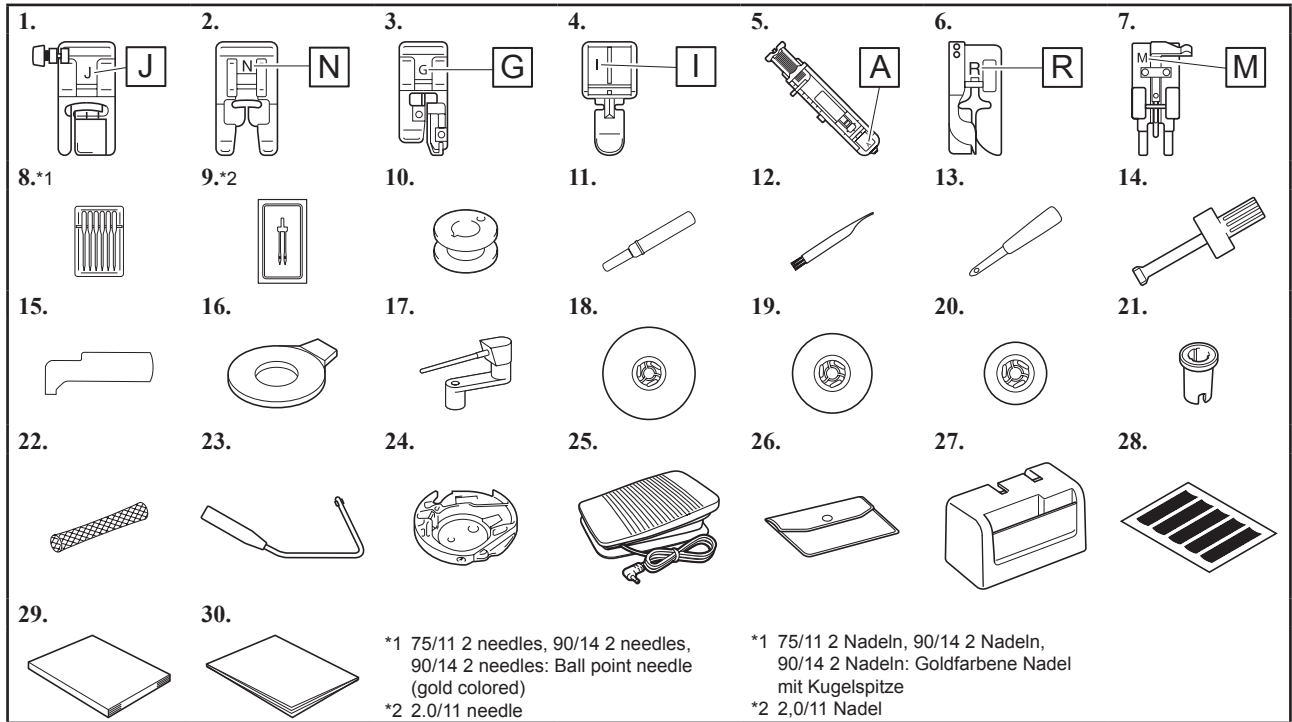

◆ Optional Accessories ◆ Optionales Zubehör

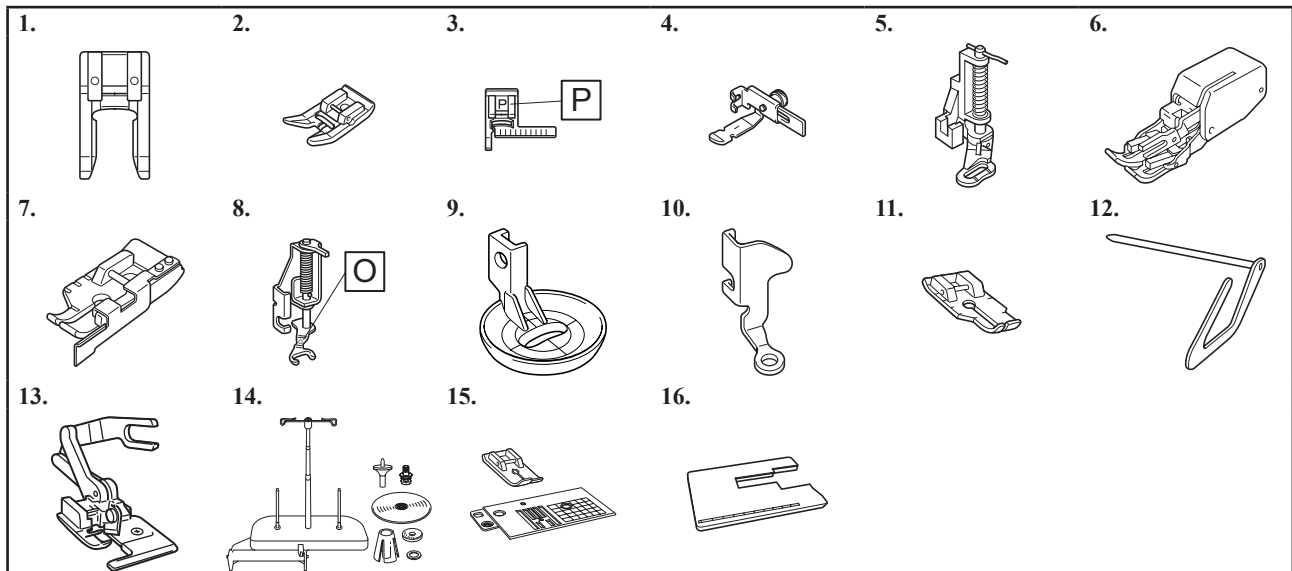

◆ Included Accessories

No.	Part Name	Part Code	
		Americas	Others
1	Zigzag foot "J" (on machine)	XF9671-001	
2	Monogramming foot "N"	XD0810-031	
3	Overcasting foot "G"	XC3098-031	
4	Zipper foot "I"	X59370-021	
5	Buttonhole foot "A"	XC2691-023	
6	Blind stitch foot "R"	XE2650-001	
7	Button fitting foot "M"	XE2643-001	
8	Needle set	X58358-021	
9	Twin needle	X59296-121	
10	Bobbin (4) (One is on machine.)	SA156*3	SFB: XA5539-151
11	Seam ripper	XF4967-001	
12	Cleaning brush	X59476-051	
13	Eyelet punch	XZ5051-001	
14	Screwdriver (large)	XC4237-021	
15	L-shaped screwdriver	XG0918-001	
16	Disc-shaped screwdriver	XC1074-051	
17	Horizontal spool pin	XC4654-151	
18	Spool cap (large)	130012-024	
19	Spool cap (medium) (2) (One is on machine.)	XE1372-001	
20	Spool cap (small)	130013-124	
21	Thread spool insert (mini king thread spool)	XA5752-121	
22	Spool net	XA5523-020	
23	Knee lifter	XA6941-052	
24	Bobbin case (on machine)	XG2058-001	
25	Foot controller	XZ5098-001 (EU area) XZ5100-001 (other areas)	
26	Accessory bag	XC4487-021	
27	Hard case	XF8684-001	
28	Grid sheet set	XC4549-020	
29	Operation manual	Contact your authorized Brother dealer.	
30	Quick reference guide		

*3 SA156 is Class15 type bobbin.

◆ Mitgeliefertes Zubehör

Nr.	Teilebezeichnung	Bestellnummer	
		Nord- und Südamerika	Andere
1	Zickzackfuß „J“ (an der Maschine)	XF9671-001	
2	Nähfuß „N“	XD0810-031	
3	Überwendlingfuß „G“	XC3098-031	
4	Reißverschlussfuß „I“	X59370-021	
5	Knopflochfuß „A“	XC2691-023	
6	Blindstichfuß „R“	XE2650-001	
7	Knopfannähfuß „M“	XE2643-001	
8	Nadelsatz	X58358-021	
9	Zwillingsnadel	X59296-121	
10	Spule (4) (Eine ist in der Maschine.)	SA156*3	SFB: XA5539-151
11	Pfeiltrenner	XF4967-001	
12	Reinigungspinsel	X59476-051	
13	Ahle	XZ5051-001	
14	Schraubendreher (groß)	XC4237-021	
15	L-förmiger Schraubendreher	XG0918-001	
16	Scheibenförmiger Schraubendreher	XC1074-051	
17	Horizontaler Garnrollenstift	XC4654-151	
18	Garnrollenkappe (groß)	130012-024	
19	Garnrollenkappe (mittel) (2) (Eine ist in der Maschine.)	XE1372-001	
20	Garnrollenkappe (klein)	130013-124	
21	Garnrolleneinsatz (Mini-King-Garnrolle)	XA5752-121	
22	Spulennetz	XA5523-020	
23	Kniehebel	XA6941-052	
24	Spulenkapsel (in der Maschine)	XG2058-001	
25	Fußpedal	XZ5098-001 (EU-Zone) XZ5100-001 (andere Zonen)	
26	Zubehörtasche	XC4487-021	
27	Tragekoffer	XF8684-001	
28	Schabloneinsatz	XC4549-020	
29	Bedienungsanleitung	Wenden Sie sich an Ihr Brother-Fachgeschäft.	
30	Kurzanleitung		

*3 SA156 ist eine Class15-Spule.

◆ Optional Accessories

The following are available as optional accessories to be purchased separately from your authorized Brother dealer.

No.	Part Name	Part Code	
		Americas	Others
1	Open toe foot	SA186	F060: XE1094-101
2	Non stick foot	SA114	F007N: XC1949-052
3	Stitch guide foot "P"	SA160	F035N: XC1969-052
4	Adjustable zipper/piping foot	SA161	F036N: XC1970-052
5	Quilting foot	SA129	F005N: XC1948-052
6	Walking foot	SA140	F033N: XC2214-052
7	1/4" quilting foot with guide	SA185	F057: XC7416-252
8	Free motion open toe quilting foot "O"	SA187	F061: XE1097-001
9	Free motion echo quilting foot "E"	XE0766-001	
10	Free motion quilting foot "C"	XE0765-101	
11	1/4" quilting foot	SA125	F001N: XC1944-052
12	Quilting guide	SA132	F016N: XC2215-052
13	Side cutter "S"	SA177	F054: XC3879-152
14	Spool stand	SA563 (U.S.A.) SA563C (Canada)	TS7: XG0900-001 TS7AP: XG0902-001
15	Straight stitch foot and needle plate set	SA564 (U.S.A.) SA564C (Canada)	SNP02: XG0946-001 SNP02AP: XG0948-001
16	Wide table	SAWTNQ1 (U.S.A.) SAWTNQ1C (Canada)	WT12: XG0955-001 WT12AP: XG0956-001

◆ Optionales Zubehör

Folgendes Sonderzubehör ist separat bei Ihrem Brother-Vertragshändler erhältlich.

Nr.	Teilebezeichnung	Bestellnummer	
		Nord- und Südamerika	Andere
1	Applikationsfuß	SA186	F060: XE1094-101
2	Antihafffuß	SA114	F007N: XC1949-052
3	Stichführungsfuß „P“	SA160	F035N: XC1969-052
4	Einstellbarer Reißverschluss/ Kordelfuß	SA161	F036N: XC1970-052
5	Quiltfuß	SA129	F005N: XC1948-052
6	Stoffobertransport	SA140	F033N: XC2214-052
7	1/4-Zoll-Quiltfuß mit Führung	SA185	F057: XC7416-252
8	Offener Nähfuß „O“ zum Freihand- Quilten	SA187	F061: XE1097-001
9	Freihand-Echoquiltfuß „E“	XE0766-001	
10	Quiltfuß „C“ zum Freihand-Quilten	XE0765-101	
11	1/4-Zoll-Quiltfuß	SA125	F001N: XC1944-052
12	Quilt-Führung	SA132	F016N: XC2215-052
13	Kantenabschneider „S“	SA177	F054: XC3879-152
14	Garnrollenständer	SA563 (USA) SA563C (Kanada)	TS7: XG0900-001 TS7AP: XG0902-001
15	Geradstichfuß und Stichplattensatz	SA564 (USA) SA564C (Kanada)	SNP02: XG0946-001 SNP02AP: XG0948-001
16	Maxi-Anschiebetisch	SAWTNQ1 (USA) SAWTNQ1C (Kanada)	WT12: XG0955-001 WT12AP: XG0956-001

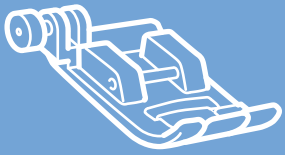

Accessoires

Accessoires

◆ Accessoires inclus

◆ Bijgeleverde accessoires

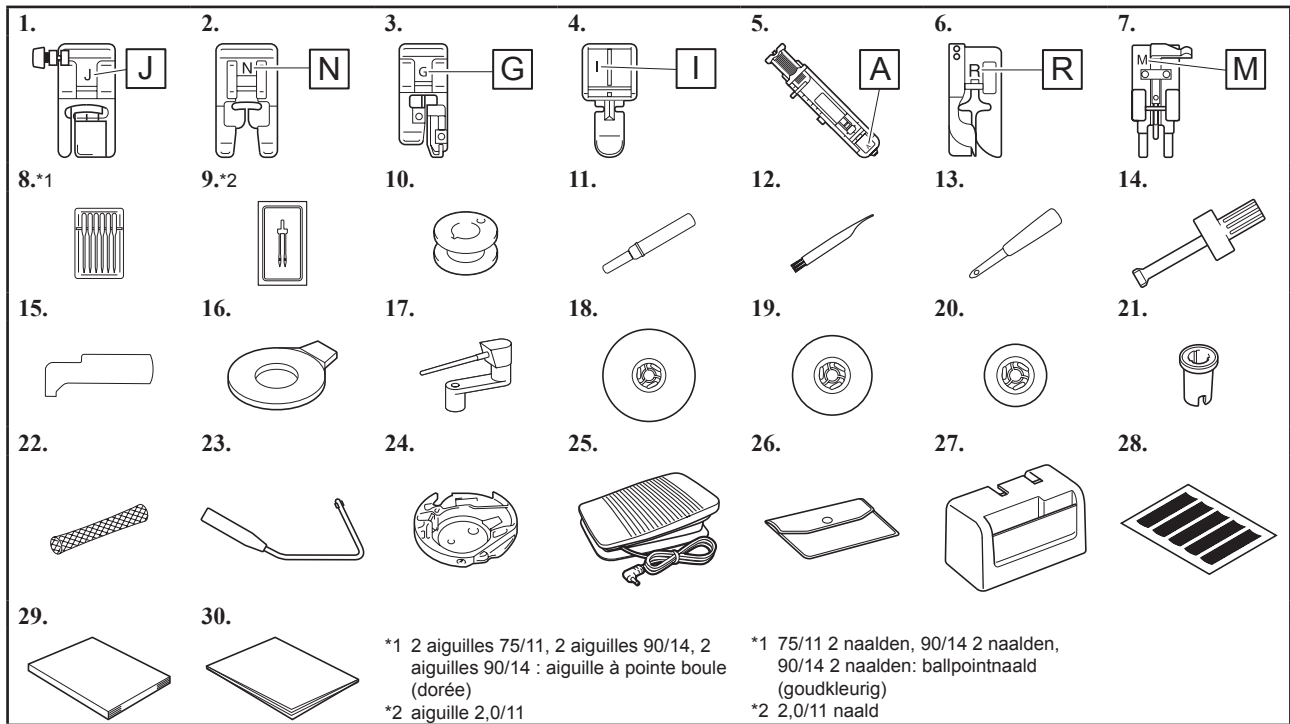

◆ Accessoires en option

◆ Optionele accessoires

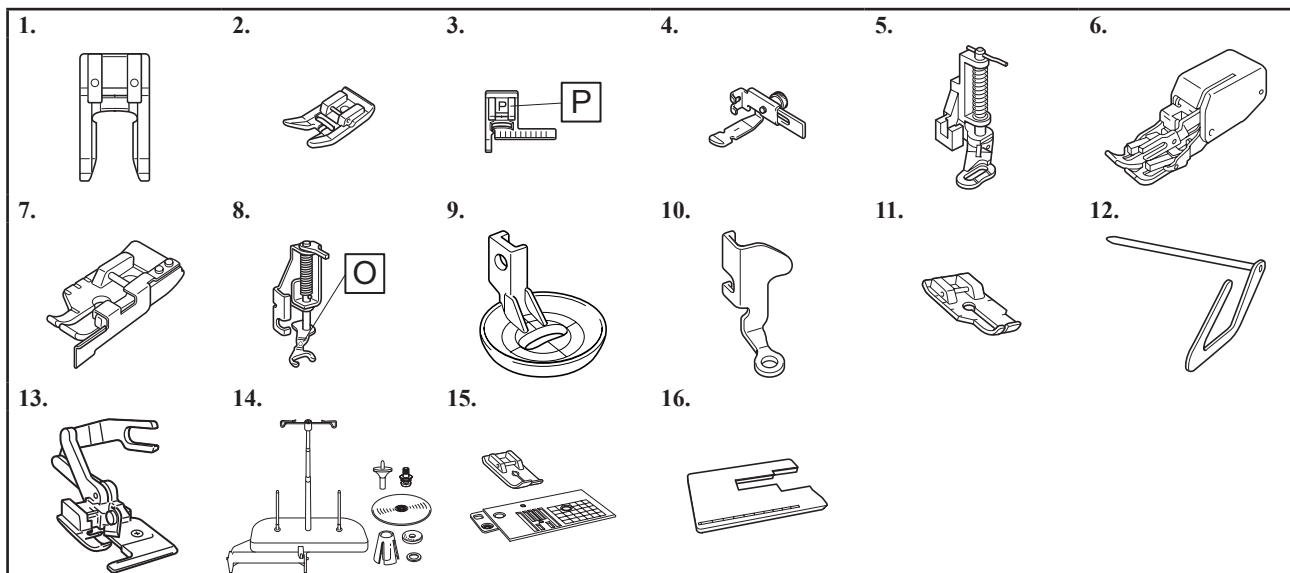

◆ Accessoires inclus

N°	Nom de la pièce	Code de la pièce	
		Continent américain	Autres
1	Pied zigzag « J » (sur la machine)		XF9671-001
2	Pied pour monogrammes « N »		XD0810-031
3	Pied pour faufilage « G »		XC3098-031
4	Pied pour fermetures à glissière « I »		X59370-021
5	Pied pour boutons « A »		XC2691-023
6	Pied pour point invisible « R »		XE2650-001
7	Pied pour boutons « M »		XE2643-001
8	Jeu d'aiguilles		X58358-021
9	Aiguille jumelée		X59296-121
10	Canette x 4 (l'une se trouve sur la machine.)	SA156*3	SFB: XA5539-151
11	Découpeur		XF4967-001
12	Brosse de nettoyage		X59476-051
13	Perce-œillet		XZ5051-001
14	Tournevis (grand)		XC4237-021
15	Tournevis en forme de L		XG0918-001
16	Tournevis en forme de disque		XC1074-051
17	Porte-bobine horizontal		XC4654-151
18	Couvercle de bobine (grand)		130012-024
19	Couvercle de bobine (moyen) x 2 (l'un se trouve sur la machine.)		XE1372-001
20	Couvercle de bobine (petit)		130013-124
21	Centre amovible pour bobine de fil (bobine de fil mini/très grand)		XA5752-121
22	Filet de la bobine		XA5523-020
23	Genouillère		XA6941-052
24	Boîtier de la canette (sur la machine)		XG2058-001
25	Pédale	XZ5098-001 (zone UE) XZ5100-001 (autres zones)	
26	Sac d'accessoires		XC4487-021
27	Protection rigide		XF8684-001
28	Ensemble de feuilles quadrillées		XC4549-020
29	Manuel d'instructions	Contactez votre revendeur	
30	Guide de référence rapide	Brother agréé.	

*3 SA156 est une canette de catégorie 15.

◆ Bijgeleverde accessoires

Nr.	Onderdeel	Onderdeelcode	
		Het Amerikaanse continent	Overige regio's
1	Zigzagvoet "J" (op machine)		XF9671-001
2	Monogramvoet "N"		XD0810-031
3	Afwerksteekvoet "G"		XC3098-031
4	Ritsvoet "I"		X59370-021
5	Knoopsgatvoet "A"		XC2691-023
6	Blindzoomvoet "R"		XE2650-001
7	Knoopaanzetvoet "M"		XE2643-001
8	Naaldsetje		X58358-021
9	Tweelingnaald		X59296-121
10	Spoel x 4 (één spoel is in de machine geplaatst.)	SA156*3	SFB: XA5539-151
11	Tornmesje		XF4967-001
12	Schoonmaakborsteltje		X59476-051
13	Gaatjesponser		XZ5051-001
14	Schroevendraaier (groot)		XC4237-021
15	L-vormige schroevendraaier		XG0918-001
16	Schijfvormige schroevendraaier		XC1074-051
17	Horizontale klospen		XC4654-151
18	Kloshouder (groot)		130012-024
19	Kloshouder (medium) x 2 (één kloshouder is op de machine geplaatst.)		XE1372-001
20	Kloshouder (klein)		130013-124
21	Garenklos hulpinzet (bij mini- of kingsize garenklos)		XA5752-121
22	Klosnetje		XA5523-020
23	Kniehevel		XA6941-052
24	Spoelhuis (in de machine)		XG2058-001
25	Voetpedaal	XZ5098-001 (EU) XZ5100-001 (andere regio's)	
26	Accessoires tasje		XC4487-021
27	Koffer		XF8684-001
28	Rasterzet		XC4549-020
29	Bedieningshandleiding	Neem contact op met uw erkende Brother-dealer.	
30	Beknopte bedieningshandleiding		

*3 SA156 is een spoeltype van klasse 15.

◆ Accessoires en option

Les éléments suivants sont des accessoires en option vendus séparément par votre revendeur Brother agréé.

N°	Nom de la pièce	Code de la pièce	
		Continent américain	Autres
1	Pied ouvert	SA186	F060: XE1094-101
2	Pied-de-biche non adhérent	SA114	F007N: XC1949-052
3	Pied-de-biche de guidage de points « P »	SA160	F035N: XC1969-052
4	Pied réglable pour fermetures à glissière/passepoils	SA161	F036N: XC1970-052
5	Pied pour quilting (courtepointe)	SA129	F005N: XC1948-052
6	Pied à double entraînement	SA140	F033N: XC2214-052
7	Guide et pied pour quilting (courtepointe) 1/4" / pouce	SA185	F057: XC7416-252
8	Pied pour quilting (courtepointe) ouvert en mouvement libre « O »	SA187	F061: XE1097-001
9	Pied pour quilting (courtepointe) en écho en mouvement libre « E »	XE0766-001	
10	Pied pour quilting (courtepointe) en mouvement libre « C »	XE0765-101	
11	Pied pour quilting (courtepointe) 1/4" / pouce	SA125	F001N: XC1944-052
12	Guide pour quilting (courtepointe)	SA132	F016N: XC2215-052
13	Couteau raseur « S »	SA177	F054: XC3879-152
14	Porte multi-bobines	SA563 (États-Unis) SA563C (Canada)	TS7: XG0900-001 TS7AP: XG0902-001
15	Ensemble pied pour point droit et plaque à aiguille	SA564 (États-Unis) SA564C (Canada)	SNP02: XG0946-001 SNP02AP: XG0948-001
16	Grande table d'extension	SAWTNQ1 (États-Unis) SAWTNQ1C (Canada)	WT12: XG0955-001 WT12AP: XG0956-001

◆ Optionele accessoires

Optionele accessoires, apart verkrijgbaar bij uw officiële Brother dealer.

Nr.	Onderdeel	Onderdeelcode	
		Het Amerikaanse continent	Overige regio's
1	Open voet	SA186	F060: XE1094-101
2	Gladde transportvoet	SA114	F007N: XC1949-052
3	Steekgeleidervoet "P"	SA160	F035N: XC1969-052
4	Verstelbare ritsvoet / paspelvoet	SA161	F036N: XC1970-052
5	Quiltvoet	SA129	F005N: XC1948-052
6	Boventransportvoet	SA140	F033N: XC2214-052
7	1/4-inch quiltvoet met geleider	SA185	F057: XC7416-252
8	Open quiltvoet "O" voor quilten uit de vrije hand	SA187	F061: XE1097-001
9	Quiltvoet "E" voor naaien uit de vrije hand	XE0766-001	
10	Quiltvoet "C" voor naaien uit de vrije hand	XE0765-101	
11	1/4-inch quiltvoet	SA125	F001N: XC1944-052
12	Quiltgeleider	SA132	F016N: XC2215-052
13	Zijsnijder "S"	SA177	F054: XC3879-152
14	Klossenstandaard	SA563 (VS) SA563C (Canada)	TS7: XG0900-001 TS7AP: XG0902-001
15	Rechte-steekvoet en naaldplaatset	SA564 (VS) SA564C (Canada)	SNP02: XG0946-001 SNP02AP: XG0948-001
16	Groot werkblad	SAWTNQ1 (VS) SAWTNQ1C (Canada)	WT12: XG0955-001 WT12AP: XG0956-001

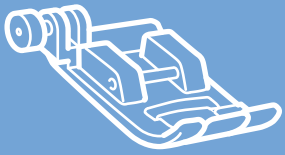

Accessori

Accesorios

◆ Accessori in dotazione

◆ Accesorios incluidos

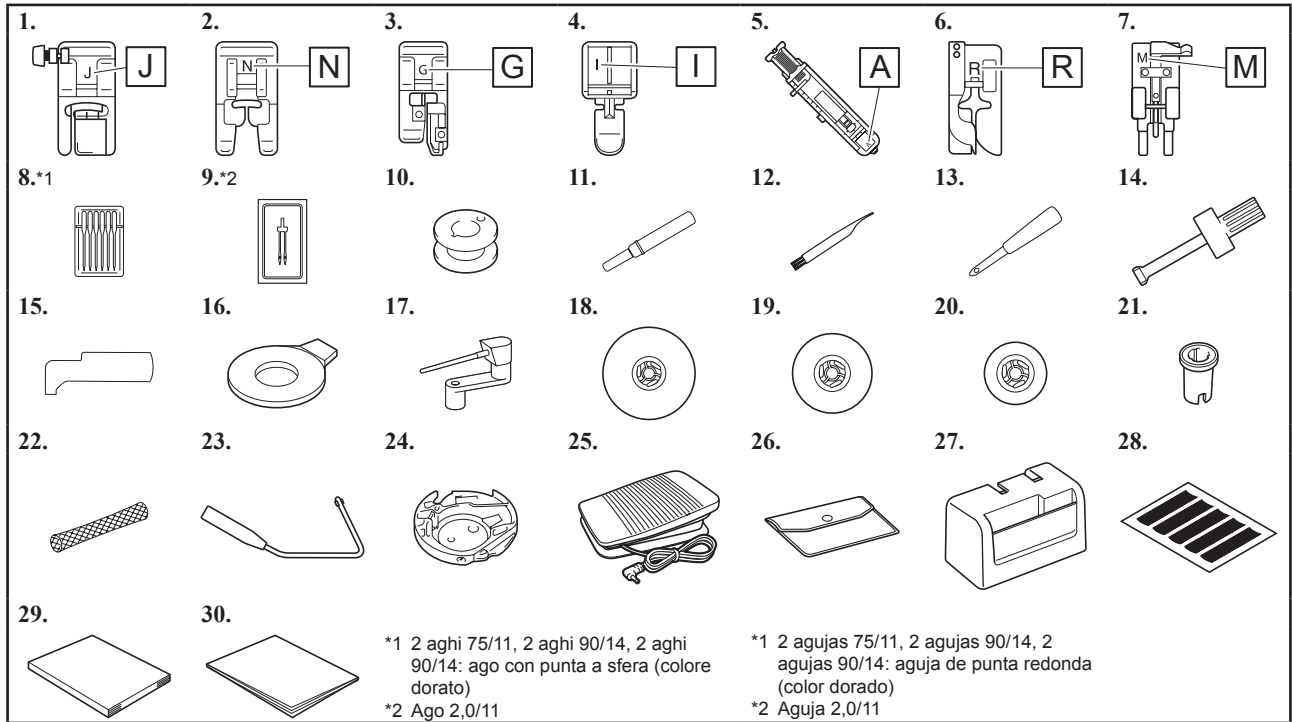

◆ Accessori opzionali

◆ Accesorios opcionales

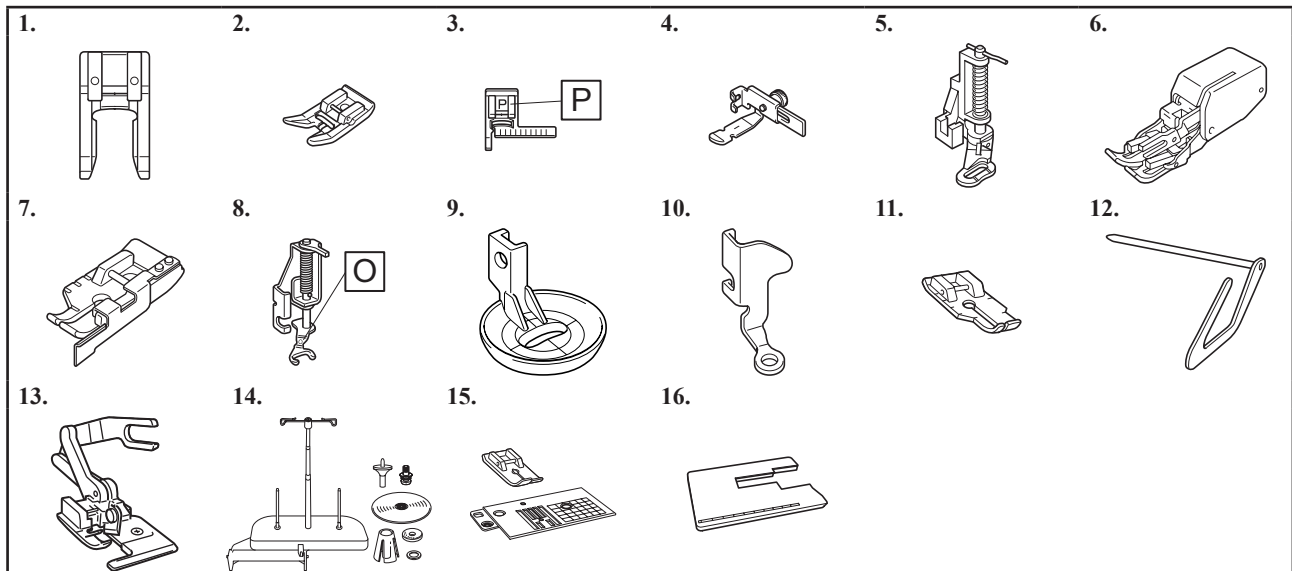

◆ Accessori in dotazione

N°	Nome parte	Codice parte	
		Americhe	Varie
1	Piedino per zig-zag "J" (sulla macchina)	XF9671-001	
2	Piedino per monogrammi "N"	XD0810-031	
3	Piedino per soprappiglio "G"	XC3098-031	
4	Piedino per cerniere "I"	X59370-021	
5	Piedino per asole "A"	XC2691-023	
6	Piedino per punto invisibile "R"	XE2650-001	
7	Piedino di cucitura bottone "M"	XE2643-001	
8	Set di aghi	X58358-021	
9	Ago gemello	X59296-121	
10	Spolina (4) (una è sulla macchina.)	SA156*3	SFB: XA5539-151
11	Taglia asole	XF4967-001	
12	Spazzolino di pulizia	X59476-051	
13	Punzone per occhielli	XZ5051-001	
14	Cacciavite (grande)	XC4237-021	
15	Cacciavite a L	XG0918-001	
16	Cacciavite a disco	XC1074-051	
17	Portarocchetto orizzontale	XC4654-151	
18	Fermo per rocchetto (grande)	130012-024	
19	Fermo per rocchetto (medio) (2) (uno è sulla macchina.)	XE1372-001	
20	Fermo per rocchetto (piccolo)	130013-124	
21	Inserto per rocchetto di filo (rocchetto di filo mini-extra large)	XA5752-121	
22	Retina	XA5523-020	
23	Ginocchiera alzapiedino	XA6941-052	
24	Custodia della spolina (sulla macchina)	XG2058-001	
25	Pedale reostato	XZ5098-001 (area UE) XZ5100-001 (altre aree)	
26	Borsa accessori	XC4487-021	
27	Custodia rigida	XF8684-001	
28	Set di fogli millimetrati	XC4549-020	
29	Manuale d'istruzione	Contattare il proprio rivenditore Brother autorizzato.	
30	Guida di riferimento rapido	Contattare il proprio rivenditore Brother autorizzato.	

*3 SA156 è una spolina del tipo Classe 15.

◆ Accesorios incluidos

N°	Nombre de la pieza	Código de la pieza	
		América	Otros
1	Pie para zig-zag "J" (en la máquina)	XF9671-001	
2	Pie para monogramas "N"	XD0810-031	
3	Pie para sobrehilado "G"	XC3098-031	
4	Pie para cremalleras "I"	X59370-021	
5	Pie para ojales "A"	XC2691-023	
6	Pie para puntada invisible "R"	XE2650-001	
7	Pie especial para botones "M"	XE2643-001	
8	Juego de agujas	X58358-021	
9	Aguja gemela	X59296-121	
10	Bobina (4) (Una está colocada en la máquina.)	SA156*3	SFB: XA5539-151
11	Abreojales	XF4967-001	
12	Cepillo de limpieza	X59476-051	
13	Lápiz calador	XZ5051-001	
14	Destornillador (grande)	XC4237-021	
15	Destornillador en forma de L	XG0918-001	
16	Destornillador de disco	XC1074-051	
17	Portacarrete horizontal	XC4654-151	
18	Tapa del carrete (grande)	130012-024	
19	Tapa del carrete (mediana) (2) (Una está colocada en la máquina.)	XE1372-001	
20	Tapa de carrete (pequeña)	130013-124	
21	Inserción del carrete de hilo (carrete de hilo "mini king")	XA5752-121	
22	Red para carrete	XA5523-020	
23	Elevador de rodilla	XA6941-052	
24	Caja de la bobina (en la máquina)	XG2058-001	
25	Pedal	XZ5098-001 (zona de la UE) XZ5100-001 (otras zonas)	
26	Bolsa de accesorios	XC4487-021	
27	Estuche protector	XF8684-001	
28	Juego de hojas cuadrículadas	XC4549-020	
29	Manual de instrucciones	Póngase en contacto con su distribuidor Brother autorizado.	
30	Guía de referencia rápida	Póngase en contacto con su distribuidor Brother autorizado.	

*3 SA156 Es de bobina clase tipo 15.

◆ Accessori opzionali

Di seguito si elencano i componenti disponibili come accessori opzionali da acquistare separatamente presso il proprio rivenditore Brother autorizzato.

N°	Nome parte	Codice parte	
		Americhe	Varie
1	Piedino a punta aperta	SA186	F060: XE1094-101
2	Piedino antiaderente	SA114	F007N: XC1949-052
3	Piedino guida punto "P"	SA160	F035N: XC1969-052
4	Piedino regolabile per cerniere/cordoncino	SA161	F036N: XC1970-052
5	Piedino per trapuntatura	SA129	F005N: XC1948-052
6	Piedino doppio trasporto	SA140	F033N: XC2214-052
7	Piedino per trapuntatura da 1/4" con guida	SA185	F057: XC7416-252
8	Piedino a punta aperta per trapuntatura a mano libera "O"	SA187	F061: XE1097-001
9	Piedino per trapuntatura a eco a mano libera "E"	XE0766-001	
10	Piedino per trapuntatura a mano libera "C"	XE0765-101	
11	Piedino per trapuntatura da 1/4"	SA125	F001N: XC1944-052
12	Guida per trapuntatura	SA132	F016N: XC2215-052
13	Taglierina laterale "S"	SA177	F054: XC3879-152
14	Supporto per coni di filato	SA563 (Stati Uniti) SA563C (Canada)	TS7: XG0900-001 TS7AP: XG0902-001
15	Set piedino e placca ago per punto diritto	SA564 (Stati Uniti) SA564C (Canada)	SNP02: XG0946-001 SNP02AP: XG0948-001
16	Tavolo ampio	SAWTNQ1 (Stati Uniti) SAWTNQ1C (Canada)	WT12: XG0955-001 WT12AP: XG0956-001

◆ Accesorios opcionales

En la tabla siguiente se presentan los accesorios opcionales disponibles que pueden adquirirse por separado en un distribuidor de Brother autorizado.

N°	Nombre de la pieza	Código de la pieza	
		América	Otros
1	Pie de punta abierta	SA186	F060: XE1094-101
2	Pie antiaderente	SA114	F007N: XC1949-052
3	Pie para guía de puntadas "P"	SA160	F035N: XC1969-052
4	Pie ajustable para cremalleras/ribetes	SA161	F036N: XC1970-052
5	Pie para acolchados	SA129	F005N: XC1948-052
6	Pie móvil	SA140	F033N: XC2214-052
7	Pie para acolchado de 1/4" con guía	SA185	F057: XC7416-252
8	Pie para acolchado libre de punta abierta "O"	SA187	F061: XE1097-001
9	Pie para acolchado repetido libre "E"	XE0766-001	
10	Pie para acolchado libre "C"	XE0765-101	
11	Pie para acolchado de 1/4"	SA125	F001N: XC1944-052
12	Guía de acolchados	SA132	F016N: XC2215-052
13	Cuchilla lateral "S"	SA177	F054: XC3879-152
14	Pora hilos grande	SA563 (EE.UU.) SA563C (Canada)	TS7: XG0900-001 TS7AP: XG0902-001
15	Pie de costura recta y juego de placas de la aguja	SA564 (EE.UU.) SA564C (Canada)	SNP02: XG0946-001 SNP02AP: XG0948-001
16	Tabla ancha	SAWTNQ1 (EE.UU.) SAWTNQ1C (Canada)	WT12: XG0955-001 WT12AP: XG0956-001

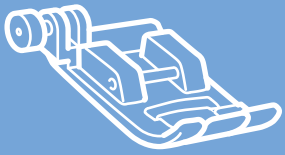

Acessórios

Принадлежности

◆ Acessórios incluídos ◆ Принадлежности в комплекте поставки

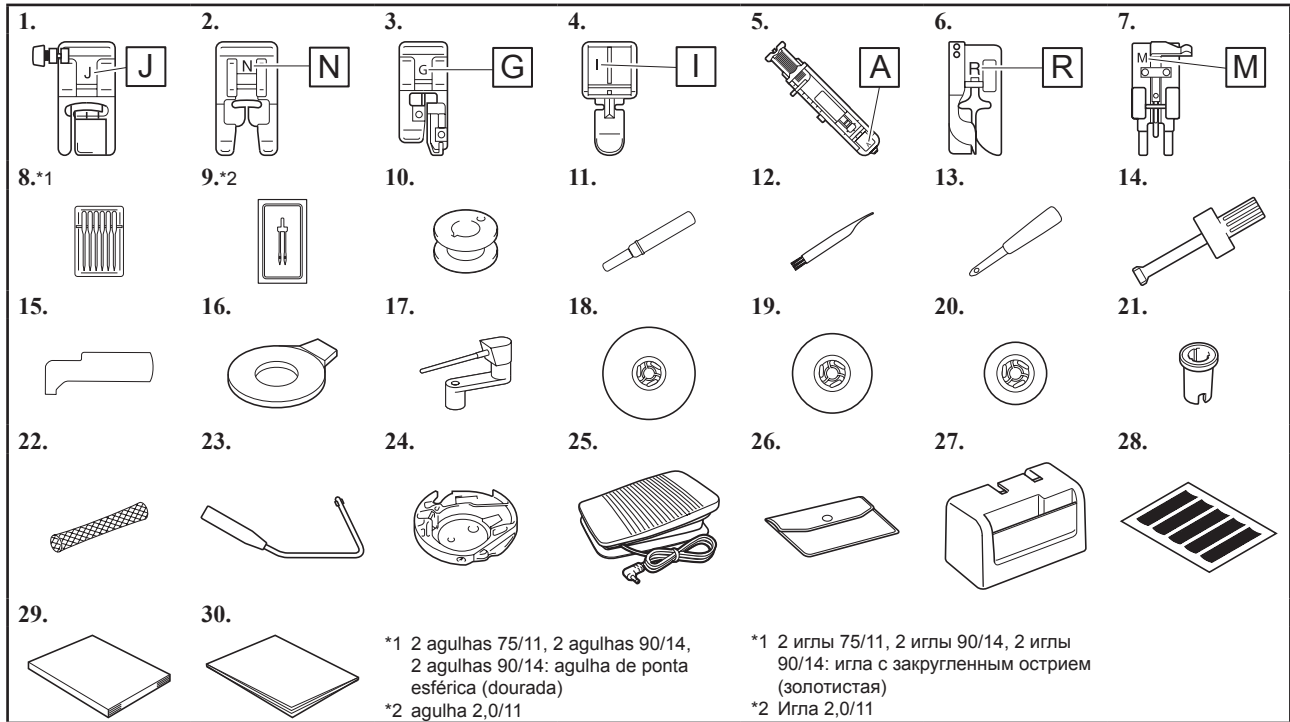

◆ Acessórios opcionais ◆ Дополнительные принадлежности

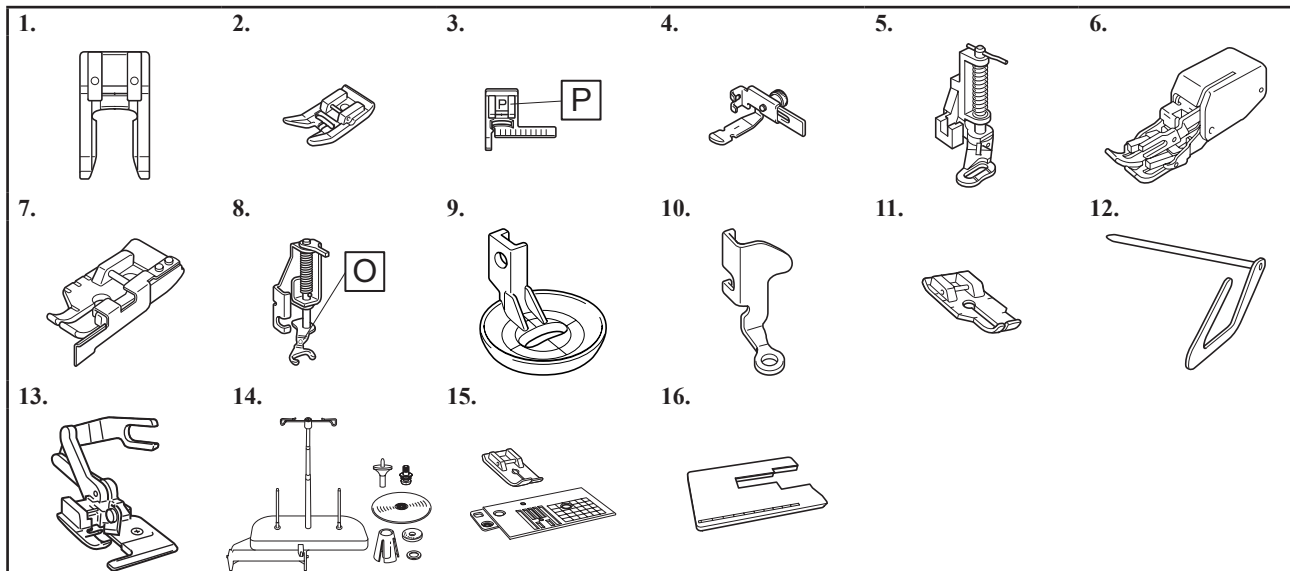

◆ Acessórios incluídos

N°	Nome da peça	Código da peça	
		Américas	Outros
1	Calçador de zigue-zague "J" (na máquina)	XF9671-001	
2	Calçador de monograma "N"	XD0810-031	
3	Calçador de chuleado "G"	XC3098-031	
4	Calçador de zíper "I"	X59370-021	
5	Calçador de casear botão "A"	XC2691-023	
6	Calçador de ponto invisível "R"	XE2650-001	
7	Calçador de pregar de botão "M"	XE2643-001	
8	Conjunto de agulhas	X58358-021	
9	Agulha dupla	X59296-121	
10	Bobina (4) (Uma está na máquina.)	SA156*3	SFB: XA5539-151
11	Abridor de costura	XF4967-001	
12	Escova de limpeza	X59476-051	
13	Perfurador de ilhó	XZ5051-001	
14	Chave de fenda (grande)	XC4237-021	
15	Chave de fenda em forma de L	XG0918-001	
16	Chave de fenda em forma de disco	XC1074-051	
17	Porta-carretel horizontal	XC4654-151	
18	Tampa do carretel (grande)	130012-024	
19	Tampa do carretel (média) (2) (Uma está na máquina.)	XE1372-001	
20	Tampa do carretel (pequena)	130013-124	
21	Inserto do carretel (minicarretel principal)	XA5752-121	
22	Redinha do carretel	XA5523-020	
23	Joelheira	XA6941-052	
24	Caixa da bobina (na máquina)	XG2058-001	
25	Pedal	XZ5098-001 (Região da UE) XZ5100-001 (outras regiões)	
26	Bolsa de acessórios	XC4487-021	
27	Estojo rígido	XF8684-001	
28	Conjunto de folhas de gabarito	XC4549-020	
29	Manual de operações	Entre em contato com o seu revendedor autorizado Brother.	
30	Guia de referência rápida		

*3 SA156 é um tipo de bobina da classe 15.

◆ Принадлежности в комплекте поставки

№	Наименование	Код изделия	
		Америка	Другие
1	Лапка для строчки зигзаг "J" (установлена на машине)	XF9671-001	
2	Лапка для выстрачивания монограмм "N"	XD0810-031	
3	Лапка для краеобметочных работ "G"	XC3098-031	
4	Лапка для вшивания "молнии" "I"	X59370-021	
5	Лапка для обметывания петель "A"	XC2691-023	
6	Лапка для потайной строчки "R"	XE2650-001	
7	Лапка для пришивания пуговиц "M"	XE2643-001	
8	Набор игл	X58358-021	
9	Двойная игла	X59296-121	
10	Шпульки (4 шт., одна из них установлена на машине.)	SA156*3	SFB: XA5539-151
11	Вспарыватель для петель	XF4967-001	
12	Щеточка для очистки	X59476-051	
13	Прошивка	XZ5051-001	
14	Отвертка (большая)	XC4237-021	
15	Г-образная отвертка	XG0918-001	
16	Дискообразная отвертка	XC1074-051	
17	Горизонтальный стержень для установки катушки	XC4654-151	
18	Колпачок катушки (большой)	130012-024	
19	Колпачок катушки (средний) (2 шт., один из них установлен на машине.)	XE1372-001	
20	Колпачок катушки (малый)	130013-124	
21	Вставка для катушки с нитью (катушки Mini-King)	XA5752-121	
22	Сетка для катушки	XA5523-020	
23	Коленоподъемник	XA6941-052	
24	Шпунный колпачок (установлен на машине)	XG2058-001	
25	Педаль	XZ5098-001 (для ЕС), XZ5100-001 (другие регионы)	
26	Сумка для принадлежностей	XC4487-021	
27	Жесткий футляр	XF8684-001	
28	Комплект листов с координатной сеткой	XC4549-020	
29	Руководство пользователя	Обратитесь к официальному дилеру Brother.	
30	Краткий справочник		

*3 SA156 представляет собой шпульку типа Class15.

◆ Acessórios opcionais

Os acessórios a seguir são opcionais e devem ser adquiridos separadamente em um revendedor autorizado da Brother.

N°	Nome da peça	Código da peça	
		Américas	Outros
1	Calçador aberto	SA186	F060: XE1094-101
2	Calçador antiaderente	SA114	F007N: XC1949-052
3	Calçador de guia de ponto "P"	SA160	F035N: XC1969-052
4	Calçador ajustável de zíper/vivo	SA161	F036N: XC1970-052
5	Calçador de acolchoado	SA129	F005N: XC1948-052
6	Calçador de transporte duplo	SA140	F033N: XC2214-052
7	Calçador de acolchoado 1/4" com guia	SA185	F057: XC7416-252
8	Calçador aberto de movimento livre para acolchoados "O"	SA187	F061: XE1097-001
9	Calçador de movimento livre de acolchoado eco "E"		XE0766-001
10	Calçador de movimento livre de acolchoado "C"		XE0765-101
11	Calçador de acolchoado 1/4"	SA125	F001N: XC1944-052
12	Guia de acolchoado	SA132	F016N: XC2215-052
13	Cortador lateral em "S"	SA177	F054: XC3879-152
14	Suporte de carretel	SA563 (EUA) SA563C (Canadá)	TS7: XG0900-001 TS7AP: XG0902-001
15	Conjunto de calçador de ponto reto e chapa de agulha	SA564 (EUA) SA564C (Canadá)	SNP02: XG0946-001 SNP02AP: XG0948-001
16	Mesa extensora	SAWTNQ1 (EUA) SAWTNQ1C (Canadá)	WT12: XG0955-001 WT12AP: XG0956-001

◆ Дополнительные принадлежности

Перечисленные ниже дополнительные принадлежности можно приобрести отдельно у официального дилера Brother.

№	Наименование	Код изделия	
		Америка	Другие
1	Лапка с открытым мыском	SA186	F060: XE1094-101
2	Скользкая лапка	SA114	F007N: XC1949-052
3	Направляющая лапка "P"	SA160	F035N: XC1969-052
4	Регулируемая лапка для вшивания молнии/канта	SA161	F036N: XC1970-052
5	Стегальная лапка	SA129	F005N: XC1948-052
6	Шагающая лапка	SA140	F033N: XC2214-052
7	Стегальная лапка 1/4 дюйма с направляющей	SA185	F057: XC7416-252
8	Стегальная лапка с открытым мыском "O" для свободной подачи материала	SA187	F061: XE1097-001
9	Стегальная лапка "E" для фигурного выстигивания со свободной подачей материала		XE0766-001
10	Лапка для выстигивания со свободной подачей материала "C"		XE0765-101
11	Стегальная лапка 1/4 дюйма	SA125	F001N: XC1944-052
12	Направляющая для выстигивания	SA132	F016N: XC2215-052
13	Боковой нож "S"	SA177	F054: XC3879-152
14	Стойка для катушек	SA563 (для США), SA563C (для Канады)	TS7: XG0900-001 TS7AP: XG0902-001
15	Игольная пластина и прижимная лапка для прямострочных операций	SA564 (для США), SA564C (для Канады)	SNP02: XG0946-001 SNP02AP: XG0948-001
16	Стол-приставка	SAWTNQ1 (для США), SAWTNQ1C (для Канады)	WT12: XG0955-001 WT12AP: XG0956-001



Bobbin Winding and Setting

Aufspulen des Unterfadens und Einstellung

Bobinage et réglage de la canette

Opwinden en instellen van de spoel

Avvolgimento spolina e caricamento

Bobinado y ajuste

Configuração e enrolamento da bobina

Намотка и установка шпульки

Follow the steps below in numerical order. Refer to the operation manual for detailed instructions.
 Führen Sie die folgenden Schritte in der numerischen Reihenfolge aus. Ausführliche Hinweise finden Sie in der Bedienungsanleitung.
 Respectez les étapes ci-dessous, dans l'ordre numérique. Reportez-vous au manuel d'instructions pour des informations détaillées.
 Volg onderstaande stappen in numerieke volgorde. In de bedieningshandleiding vindt u uitvoerige aanwijzingen.
 Seguire i passaggi di seguito, in ordine numerico. Per le istruzioni dettagliate, consultare il manuale di istruzioni.
 Siga los pasos descritos a continuación, en orden numérico. Consulte las instrucciones detalladas en el manual de instrucciones.
 Siga as etapas abaixo, em ordem numérica. Consulte o manual de operações para obter instruções detalhadas.
 Выполните описанные ниже действия по порядку номеров. Подробные инструкции см. в руководстве пользователя.

Use only the included bobbin or bobbins of the same type.
 Verwenden Sie nur die im Lieferumfang enthaltene Spule oder Spulen vom selben Typ.
 N'utilisez que la canette fournie ou des canettes du même type.
 Gebruik uitsluitend de bijgeleverde spoel of spoelen van hetzelfde type.
 Utilizzare solo la bobina o le bobine in dotazione dello stesso tipo.
 Utilice solo la bobina incluida, o bobinas del mismo tipo.
 Somente use a bobina incluída ou bobinas do mesmo tipo.
 Используйте только прилагаемые шпульки или шпульки того же типа.

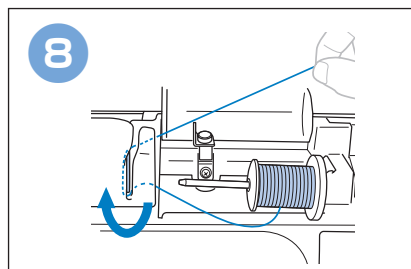
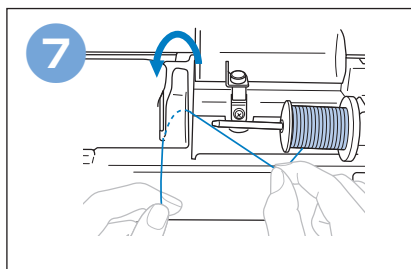
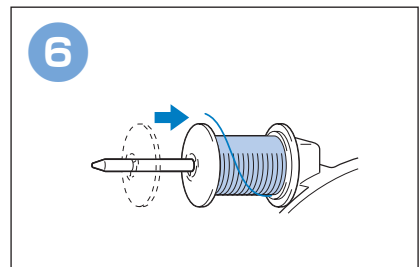
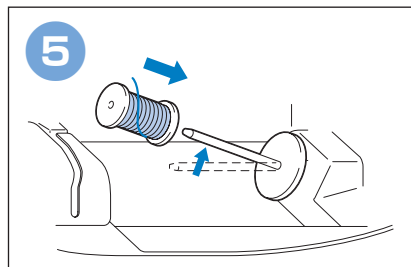
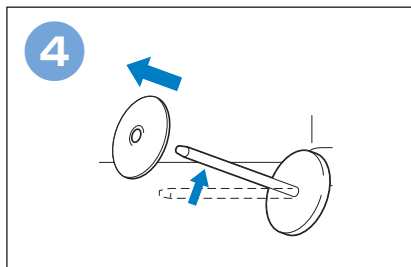
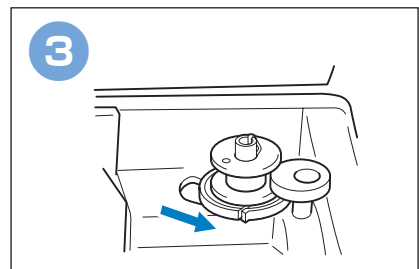
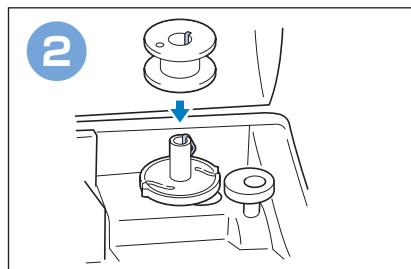
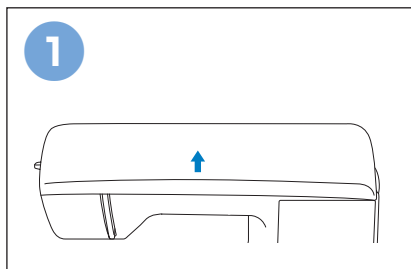
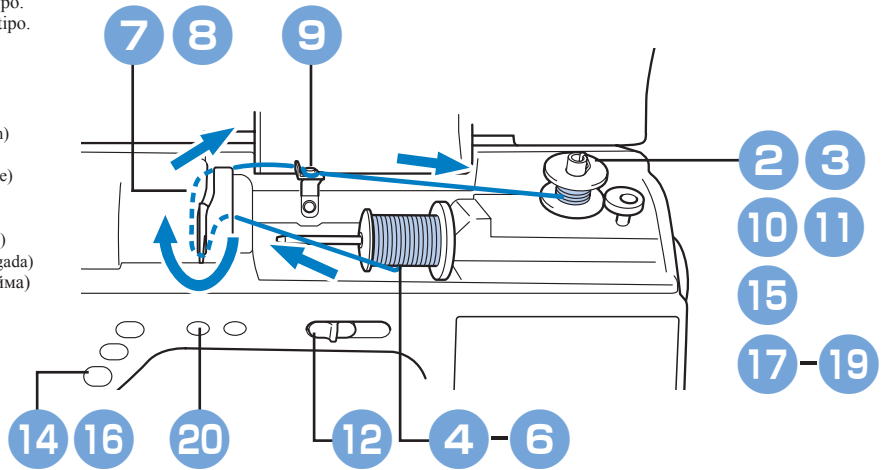
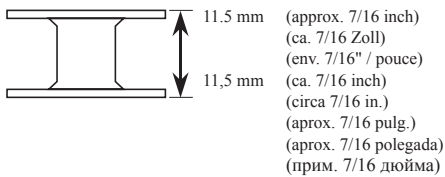

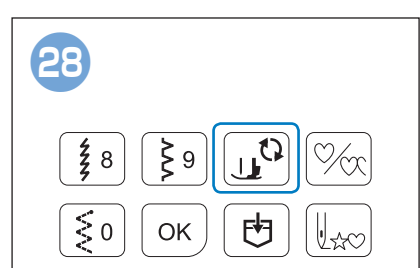
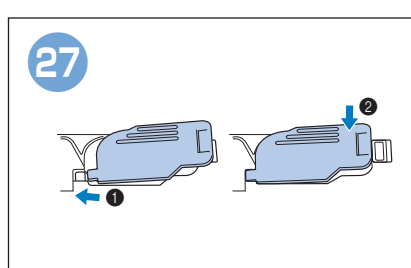
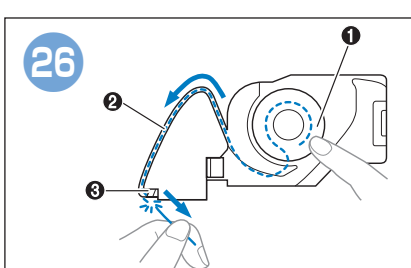
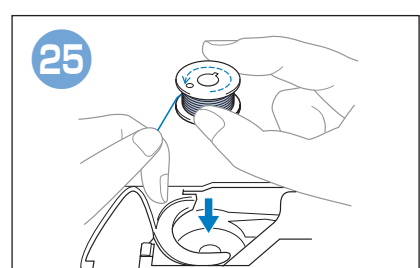
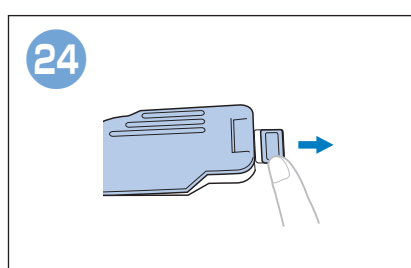
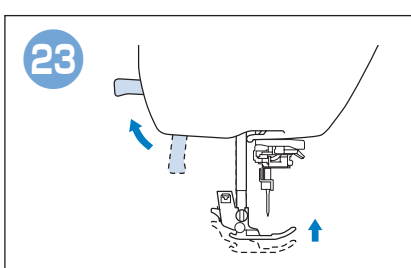
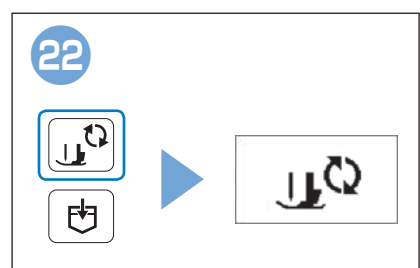
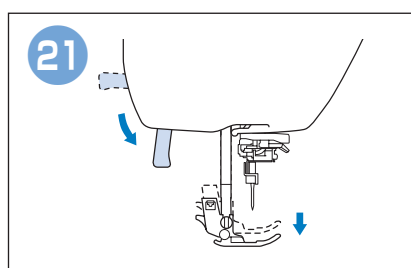
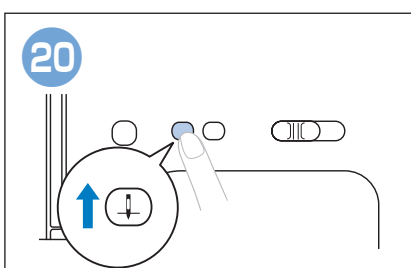
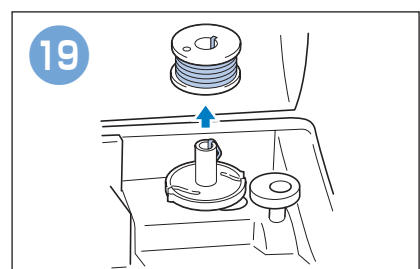
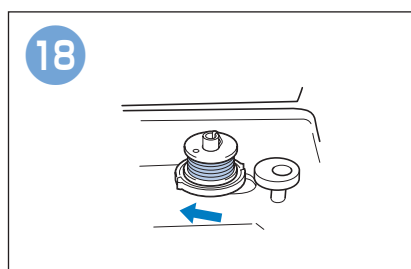
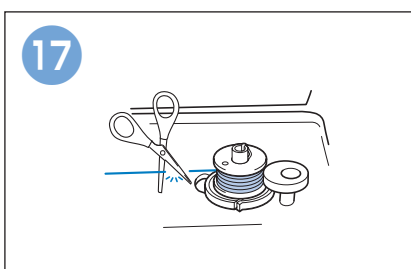
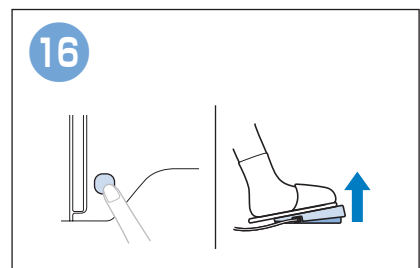
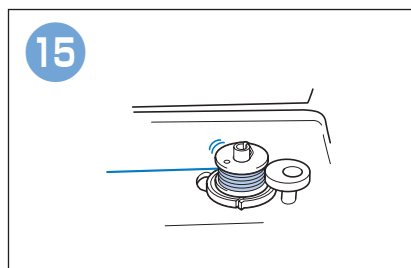
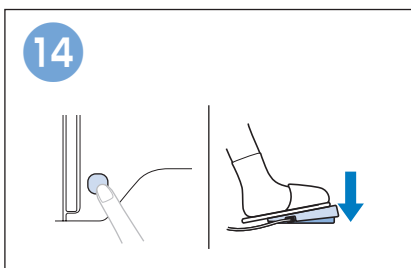
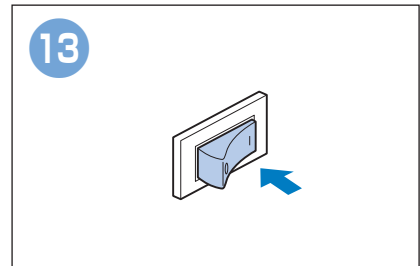
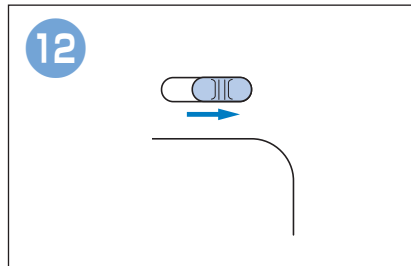
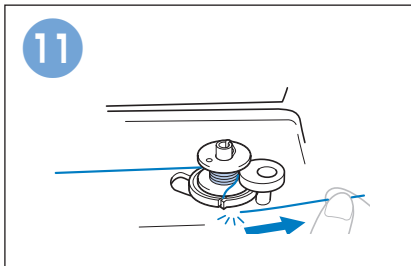
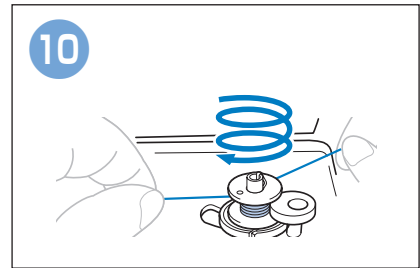
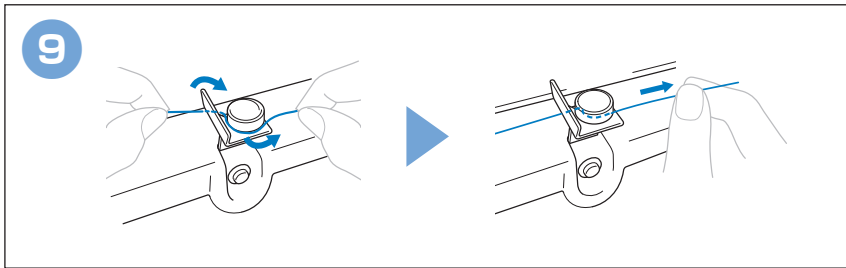

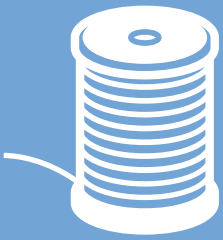

Upper Threading
Einfädeln des Oberfadens
Enfilage supérieur
Inrijgen van de bovendraad
Infilatura superiore
Hilo superior
Passagem da linha superior
Заправка верхней нити

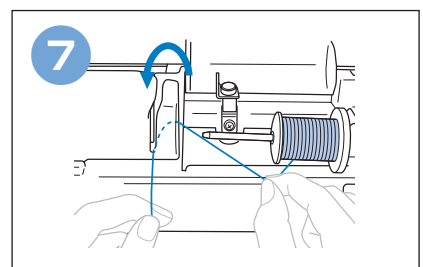
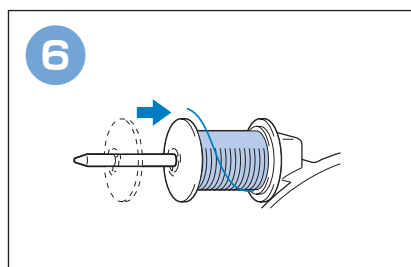
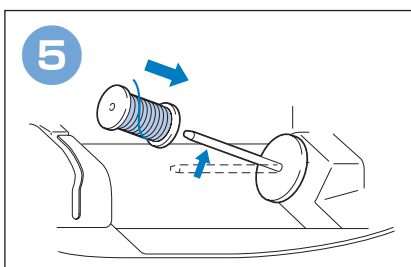
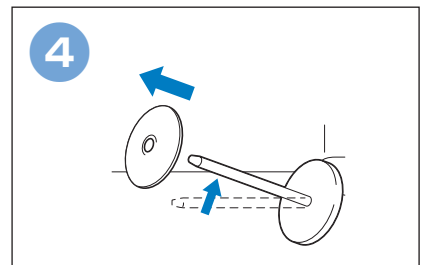
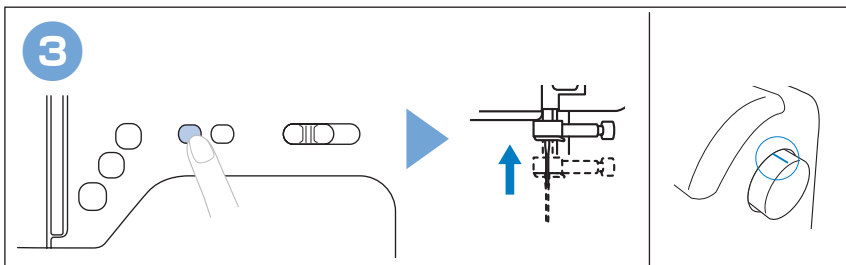
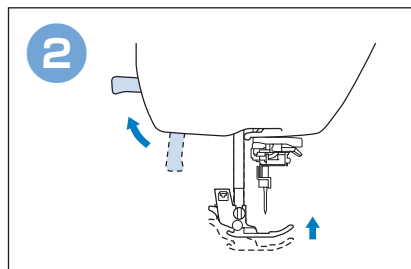
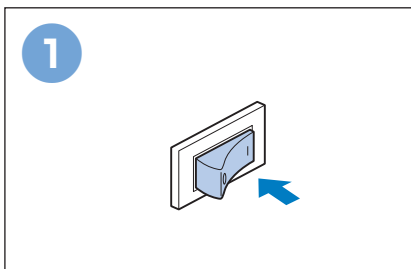
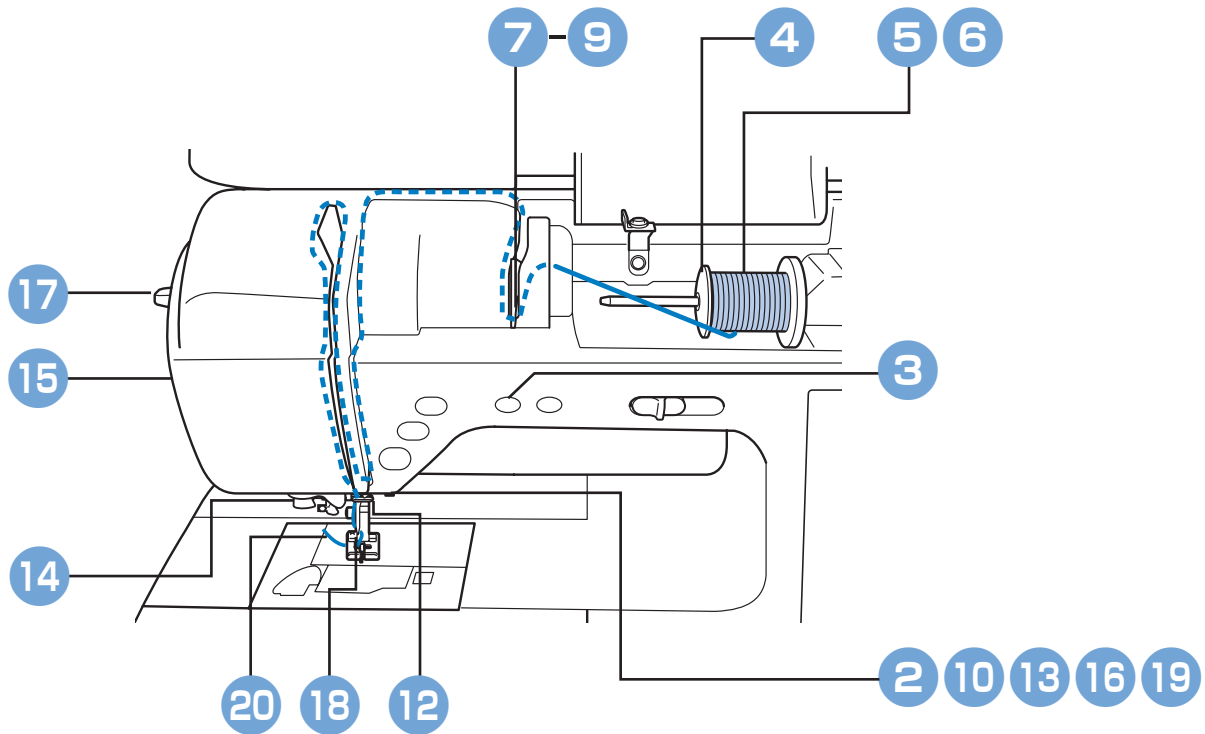

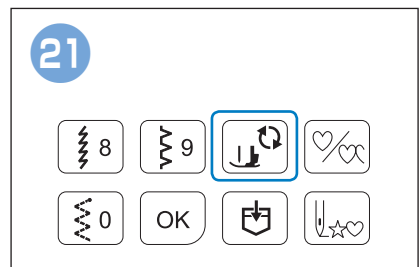
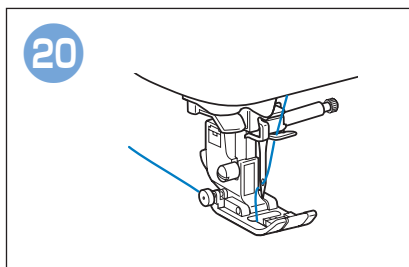
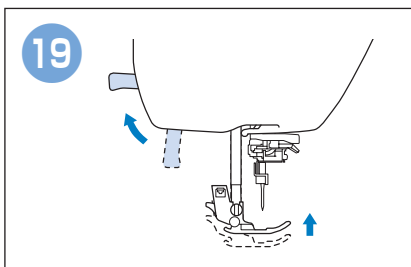
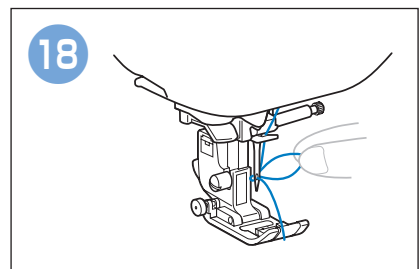
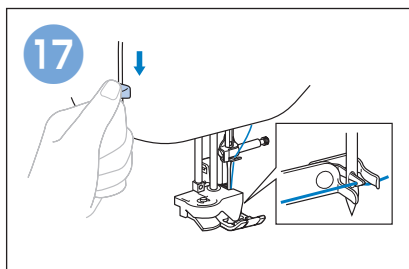
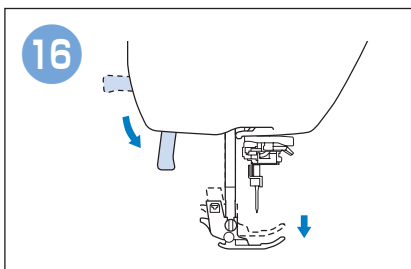
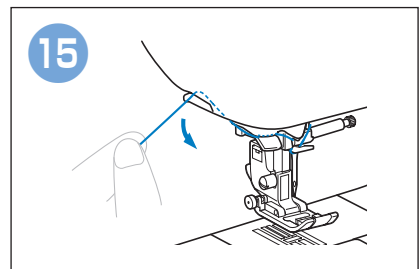
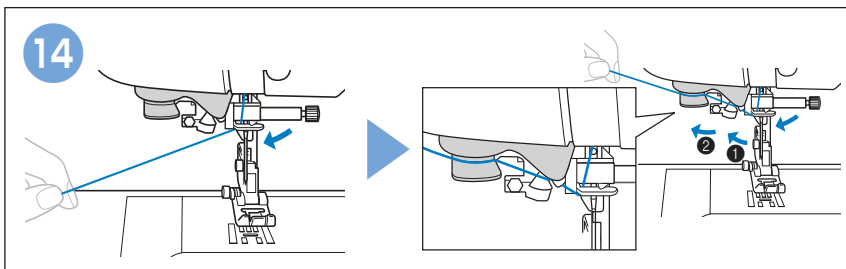
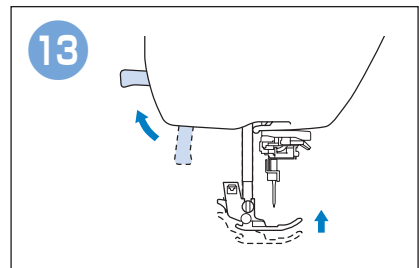
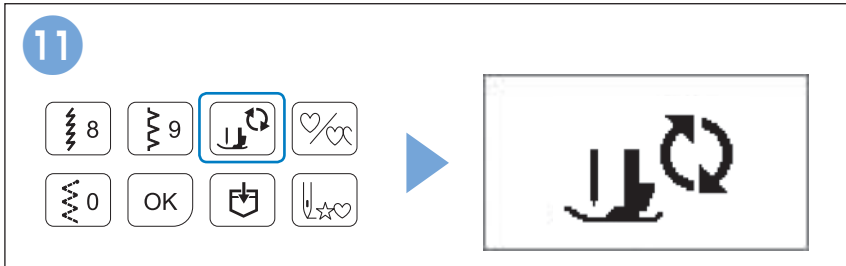
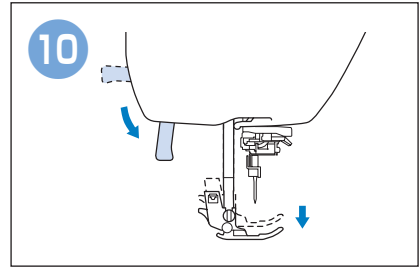
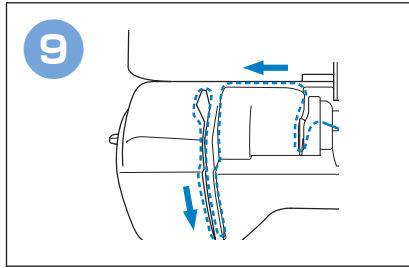
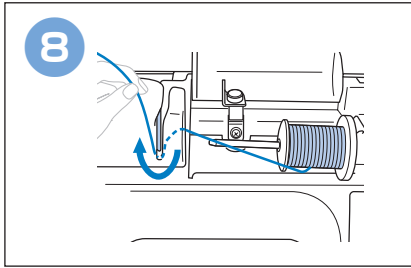



Name of Machine Parts

Bezeichnungen der Maschinenteile

Nom des pièces de la machine

Naam van machine-onderdelen

Nome delle parti della macchina

Nombres de las piezas de la máquina

Nome das peças da máquina

Наименования частей машины

- ◆ Operation buttons ◆ Funktionstasten ◆ Touches de commande ◆ Bedieningstoetsen
 ◆ Pulsanti di funzionamento ◆ Botones de operación ◆ Botões de operação ◆ Кнопки управления

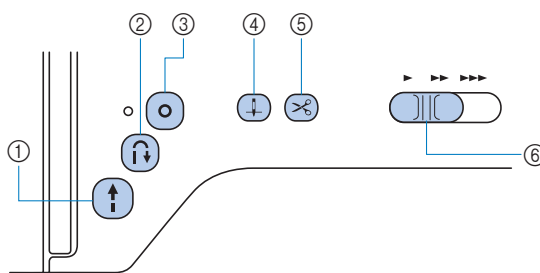

- ① “Start/Stop” button
 ② Reverse stitch button
 ③ Reinforcement stitch button
 ④ Needle position button
 ⑤ Thread cutter button
 ⑥ Sewing speed controller

- ① Taste „Start/Stopp“
 ② Taste „Rückwärtsstich“
 ③ Taste „Verstärkungsstich“
 ④ Taste „Nadelposition“
 ⑤ Taste „Fadenabschneider“
 ⑥ Nähgeschwindigkeitsregler

- ① Touche « Marche/arrêt »
 ② Touche Point inverse
 ③ Touche Point de renfort
 ④ Touche Positionnement aiguille
 ⑤ Touche Coupe-fil
 ⑥ Commande de vitesse de couture

- ① “Start/Stop”-toets
 ② Achteruitsteektoets
 ③ Verstevigingssteektoets
 ④ Naaldstandtoets
 ⑤ Draadafkniptoets
 ⑥ Schuifknop voor snelheidsregeling

- ① Pulsante “Avvio/Stop”
 ② Pulsante “Punto di fermatura”
 ③ Pulsante “Punto di rinforzo”
 ④ Pulsante “Posizione ago”
 ⑤ Pulsante “Taglio del filo”
 ⑥ Regolatore della velocità di cucitura

- ① Botón de “inicio/parar”
 ② Botón de puntada en reversa
 ③ Botón de puntada de remate
 ④ Botón de posición de aguja
 ⑤ Botón de corte de hilo
 ⑥ Control de velocidad manual

- ① Botão “Iniciar/Parar”
 ② Botão de ponto reverso
 ③ Botão de ponto de reforço
 ④ Botão de posição da agulha
 ⑤ Botão do cortador de linha
 ⑥ Controlador de velocidade de costura

- ① Кнопка “Пуск/Стоп”
 ② Кнопка “Обратные стежки”
 ③ Кнопка “Закрепляющие стежки”
 ④ Кнопка “Положение иглы”
 ⑤ Кнопка “Обрезка нити”
 ⑥ Регулятор скорости шитья

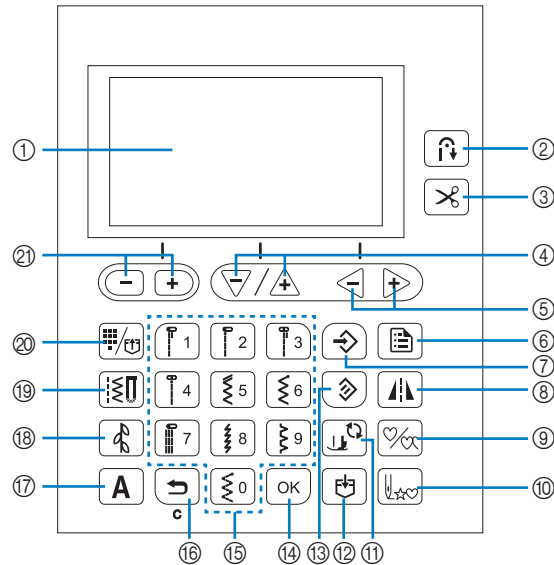

- ① LCD (liquid crystal display)
- ② Automatic reverse/reinforcement key
- ③ Automatic thread cutting key
- ④ Stitch length keys/Item selection keys
- ⑤ Value selection keys
- ⑥ Settings key
- ⑦ Manual memory key
- ⑧ Mirror image key
- ⑨ Single/repeat sewing key
- ⑩ Back to beginning key
- ⑪ Presser foot/Needle exchange key
- ⑫ Memory key
- ⑬ Reset key
- ⑭ OK key
- ⑮ Numeric keys
- ⑯ Back key
- ⑰ Character stitch key
- ⑱ Decorative stitch key
- ⑲ Utility stitch key
- ⑳ Preset utility stitch/saved pattern key
- ㉑ Stitch width keys/Settings screen page selection keys

- ① LCD-Bildschirm (Flüssigkristallanzeige)
- ② Taste zum automatischen Vernähen
- ③ Automatische Fadenabschneidetaste
- ④ Tasten für Stichlänge/Elementauswahl
- ⑤ Wertauswahl-tasten
- ⑥ Taste „Einstellungen“
- ⑦ Manuelle Speichertaste
- ⑧ Spiegelbildtaste
- ⑨ Einzeln/Mehrfach-Nähtaste
- ⑩ Taste „Zurück zum Anfang“
- ⑪ Taste „Nähfuß-/Nadelwechsel“
- ⑫ Speichertaste
- ⑬ Rücksteltaste
- ⑭ OK-Taste
- ⑮ Numerische Tasten
- ⑯ Taste „Zurück“
- ⑰ Buchstabenstichtaste
- ⑱ Dekorstichtaste
- ⑲ Nutztstichtaste
- ⑳ Taste „Voreingestellter Nutztstich/Gespeichertes Muster“
- ㉑ Stichbreitentasten/Auswahl-tasten für Seite des Einstellungsbildschirms

- ① Écran à cristaux liquides
- ② Touche de point inverse/de renfort automatique
- ③ Touche de coupure de fil automatique
- ④ Touches de longueur de point/Touches de sélection d'élément
- ⑤ Touches de sélection de valeur
- ⑥ Touche de réglages
- ⑦ Touche de mémoire manuelle
- ⑧ Touche d'image en miroir
- ⑨ Touche de couture en points uniques/en continu
- ⑩ Retour à la touche de début
- ⑪ Touche de remplacement du pied-de-biche/de l'aiguille
- ⑫ Touche de mise en mémoire
- ⑬ Touche de réinitialisation
- ⑭ Touche OK
- ⑮ Touches numériques
- ⑯ Touche arrière
- ⑰ Touche de points de caractères
- ⑱ Touche de points décoratifs
- ⑲ Touche de points de couture courants
- ⑳ Touche de pré-réglage de point de couture courant/motif enregistré
- ㉑ Touches de largeur de point/Touches de sélection des pages de l'écran de réglages

- ① Display
- ② Automatisch achteruit/verstevigingssteektoets
- ③ Automatische draadafknijtoets
- ④ Toetsen voor steeklengte/optieselectie
- ⑤ Toetsen voor waarde kiezen
- ⑥ Instellingentoets
- ⑦ Handmatig geheugentoets
- ⑧ Spiegelttoets
- ⑨ Enkele/meerdere stekentoets
- ⑩ Terug naar beginttoets
- ⑪ Persvoet-/naaldwisseltoets
- ⑫ Geheugentoets
- ⑬ Hersteltoets
- ⑭ OK-toets
- ⑮ Numerieke toetsen
- ⑯ Terugtoets
- ⑰ Toets voor lettersteken
- ⑱ Toets voor siersteken
- ⑲ Naaistekentoets
- ⑳ Toets voor vooraf ingestelde naaisteek/opgeslagen patroon
- ㉑ Toetsen voor steekbreedte/selectie van instellingenschermpagina's

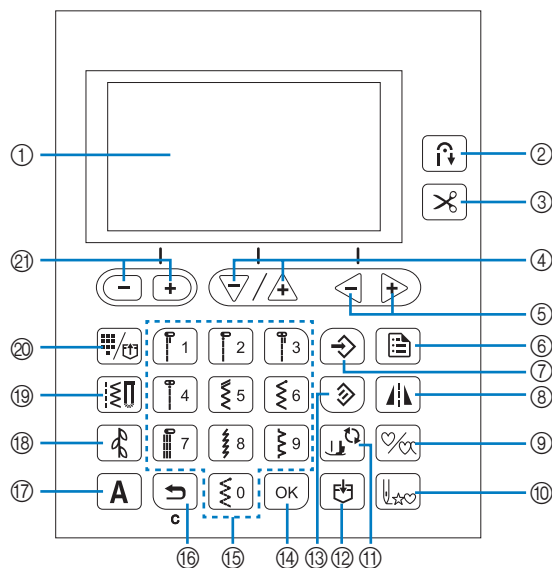

- ① LCD (display a cristalli liquidi)
- ② Tasto Punto di fermatura/rinforzo automatico
- ③ Tasto Taglio automatico del filo
- ④ Tasti Lunghezza punto/tasti di selezione delle voci
- ⑤ Tasti di selezione dei valori
- ⑥ Tasto Impostazioni
- ⑦ Tasto Memoria manuale
- ⑧ Tasto Immagine riflessa
- ⑨ Tasto Cucitura singola/ripetuta
- ⑩ Tasto Torna all'inizio
- ⑪ Tasto Sostituzione ago/piedino premistoffa
- ⑫ Tasto Memoria
- ⑬ Tasto Reimposta
- ⑭ Tasto OK
- ⑮ Tasti numerici
- ⑯ Tasto Indietro
- ⑰ Tasto Punto a caratteri
- ⑱ Tasto Punto decorativo
- ⑲ Tasto Punto utile
- ⑳ Tasto Punto utile preimpostato/Punto salvato
- ㉑ Tasti Larghezza punto/tasti di selezione della pagina della schermata Impostazioni

- ① Pantalla LCD (pantalla de cristal líquido)
- ② Tecla de puntada en reversa/remate automática
- ③ Tecla de corte automático de hilo
- ④ Teclas de longitud de la puntada/Teclas de selección de elemento
- ⑤ Teclas de selección del valor
- ⑥ Tecla de ajustes
- ⑦ Tecla de memoria manual
- ⑧ Tecla de efecto espejo
- ⑨ Tecla de costura sencilla/doble
- ⑩ Tecla para volver al principio
- ⑪ Tecla de cambio del pie prensatela/aguja
- ⑫ Tecla de memoria
- ⑬ Tecla de borrado
- ⑭ Tecla Aceptar
- ⑮ Teclas numéricas
- ⑯ Tecla de retroceso
- ⑰ Tecla de puntada de carácter
- ⑱ Tecla de puntada decorativa
- ⑲ Tecla de puntada de utilidad
- ⑳ Tecla de puntada de utilidad predefinida/patrón guardado
- ㉑ Teclas de anchura de la puntada/Teclas de selección de página de la pantalla de ajustes

- ① LCD (tela de cristal líquido)
- ② Tecla automática de reverso/reforço
- ③ Tecla do cortador de linha automático
- ④ Teclas de comprimento do ponto/Teclas de seleção de item
- ⑤ Teclas de seleção de valor
- ⑥ Tecla de configurações
- ⑦ Tecla de memória manual
- ⑧ Tecla de espelhamento da imagem
- ⑨ Tecla de costura simples/repeter
- ⑩ Tecla Voltar para o início
- ⑪ Tecla para troca do pé-calcador/agulha
- ⑫ Tecla de memória
- ⑬ Tecla de reconfiguração
- ⑭ Tecla OK
- ⑮ Teclas numéricas
- ⑯ Tecla Voltar
- ⑰ Tecla do ponto de caractere
- ⑱ Tecla de ponto decorativo
- ⑲ Tecla de ponto utilitário
- ⑳ Tecla de ponto utilitário predefinido/padrão salvo
- ㉑ Teclas de largura do ponto/teclas de seleção da página da tela de configurações

- ① ЖКД (жидкокристаллический дисплей)
- ② Кнопка автоматического выполнения обратных/закрепляющих стежков
- ③ Кнопка установки автоматической обрезки нитей
- ④ Кнопки выбора длины стежка/кнопки выбора параметров
- ⑤ Кнопки выбора значения
- ⑥ Кнопка "Настройки"
- ⑦ Кнопка ручного сохранения в памяти
- ⑧ Кнопка зеркального отображения
- ⑨ Кнопка выбора однократного/повторяющегося вышивания рисунка
- ⑩ Кнопка возврата к началу
- ⑪ Кнопка замены прижимной лапки/иглы.
- ⑫ Кнопка памяти
- ⑬ Кнопка сброса
- ⑭ Кнопка "OK"
- ⑮ Цифровые кнопки
- ⑯ Кнопка "Назад"
- ⑰ Кнопка "Символьная строчка"
- ⑱ Кнопка "Декоративная строчка"
- ⑲ Кнопка "Основная строчка"
- ⑳ Кнопка выбора предварительно заданной основной строчки/сохраненного рисунка
- ㉑ Кнопки настройки ширины строчки/кнопки выбора страницы экрана настроек

- ◆ Settings screen ◆ Einstellungsbildschirm ◆ Écran de réglages ◆ Instellingscherm
- ◆ Schermata Impostazioni ◆ Pantalla de ajustes ◆ Configurações da tela ◆ Экрaн настроек

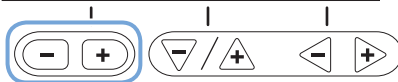
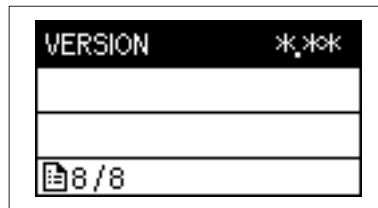
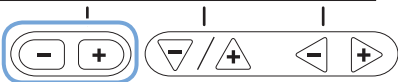
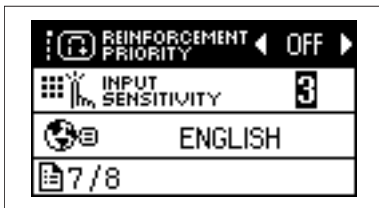
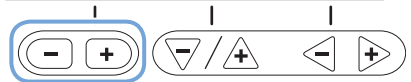
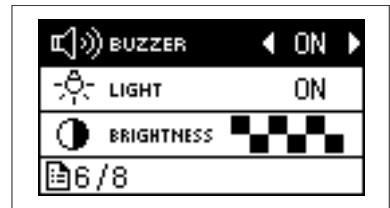
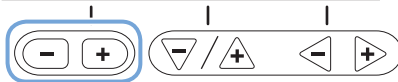
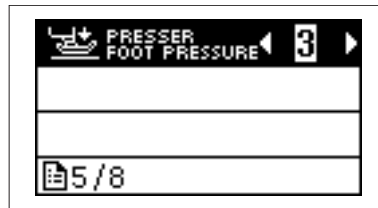
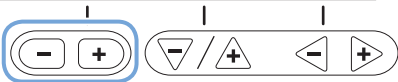
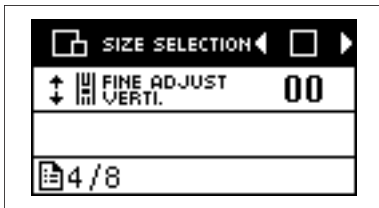
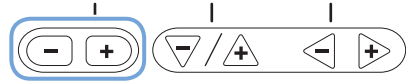
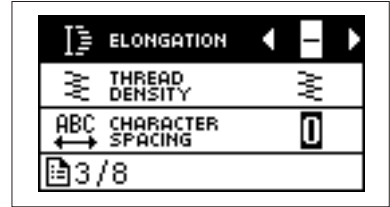
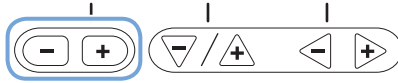
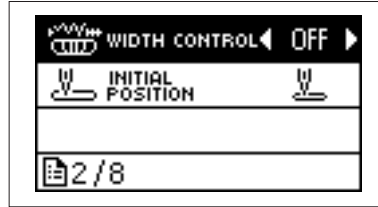
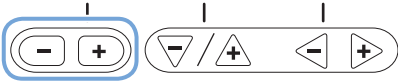
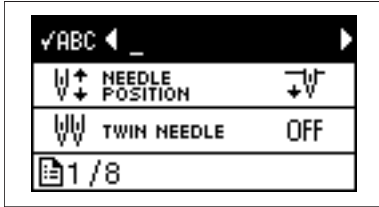
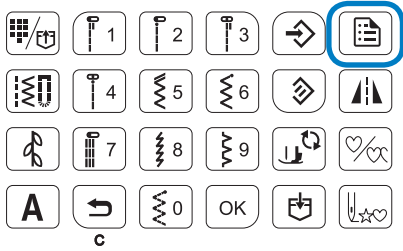



Selecting and Sewing Patterns
Auswählen und Nähen von Stichen
Sélection et couture de motifs
Steken selecteren en naaien
Selezione e cucitura di motivi
Seleccionar y coser patrones
Seleção e costura de padrões
Выбор швейных строчек

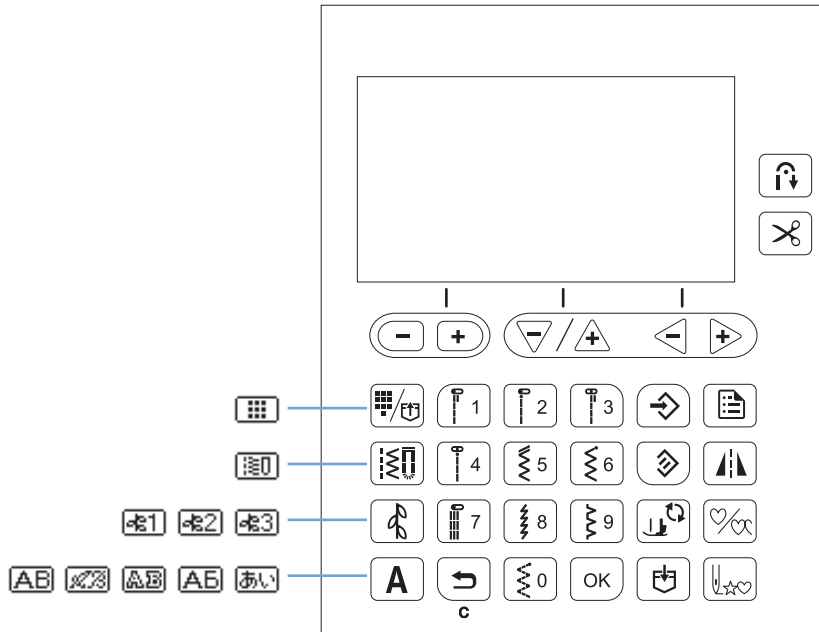

◆ Preset Utility Stitches
 ◆ Puntti utili preimpostati

◆ Voreingestellte Nutzstiche
 ◆ Puntadas de utilidad predefinidas

◆ Préréglage des points de couture courants
 ◆ Pontos utilitários predefinidos

◆ Vooraf ingestelde naaisteken
 ◆ Предварительно заданные основные строчки

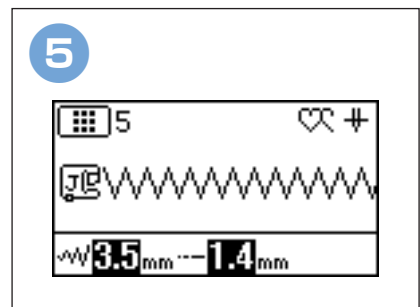
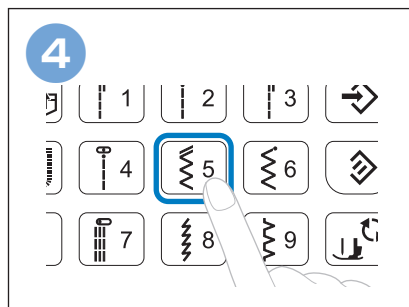
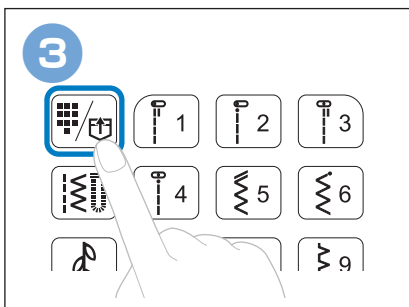
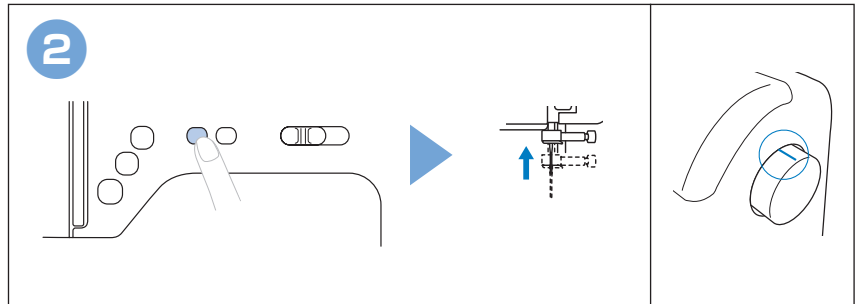
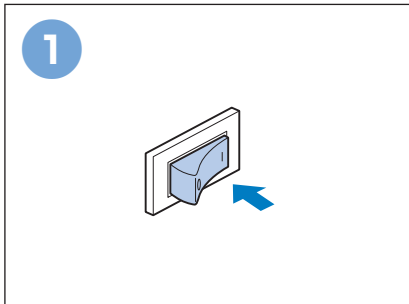

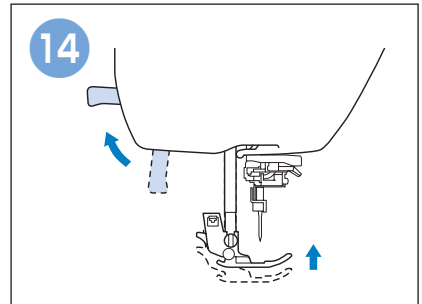
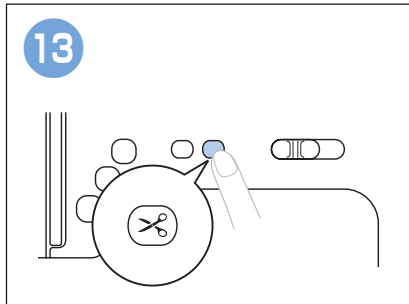
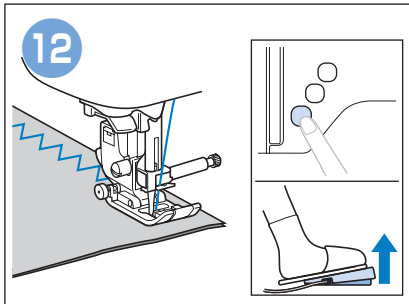
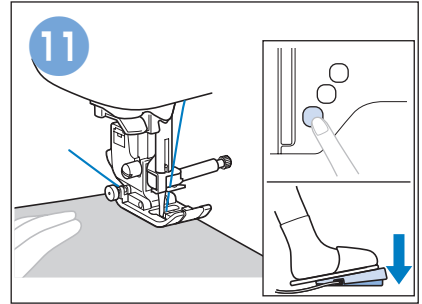
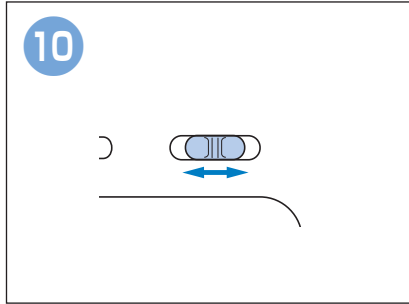
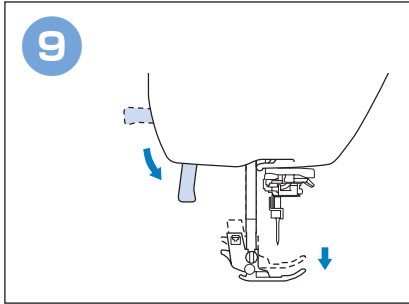
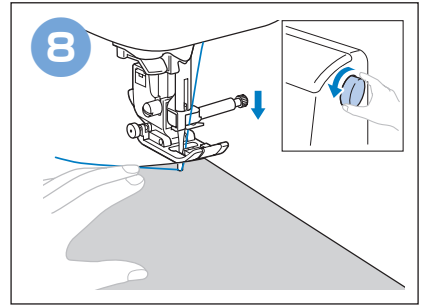
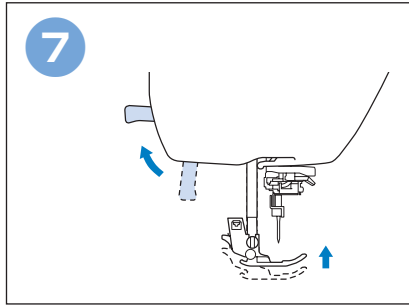
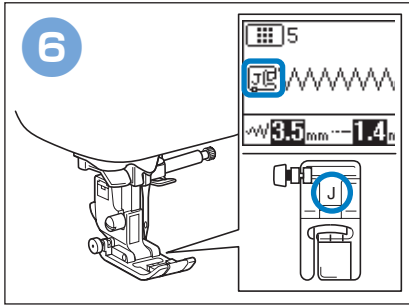

◆ Utility Stitches
◆ Punti utili

◆ Nutztstiche
◆ Puntadas de utilidad

◆ Points de couture courants
◆ Pontos utilitários

◆ Naaisteken
◆ Основные строчки

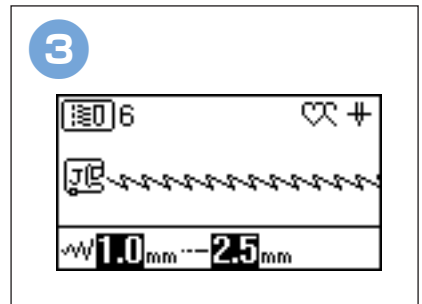
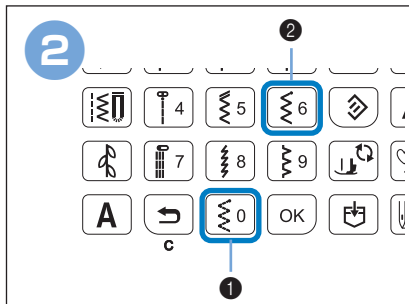
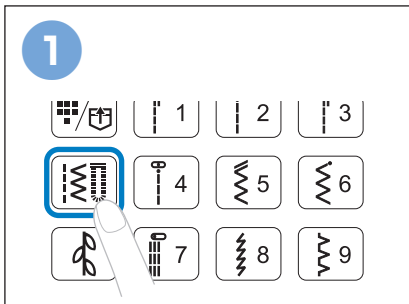

◆ Decorative Stitches ◆ Dekorstiche ◆ Points décoratifs ◆ Decoratieve steken
 ◆ Puntti decorativi ◆ Puntadas decorativas ◆ Pontos decorativos ◆ Декоративные строчки

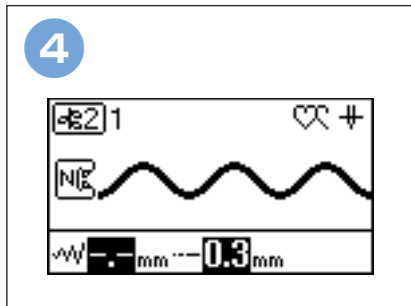
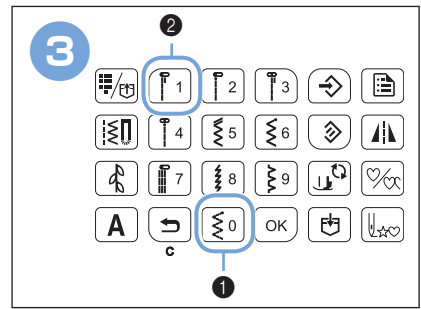
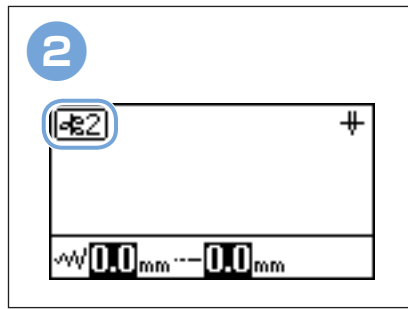
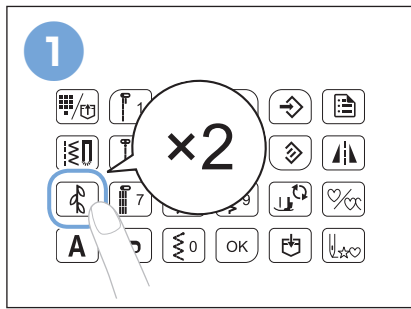

◆ Character stitches ◆ Buchstabenstiche ◆ Points de caractères ◆ Lettersteken
 ◆ Puntti a caratteri ◆ Puntadas de carácter ◆ Pontos de caracteres ◆ Символьные строчки

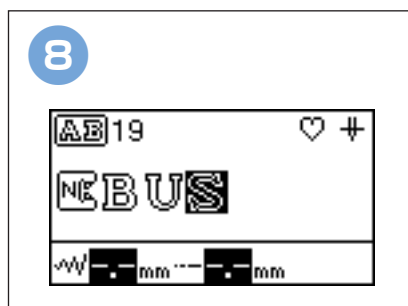
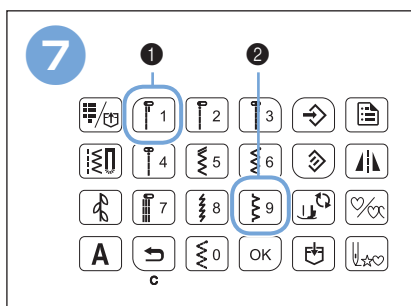
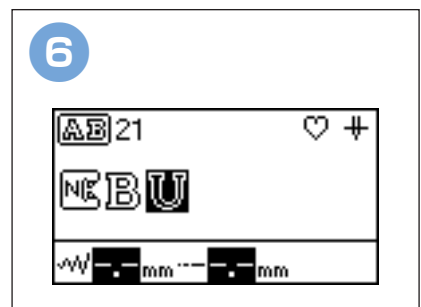
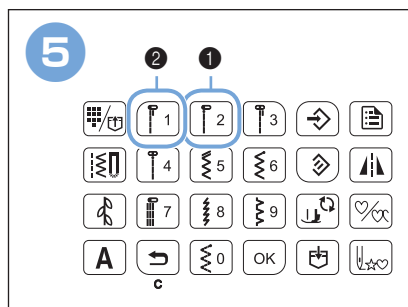
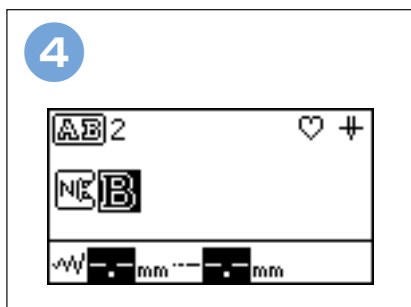
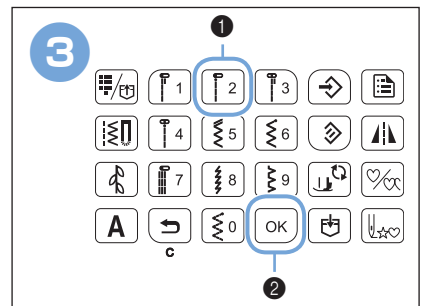
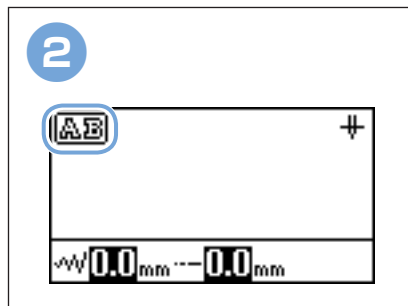
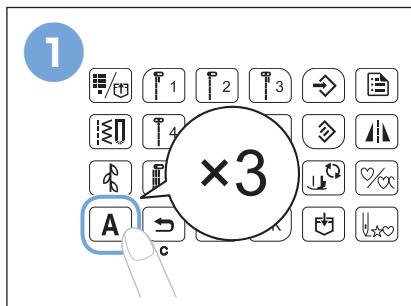



Summary of Stitch Patterns

Stich-Übersicht

Sommaire des motifs de point

Steken overzicht

Sommario degli schemi punto

Resumen de tipos de puntada

Resumo dos padrões de ponto

Рисунки строчек

◆ Preset Utility Stitches
◆ Punti utili preimpostati

◆ Voreingestellte Nutztische
◆ Puntadas de utilidad predefinidas

◆ Préréglage des points de couture courants
◆ Pontos utilitários predefinidos

◆ Vooraf ingestelde naaisteken
◆ Предварительно заданные основные строчки



◆ Utility Stitches
◆ Punti utili

◆ Nutztische
◆ Puntadas de utilidad

◆ Points de couture courants
◆ Pontos utilitários

◆ Naaisteken
◆ Основные строчки

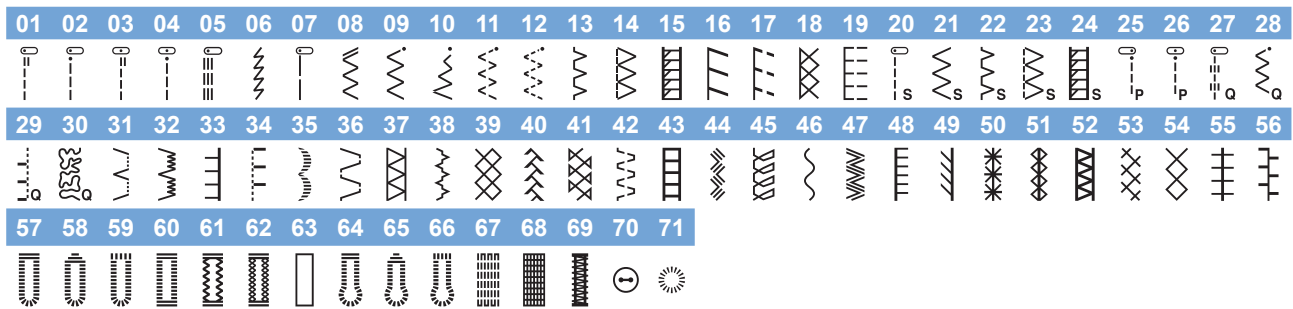

◆ Decorative Stitches
◆ Punti decorativi

◆ Dekorstiche
◆ Puntadas decorativas

◆ Points décoratifs
◆ Pontos decorativos

◆ Decoratieve steken
◆ Декоративные строчки

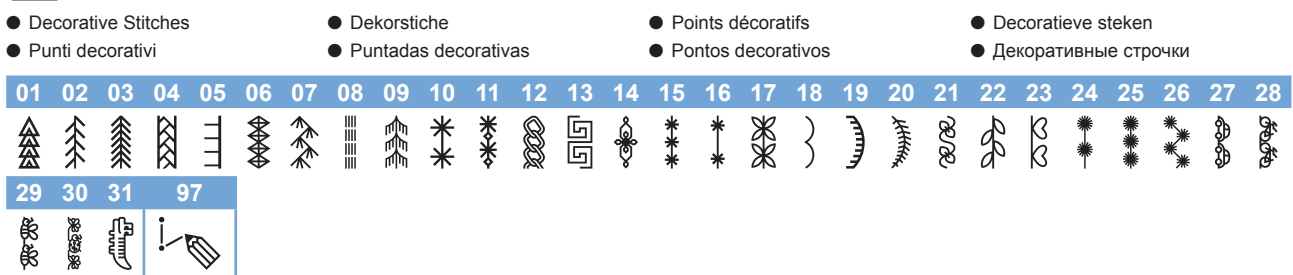

* 31:Pattern for making adjustment, 97:MY CUSTOM STITCH
 * 31:Einstellungsmuster, 97:MY CUSTOM STITCH (Mein Stichdesign)
 * 31 : Motif d'ajustement, 97 : MY CUSTOM STITCH (MON POINT PERSONNALISÉ)
 * 31: patroon voor aanpassing, 97: MY CUSTOM STITCH
 * 31:Disegno per eseguire la regolazione, 97:MY CUSTOM STITCH (PUNTI PERSONALIZZATI)
 * 31: Patrón para hacer el ajuste, 97: MY CUSTOM STITCH (Mi puntada preferida)
 * 31:Padrão para fazer ajustes, 97:MEU PONTO PERSONALIZADO
 * 31:Строчка для выполнения настройки, 97:MY CUSTOM STITCH (Моя строчка)



- Satin stitches (01-10)
7 mm satin stitches (11-27)
Cross stitch stitches (28-38)
- Satinstiche (01-10)
7 mm Satinstiche (11-27)
Kreuzstiche (28-38)
- Points plumetis (01-10)
Points plumetis 7 mm (11-27)
Points de croix (28-38)
- Satijnsteken (01-10)
7 mm satijnsteken (11-27)
Kruissteken (28-38)
- Puntii pini (01-10)
Puntii pini da 7 mm (11-27)
Puntii croce (28-38)
- Costuras para satén (01-10)
Puntadas satinadas de 7 mm (11-27)
Puntadas de punto de cruz (28-38)
- Pontos cheios (01-10)
Pontos cheios de 7 mm (11-27)
Pontos em ponto cruz (28-38)
- Атласные строчки (01-10)
Атласные строчки 7 мм (11-27)
Крестовидные строчки (28-38)

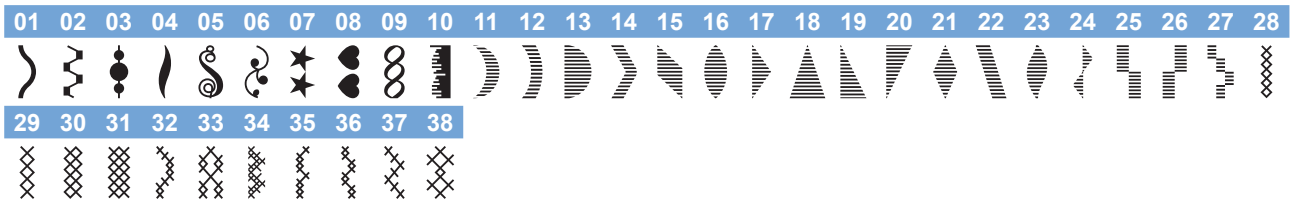

- Utility decorative stitch patterns
- Decoratieve naaisteken
- Padrões de ponto utilitário decorativo
- Dekorative Gebrauchsstichmuster
- Disegni/punti utili decorativi
- Рисунки основных декоративных строчек
- Motifs de points décoratifs courants
- Puntadas decorativas utilitarias

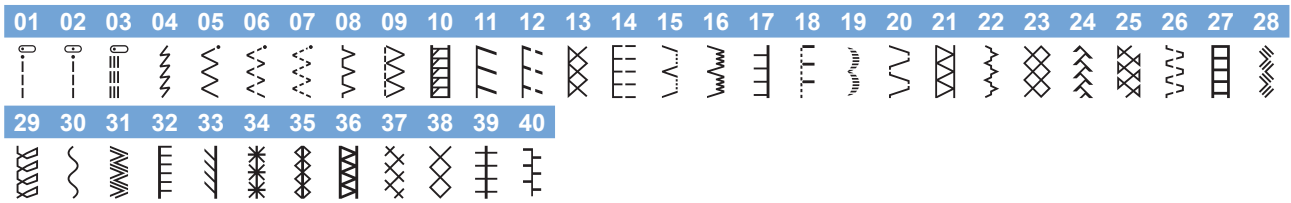

◆ Character stitches
◆ Puntti a caratteri

◆ Buchstabenstiche
◆ Puntadas de carácter

◆ Points de caractères
◆ Pontos de caracteres

◆ Lettersteken
◆ Символьные строчки

A x1 ▶ AB

● Gothic font
● Carattere Gothic

● Schriftart Gotisch
● Fuente gótica

● Police gothique
● Fonte gótica

● Gothic lettertype
● Готический шрифт

1	2	3	4	5	6	7	8	9	10	11	12	13	14	15	16	17	18	19	20	21	22	23	24	25	26
A	B	C	D	E	F	G	H	I	J	K	L	M	N	O	P	Q	R	S	T	U	V	W	X	Y	Z
27	28	29	30	31	32	33	34	35	36	37	38	39	40	41	42	43	44	45	46	47	48	49	50	51	52
0	1	2	3	4	5	6	7	8	9	#	%	-	+	x	÷	=	*	.	,	&	?	!	@	<	>
53	54	55	56	57	58	59	60	61	62	63	64	65	66	67	68	69	70	71	72	73	74	75	76	77	78
()	[]	/	\	~	©	®	™	“	”	”	’	‘	’	_	Ä	À	Æ	Ç	Ð	Ñ	Ö	Ø	Œ
79	80																								
U	B																								

A x2 ▶ AB

● Handwriting font
● Carattere corsivo

● Schriftart Handschrift
● Fuente de escritura a mano

● Police manuscrite
● Fonte manuscrita

● Handschriftlettertype
● Рукописный шрифт

1	2	3	4	5	6	7	8	9	10	11	12	13	14	15	16	17	18	19	20	21	22	23	24	25	26
A	B	C	D	E	F	G	H	I	J	K	L	M	N	O	P	Q	R	S	T	U	V	W	X	Y	Z
27	28	29	30	31	32	33	34	35	36	37	38	39	40	41	42	43	44	45	46	47	48	49	50	51	52
0	1	2	3	4	5	6	7	8	9	#	%	-	+	x	÷	=	*	.	,	&	?	!	@	<	>
53	54	55	56	57	58	59	60	61	62	63	64	65	66	67	68	69	70	71	72	73	74	75	76	77	78
()	[]	/	\	~	©	®	™	“	”	”	’	‘	’	_	Ä	À	Æ	Ç	Ð	Ñ	Ö	Ø	Œ
79	80																								
U	B																								

A ×3 ▶ **AB**

- Outline
- Contorno

- Umriss
- Con borde

- Contour
- Contorno

- Contour
- Контурный шрифт

1	2	3	4	5	6	7	8	9	10	11	12	13	14	15	16	17	18	19	20	21	22	23	24	25	26
A	B	C	D	E	F	G	H	I	J	K	L	M	N	O	P	Q	R	S	T	U	V	W	X	Y	Z
27	28	29	30	31	32	33	34	35	36	37	38	39	40	41	42	43	44	45	46	47	48	49	50	51	52
0	1	2	3	4	5	6	7	8	9	#	%	-	+	×	÷	≡	*	.	,	&	?	!	@	<	>
53	54	55	56	57	58	59	60	61	62	63	64	65	66	67	68	69	70	71	72	73	74	75	76	77	78
()	[]	/	\	~	©	®	™	“	”	”	’	‘	’	_	Ä	Å	Æ	Ç	Ð	Ñ	Ö	Ø	Œ
79	80																								
Ù	Û																								

A ×4 ▶ **AB**

- Cyrillic font
- Carattere cirillico

- Schriftart Kyrillisch
- Fuente cirilica

- Police cyrillique
- Fonte cirilica

- Cyrillich lettertype
- Русский шрифт

1	2	3	4	5	6	7	8	9	10	11	12	13	14	15	16	17	18	19	20	21	22	23	24	25	26
А	Б	В	Г	Д	Е	Ё	Ж	З	И	Й	К	Л	М	Н	О	П	Р	С	Т	У	Ф	Х	Ц	Ч	Ш
27	28	29	30	31	32	33	34	35	36	37	38	39	40	41	42	43	44	45	46	47	48	49	50	51	52
Щ	ъ	ы	ь	Э	Ю	Я	Є	І	ї	Ў	Ҁ	ҁ	Ј	Ј	њ	џ	Ѓ	Ѕ	Ќ	0	1	2	3	4	
53	54	55	56	57	58	59	60	61	62	63	64	65	66	67	68										
5	6	7	8	9	-	.	,	&	?	!	()	/	'	_										

A ×5 ▶ **あい**

- Japanese font
- Carattere giapponese
- Schriftart Japanisch
- Fuente japonesa
- Police japonaise
- Fonte japonesa
- Japans lettertype
- Японский шрифт

1	2	3	4	5	6	7	8	9	10	11	12	13	14	15	16	17	18	19	20	21	22	23	24	25	26
あいいうえおあいうえおかきくけこがぎぐげごさしすせそざ																									
27	28	29	30	31	32	33	34	35	36	37	38	39	40	41	42	43	44	45	46	47	48	49	50	51	52
じずぜぞたちつてとだぢづてどっなにぬねのはひふへほば																									
53	54	55	56	57	58	59	60	61	62	63	64	65	66	67	68	69	70	71	72	73	74	75	76	77	78
びぶべぼばびぶぺぽまみむめもやゆよゃゅょらりるれろわ																									
79	80	81	82	83	84	85	86	87	88	89	90	91	92	93	94	95	96	97	98	99	100	101	102	103	104
をんアイウエオァィゥェォヴカキクケコガギグゲゴサシス																									
105	106	107	108	109	110	111	112	113	114	115	116	117	118	119	120	121	122	123	124	125	126	127	128	129	130
セソザジズゼゾタチツテトダヂヅデドッナニヌネノハヒフ																									
131	132	133	134	135	136	137	138	139	140	141	142	143	144	145	146	147	148	149	150	151	152	153	154	155	156
へほバビブベボパピプペポマミムメモヤユヨャュョラリル																									
157	158	159	160	161	162	163	164	165	166	167	168	169	170	171	172	173	174	175	176	177	178	179	180	181	182
レロフヲン01234567890ー二三四五六七八九十																									
183	184	185	186	187	188	189	190	191	192	193	194	195	196	197	198	199	200	201	202	203	204	205	206	207	208
&?!()ー生年月日才保育幼稚園小中学校組部火水木金																									
209	210																								
土 _																									

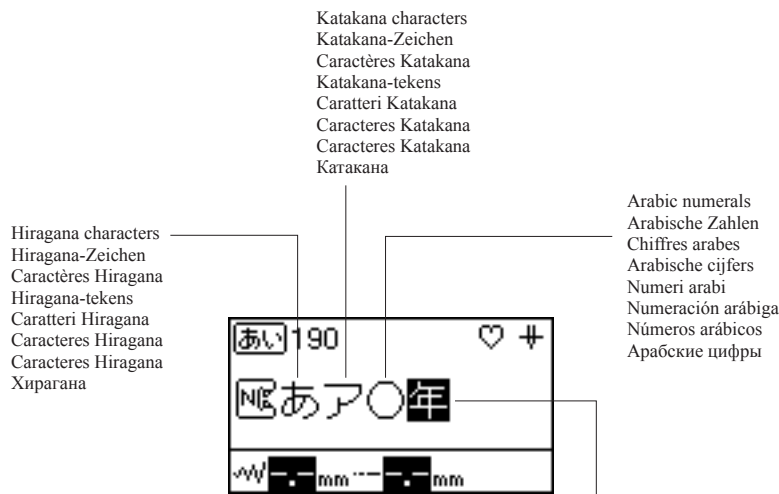

Hiragana characters
Hiragana-Zeichen
Caractères Hiragana
Hiragana-tekens
Caratteri Hiragana
Caracteres Hiragana
Caracteres Hiragana
Хирагана

Katakana characters
Katakana-Zeichen
Caractères Katakana
Katakana-tekens
Caratteri Katakana
Caracteres Katakana
Caracteres Katakana
Катакана

Arabic numerals
Arabische Zahlen
Chiffres arabes
Arabische cijfers
Numeri arabi
Numeración arábiga
Números arábigos
Арабские цифры

Kanji characters often used in daily life.
Im täglichen Leben oft verwendete Kanji-Zeichen.
Caractères Kanji : souvent utilisés dans la vie de tous les jours.
Kanji-tekens worden vaak gebruikt in het dagelijks leven.
Caratteri Kanji utilizzati spesso nella vita di tutti i giorni.
Caracteres Kanji utilizados a menudo en el día a día.
Caracteres Kanji utilizados normalmente no día a día.
Иероглифы кандзи, часто используемые в повседневной жизни.

- Example of Kanji characters in daily life
- Beispiel für alltägliche Kanji-Zeichen
- Exemple de caractères Kanji dans la vie quotidienne
- Voorbeeld van Kanji-tekens in het dagelijks leven
- Esempio di caratteri kanji nella vita di ogni giorno
- Ejemplo de caracteres Kanji en la vida cotidiana
- Exemplo de caracteres Kanji no dia a dia
- Примеры использования иероглифов кандзи в повседневной жизни

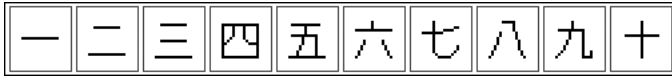

1, 2, 3, 4, 5, 6, 7, 8, 9, 10

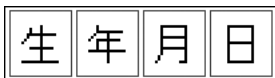

Date of birth
Data di nascita

Geburtsdatum
Fecha de nacimiento

Date de naissance
Data de nascimento

Geboortedatum
Дата рождения

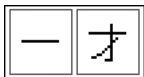

1 year old
1 anno di età

1 Jahr alt
1 año de edad

1 an
1 ano

1 jaar oud
Возраст 1 год



Nursery school
Asilo nido

Vorschule
Guardería

Crèche
Escola maternal

Peuterspeelzaal
Ясли



Kindergarten
Scuola materna

Kindergarten
Jardín de infancia

École maternelle
Jardim de infância

Kleuterschool
Детский сад



Elementary school
Scuola elementare

Grundschule
Escuela primaria

École primaire
Ensino básico

Basisschool
Начальная школа



Junior high school
Scuola superiore

Realschule
Escuela secundaria

Collège
Ensino médio

Middelbare school
Средняя школа



Group/Class
Gruppo/classe

Gruppe/Klasse
Grupo/Clase

Groupe/Classe
Grupo/Classe

Groep/klas
Группа, класс



Club/Division
Club/sezione

Club/Abteilung
Club/División

Club/Division
Clube/Divisão

Club/Divisie
Клуб, подразделение



Moon/Monday
Luna/lunedì

Mond/Montag
Luna/Lunes

Lune/Lundi
Lua/Segunda-feira

Maan/Maandag
Луна, понедельник



Fire/Tuesday
Fuoco/martedì

Feuer/Dienstag
Fuego/Martes

Feu/Mardi
Fogo/Terça-feira

Vuur/Dinsdag
Огонь, вторник



Water/Wednesday
Acqua/mercoledì

Wasser/Mittwoch
Agua/Miércoles

Eau/Mercredi
Água/Quarta-feira

Water/Woensdag
Вода, среда



Tree/Thursday
Albero/giovedì

Baum/Donnerstag
Árbol/Jueves

Arbre/Jeudi
Árvore/Quinta-feira

Boom/Donderdag
Дерево, четверг



Gold/Friday
Oro/venerdì

Gold/Freitag
Oro/Viernes

Or/Vendredi
Ouro/Sexta-feira

Goud/Vrijdag
Золото, пятница



Soil/Saturday
Terra/sabato

Erde/Samstag
Tierra/Sábado

Terre/Samedi
Terra/Sábado

Grond/Zaterdag
Земля, суббота



Sun/Sunday
Sole/domenica

Sonne/Sonntag
Sol/Domingo

Soleil/Dimanche
Sol/Domingo

Zon/Zondag
Солнце, воскресенье



January 1st (Monday)
1° gennaio (lunedì)

1. Januar (Montag)
1 de enero (lunes)

1er janvier (lundi)
1° de janeiro (Segunda-feira)

1 januari (maandag)
1 января (понедельник)

English
German
French
Dutch
Italian
Spanish
Portuguese-BR
Russian
888-F50/F52
Printed in Vietnam



XG0534-101①