

Register your product and get support at
www.saeco.com/welcome

02

English

EXPRESLIA EVO

Type HD8858 / HD8859

USER MANUAL



EN

02

PLEASE READ THIS USER MANUAL CAREFULLY BEFORE USING THE MACHINE.

CE

 **Saeco**

IMPORTANT SAFEGUARDS

When using electrical appliances, basic safety precautions should always be followed, including the following:

1. Read all instructions.
2. Do not touch hot surfaces. Use handles or knobs.
3. To protect against fire, electric shock and injury to persons do not immerse cord, plugs, or appliance in water or other liquid.
4. Close supervision is necessary when the appliance is used by or near children.
5. Unplug from outlet when not in use and before cleaning. Allow to cool before putting on or taking off parts, and before cleaning the appliance.
6. Do not operate any appliance with a damaged cord or plug or after the appliance malfunctions, or has been damaged in any manner. Return appliance to the nearest authorized service facility for examination, repair or adjustment.
7. The use of accessory attachments not recommended by the appliance manufacturer may result in fire, electric shock or injury to persons.
8. Do not use outdoors.
9. Do not let cord hang over edge of table or counter, or touch hot surfaces.
10. Do not place on or near a hot gas or electric burner, or in a heated oven.
11. Always attach plug to appliance first, then plug cord into wall outlet. To disconnect, turn any control to "off", then remove plug from wall outlet.
12. Do not use appliance for other than intended use.
13. Save these instructions.

SAVE THESE INSTRUCTIONS

CAUTION

This appliance is for household use only. Any servicing, other than cleaning and user maintenance, should be performed by an authorized service center. Do not immerse machine in water. To reduce the risk of fire or electric shock, do not disassemble the machine. There are no parts inside the machine serviceable by the user. Repair should be done by authorized service personnel only.

1. Check voltage to be sure that the voltage indicated on the nameplate corresponds with your voltage.
2. Never use warm or hot water to fill the water tank. Use cold water only.
3. Keep your hands and the cord away from hot parts of the appliance during operation.
4. Never clean with scrubbing powders or harsh cleaners. Simply use a soft cloth dampened with water.
5. For optimal taste of your coffee, use purified or bottled water. Periodic descaling is still recommended every 2-3 months.
6. Do not use caramelized or flavored coffee beans.

INSTRUCTIONS FOR THE POWER SUPPLY CORD

- A. A short power-supply cord (or detachable power-supply cord) is to be provided to reduce risks resulting from becoming entangled in or tripping over a longer cord.
- B. Longer detachable power-supply cords or extension cords are available and may be used if care is exercised in their use.
- C. If a long detachable power-supply cord or extension cord is used,
 1. The marked electrical rating of the detachable power-supply cord or extension cord should be at least as great as the electrical rating of the appliance
 2. If the appliance is of the grounded type, the extension cord should be a grounding-type 3-wire cord, and
 3. The longer cord should be arranged so that it will not drape over the counter top or table top where it can be pulled on by children or tripped over.

Congratulations on your purchase of a Saeco Exprelia EVO fully automatic coffee machine!

To fully benefit from the support that Saeco offers, please register your product at www.saeco.com/welcome.

This user manual applies to HD8858 and HD8859.

The machine is suitable for preparing espresso coffee using whole coffee beans, and it is supplied with a milk carafe to prepare a perfect Cappuccino or Latte Macchiato in a quick and easy way. In this user manual you will find all the information you need to install, use, clean and descale your machine.

CONTENTS

IMPORTANT.....	4
Safety Instructions.....	4
Warnings.....	4
Cautions.....	6
Electromagnetic Fields.....	7
Disposal.....	7
INSTALLATION.....	8
Product Overview.....	8
General Description.....	9
PREPARING FOR USE.....	10
Machine Packaging.....	10
Machine Installation.....	10
USING THE MACHINE FOR THE FIRST TIME.....	13
Automatic Rinse/Self-Cleaning Cycle.....	13
Manual Rinse Cycle.....	14
MEASURING AND PROGRAMMING WATER HARDNESS.....	16
AQUACLEAN WATER FILTER.....	18
Preparing and Installing the AquaClean Filter.....	18
Activating the AquaClean Filter.....	19
Replacing the AquaClean Filter.....	21
Information on Filter Capacity.....	21
How to Replace the Filter.....	22
Replacing the Filter after Using 8 Filters.....	23
ADJUSTMENTS.....	24
Saeco Adapting System.....	24
Adjusting the Ceramic Coffee Grinder.....	24
Adjusting the Crema and Coffee Strength (Saeco Brewing System).....	25
Adjusting the Aroma (Coffee Strength).....	26

Adjusting the Dispensing Spout.....	26
Adjusting the Coffee Length	28
BREWING ESPRESSO, COFFEE AND LONG COFFEE	29
Brewing Espresso, Coffee and Long Coffee Using Coffee Beans	29
Brewing Espresso, Coffee and Long Coffee Using Pre-Ground Coffee.....	30
MILK CARAFE.....	32
Filling the Milk Carafe	32
Inserting the Milk Carafe	33
Removing the Milk Carafe.....	34
Emptying the Milk Carafe	35
BREWING A CAPPUCCINO	36
Adjusting the Cappuccino Length	38
BREWING LATTE MACCHIATO	39
Adjusting the Latte Macchiato Length	41
SPECIAL BEVERAGES	42
Hot Milk.....	43
Hot Water Dispensing	44
Brewing a Strong Coffee	45
Espresso Macchiato.....	46
Flat White	47
BEVERAGE PROGRAMMING	48
Cappuccino Programming	49
Hot Water Programming.....	51
MACHINE PROGRAMMING	52
AquaClean Filter	52
Settings Menu	53
Maintenance Menu.....	54
Statistics Menu	54
CLEANING AND MAINTENANCE	55
Daily Cleaning of the Machine	55
Daily Cleaning of the Water Tank.....	56
Daily Cleaning of the Milk Carafe: "CLEAN" Self-cleaning Cycle (After Each Use).....	57
Weekly Cleaning of the Machine	57
Weekly Cleaning of the Milk Carafe	59
Weekly Cleaning of the Brew Group.....	61
Monthly Cleaning of the Milk Carafe.....	64
Monthly Lubrication of the Brew Group.....	67
Monthly Cleaning of the Brew Group with "Coffee Oil Remover".....	68
Monthly Cleaning of the Coffee Bean Hopper	70
DESCALING.....	71
Interruption of the Descaling Cycle.....	76
MEANING OF THE DISPLAY.....	77
TROUBLESHOOTING	79
ENERGY SAVING.....	82
Stand-by.....	82
Screen Saver	82
TECHNICAL SPECIFICATIONS	83
WARRANTY AND SERVICE	83
Warranty	83
Service.....	83
ORDERING MAINTENANCE PRODUCTS	84

IMPORTANT

Safety Instructions

This machine is equipped with safety devices. Nevertheless, read and follow the safety instructions carefully and only use the machine properly as described in these instructions to avoid accidental injury or damage due to improper use of the machine. Keep this user manual for future reference.



The term **WARNING** and this icon warn against possible severe injuries, danger to life and/or damage to the machine.



The term **CAUTION** and this icon warn against slight injuries and/or damage to the machine.

Warnings

- Connect the machine to a wall socket with a voltage matching the technical specifications of the machine.
- Connect the machine to an earthed wall socket.
- Do not let the power cord hang over the edge of a table or counter, or touch hot surfaces.
- Never immerse the machine, the mains plug or power cord in water: Danger of electrical shock!
- Do not pour liquids on the power cord connector.
- Never direct the hot water jet towards body parts: Danger of burning!
- Do not touch hot surfaces. Use handles and knobs.
- After switching off the machine by pressing the power button on the back of the machine, remove the mains plug from the wall socket:
 - if a malfunction occurs;

- If the machine will not be used for a long time;
- before cleaning the machine.
- Pull on the mains plug, not on the power cord.
- Do not touch the mains plug with wet hands.
- Do not use the machine if the mains plug, the power cord or the machine itself is damaged.
- Do not make any modifications to the machine or its power cord. Only have repairs carried out by a service centre authorised by Philips to avoid any hazard.
- The machine should not be used by children younger than 8 years old.
- The machine can be used by children of 8 years and upwards if they have previously been instructed on the correct use of the machine and made aware of the associated dangers or if they are supervised by an adult.
- Cleaning and maintenance should not be carried out by children unless they are more than 8 years old and supervised by an adult.
- Keep the machine and its power cord out of reach of children under 8 years old.
- The machine may be used by persons with reduced physical, sensory or mental capabilities or lacking sufficient experience and/or skills if they have previously been instructed on the correct use of the machine and made aware of the associated dangers or if they are supervised by an adult.
- Children should be supervised to ensure that they do not play with the machine.
- Never insert fingers or other objects into the coffee grinder.

Cautions

- The machine is for household use only. It is not intended for use in environments such as canteens, staff kitchens of shops, offices, factories or other work environments.
- Always put the machine on a flat and stable surface.
- Do not place the machine on hot surfaces, directly next to a hot oven, heater units or similar sources of heat.
- Only put roasted coffee beans into the coffee bean hopper. If ground coffee, instant coffee, raw coffee or any other substance is put in the coffee bean hopper, it may damage the machine.
- Let the machine cool down before inserting or removing any parts. The heating surfaces may retain residual heat after use.
- Never use warm or hot water to fill the water tank. Use only cold non-sparkling drinking water.
- Never clean with scrubbing powders or harsh cleaners. Simply use a soft cloth dampened with water.
- Descale your machine regularly. Not doing this will make your appliance stop working properly. In this case, repair is not covered under your warranty!
- Do not keep the machine at temperature below 0 °C. Residue water in the heating system may freeze and cause damage.
- Do not leave water in the water tank if the machine is not used over a long period of time. The water can get contaminated. Use fresh water every time you use the machine.

Electromagnetic Fields

This appliance complies with all the applicable standards and regulations relating to the exposure to electromagnetic fields.

Disposal



This symbol on a product indicates that the product is covered by EU Directive 2012/19/EU. Please inform yourself about the local separate collection system for electrical and electronic products. Follow local regulations and do not dispose of the product as household waste. Appropriate disposal of old products helps prevent negative consequences for the environment and human health.

INSTALLATION

Product Overview

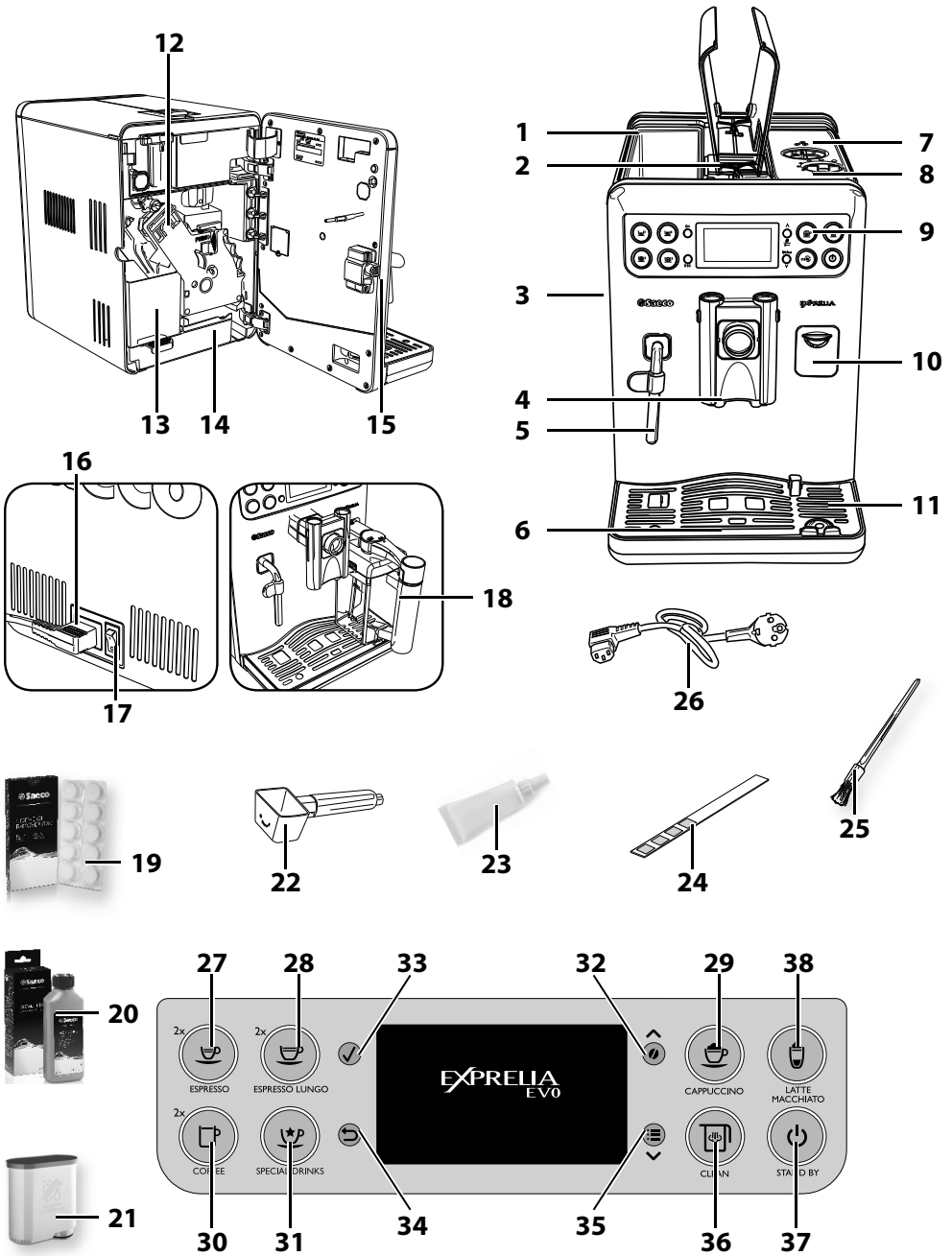

General Description

1. Water tank
2. Pre-ground coffee compartment
3. Service door
4. Coffee dispensing spout
5. Steam/hot water wand
6. Full drip tray indicator
7. Coffee bean hopper with lid
8. Coffee grinder adjustment
9. Control panel
10. Carafe coupling cap
11. Drip tray (external)
12. Brew group
13. Coffee grounds drawer
14. Drip tray (internal)
15. Service door button
16. Power cord socket
17. Power button
18. Milk carafe
19. Coffee Oil Remover (to be purchased separately)
20. Descaling solution (optional)
21. AquaClean filter (optional)
22. Pre-ground coffee measuring scoop
23. Grease for the brew group
24. Water hardness test strip
25. Cleaning brush
26. Power cord
27. "Espresso" button
28. "Espresso Lungo" button
29. "Cappuccino" button
30. "Coffee" button
31. "Special Drinks" button
32. "Aroma" - Pre-ground coffee button
33. "OK" button
34. "ESC" button
35. "MENU" button
36. "Clean" button - To carry out a carafe cleaning cycle
37. "Stand-by" button
38. "Latte Macchiato" button

PREPARING FOR USE

Machine Packaging

The original packaging has been designed and constructed to protect the machine during transport. We recommend keeping the packaging material for possible future transport.

Machine Installation

1 Remove the drip tray with grill from the packaging.

2 Remove the machine from the packaging.

3 For best use, it is recommended to:

- Choose a safe, level surface, where there will be no danger of overturning the machine or being injured.
- Choose a location that is sufficiently well-lit, clean and near an easily reachable socket.
- Allow for a minimum distance from the sides of the machine as shown in the figure.

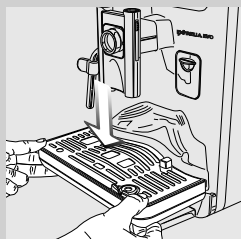
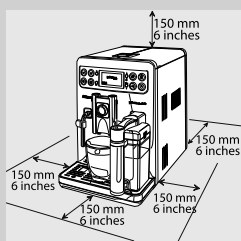

4 Insert the (external) drip tray with grill into the machine. Make sure it is correctly placed.



Note:

The drip tray collects the water that comes out of the dispensing spout during each rinse/self-cleaning cycle, as well as coffee that might be spilled during beverage preparation. Empty and wash the drip tray daily and each time the full drip tray indicator is raised.

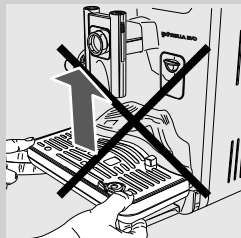

Caution:

NEVER remove the drip tray when the machine has just been turned on. Wait a couple of minutes for the machine to carry out a rinse/self-cleaning cycle.

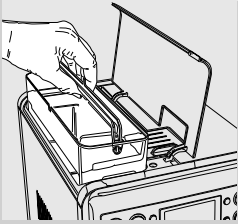

- 5** Lift the lid and remove the water tank using the handle.

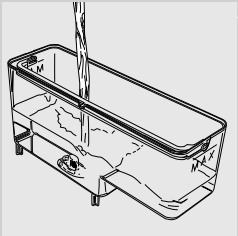

- 6** Rinse the water tank with fresh water.

- 7** Fill the water tank with fresh water up to the MAX level and put it back into the machine. Make sure it is fully inserted.

! **Caution:**

Never fill the water tank with warm, hot, sparkling water or any other liquid, as this may cause damage to the water tank and the machine.

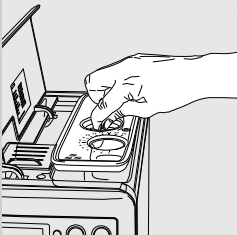

- 8** Lift the coffee bean hopper lid and remove the inner lid.



- 9** Slowly pour the coffee beans into the hopper. Refit the inner lid and close the outer one.

≡ **Note:**

Do not pour too many coffee beans into the coffee bean hopper as this will reduce the grinding performance of the machine.

! **Caution:**

Only coffee beans must be put into the coffee bean hopper. If ground coffee, instant coffee, caramelized coffee, raw coffee beans or any other substance is put in the coffee bean hopper, it may damage the machine.

12 ENGLISH

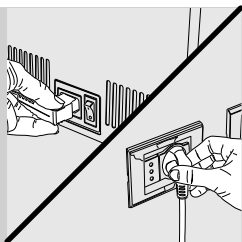

10 Insert the plug into the socket located on the back of the machine.

11 Insert the plug on the other end of the power cord into a wall socket with suitable power voltage.

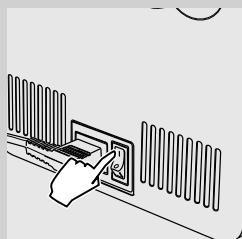

12 Switch the power button to "I" to turn on the machine.



13 This screen is displayed. Select the desired language by pressing the "✓" or "∧" scrolling button.



14 Press the "✓" button to confirm.

 **Note:**

If no language is selected, you will be requested to select it the next time the machine is started.



15 The machine is warming up.

USING THE MACHINE FOR THE FIRST TIME

Automatic Rinse/Self-Cleaning Cycle

When warm-up has been completed, the machine automatically performs a rinse/self-cleaning cycle of the internal circuits with fresh water. This takes less than a minute.



- 16** Place a container under the dispensing spout to catch the small amount of water which will be dispensed.

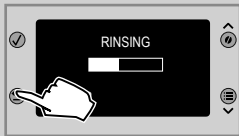

- 17** This screen is displayed. Wait for the cycle to finish automatically.

Note:

You can stop dispensing by pressing the "D" button.

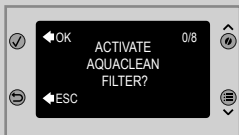

- 18** When the operations described above have been completed, the machine shows this display.

Manual Rinse Cycle

You need to perform a rinse cycle when using the machine for the first time. During this process, the coffee brewing cycle is activated and fresh water flows through the dispensing spout. This takes a few minutes.

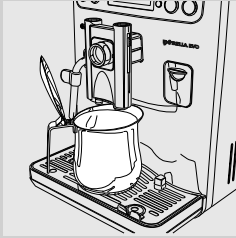

- 1 Place a container under the dispensing spout.

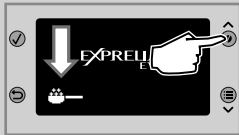

- 2 Select the pre-ground coffee brewing function by pressing the "☰" button until the "☰☰☰" icon is displayed.



- 3 Press the "☰☰☰" button.

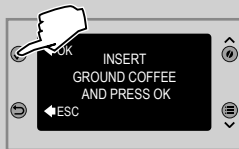

- 4 Press the "✓" button. The machine starts dispensing water.

Note:

Do not add pre-ground coffee into the compartment.

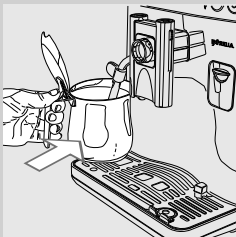



- 5 When dispensing has been completed, empty the container and place it back under the steam/hot water wand.



6 Press the “” button.



7 Press the “” button to scroll down the options. Press the “” button to select HOT WATER.

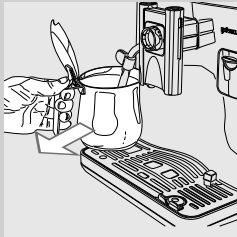

8 After dispensing water, remove and empty the container.

9 Repeat the steps from 5 to 8 until the water tank is empty, then continue with step 10.

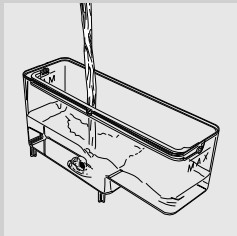

10 At the end of this operation, fill the water tank again up to the MAX level. Now the machine is ready to brew coffee.

 **Note:**

When you have not used the machine for two or more weeks, the machine will automatically perform an automatic rinse/self-cleaning cycle after you turn it on. Following this, you need to perform a manual rinse cycle as described above.

The automatic rinse/self-cleaning cycle is also initiated automatically when starting up the machine (with a cold boiler), when the machine is preparing to go into stand-by mode or after pressing the “” button to turn off the machine (after a coffee has been brewed).

MEASURING AND PROGRAMMING WATER HARDNESS

Measuring water hardness is essential for preserving coffee flavour. To measure water hardness, follow the steps below.

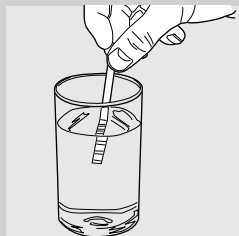

- 1 Immerse the water hardness test strip supplied with the machine in water for 1 second.



Note:

The test strip can only be used for one single measurement.

- 2 Wait for one minute.

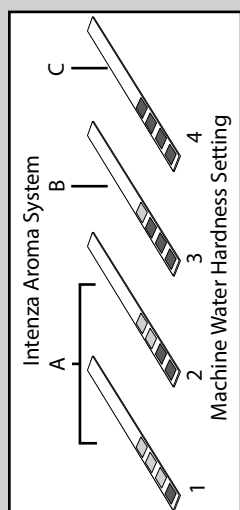

- 3 Check how many squares have changed to red, then refer to the table.



Note:

The numbers on the water hardness test strip correspond to the water hardness adjustment settings.

More precisely:

- 1 = 1 (very soft water)
- 2 = 2 (soft water)
- 3 = 3 (hard water)
- 4 = 4 (very hard water)

The letters correspond to the references that are located at the base of the AquaClean filter (see next chapter).





- 4 Now you can program the water hardness setting. Press the “☰” button to access the machine main menu.



Note:

The machine is supplied with a standard water hardness setting, suitable for most types of water.



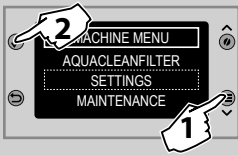

5 Press the “” button to scroll down the options. Press the “” button to select MACHINE MENU.

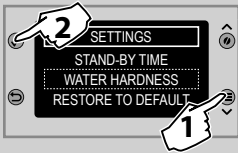

6 Press the “” button to select SETTINGS. Press “” to confirm.



7 Press the “” button to select the WATER HARDNESS option. Press “” to confirm.

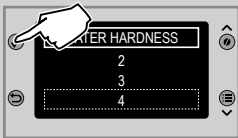

8 Press the “” button or the “” button to select the WATER HARDNESS value and press the “” button to confirm.



9 Press the “” button one or more times to go back to the main menu.

AQUACLEAN WATER FILTER



The AquaClean filter is designed to reduce limescale build-up inside the machine and to provide filtered water in order to preserve the coffee aroma and flavour in each cup. By using the series of 8 AquaClean filters as indicated in this user manual, you will not need to descale the machine for 2 years or for the next 5000 cups (with 100-ml capacity).



Note:

Replace the AquaClean filter when the filter icon on the display starts flashing. Replace the AquaClean filter at least each 3 months, even if the machine is yet to inform you that it needs to be replaced.

After the machine has been used for a given time, it will require the filter to be replaced. This will allow you to replace the filter 8 times (equal to about 5000* beverages!) before having to descale the machine.

(*) Using 100-ml cups.

Preparing and Installing the AquaClean Filter



- 1 Remove the AquaClean filter from its packaging. Shake it for about 5 seconds. Immerse the AquaClean filter upside down in a carafe full of cold water and wait for the air bubbles to come out.

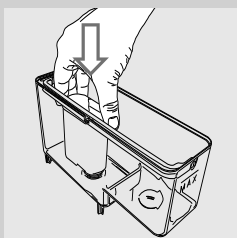

- 2 Put the AquaClean filter into the empty water tank. You can leave the small water filter in place. Press the AquaClean filter down until it cannot move any further.

Activating the AquaClean Filter

You can install the AquaClean filter when first installing the machine as part of the overall installation procedure. If you did not install the AquaClean filter upon first use, you can install it later by accessing the menu as described here below.



- 1 Press the “☰” button to access the machine main menu.

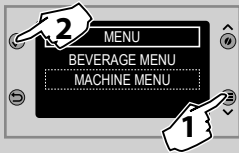

- 2 Press the “↘” button and the “↙” button to select MACHINE MENU.



- 3 Press the “↙” button to select AQUACLEAN FILTER.

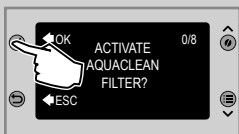

- 4 The display shows the number of AquaClean filters previously installed, from 0 to 8. The display asks you if you wish to activate the filter. Press the “↘” button to confirm the filter activation procedure.

Note:

If you do not wish to activate the filter, exit the menu by pressing the “↩” button.

Note:

The number of filters previously installed is displayed in the upper right-hand corner of the screen. In this case, the screen indicates that the filter being installed is the first one. This number is very important: after the

eighth filter (when the display shows **8/8**), the machine will require a descaling cycle to be performed when installing the next filter.

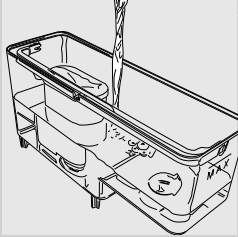

- 5** The display is prompting you to insert the filter and to fill the water tank. Prepare the AquaClean filter and place it inside the water tank (refer to "Preparing and Installing the AquaClean Filter"). Fill the water tank up to the MAX level.

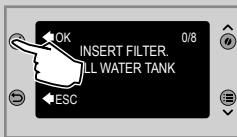

- 6** Press the "✓" button to confirm that you have inserted the water filter and filled the water tank.

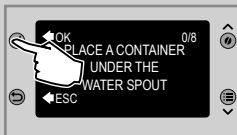

- 7** Press the "✓" button to confirm that a container is placed under the water dispensing spout.



- 8** The machine starts dispensing water. This screen will be displayed. At the end of the operation, remove the container.

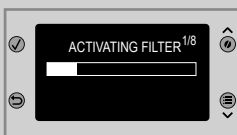



- 9** When the operations described above have been completed, the machine shows this display. The icon shows the capacity of the AQUACLEAN filter that you have just installed. The 100% AquaClean icon appears on the machine-ready screen to indicate that the filter has been activated.

Replacing the AquaClean Filter

Replace the AquaClean filter when the filter icon on the display starts flashing.

Information on Filter Capacity



- 1** When installing a new filter, the status indication on top of the filter icon is 100%.



- 2** This percentage gradually decreases from 100% to 20% with use.



- 3** When filter capacity drops below 10%, the filter icon flashes on and off for 2 seconds. This indicates that filter performance has decreased to the point where the filter needs to be removed and replaced with a new one.



- 4 If you do not replace the filter, the filter icon flashes on and off for 1 second when filter capacity drops to 0%. If you ignore this warning, the display will not show the filter icon anymore.



- 5 If the filter icon is not displayed anymore, you will need to descale the machine before installing a new filter.



Caution:

If the filter is not replaced promptly, the machine will require a descaling cycle to be performed.

How to Replace the Filter



- 1 Press the "☰" button to access the machine main menu. Press the "✓" button and the "✓" button to select MACHINE MENU. Press the "✓" button to select AQUACLEAN FILTER.



- 2 The display shows the number of AquaClean filters previously installed, from 0 to 8. The display asks you if you wish to activate a new filter. Press the "✓" button to confirm.

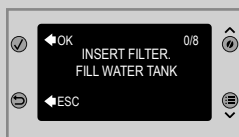

- 3 Follow the instructions shown on the display to install a new filter, fill the water tank and insert the hot water dispensing spout. Press the "✓" button to confirm each step.

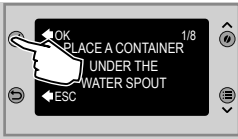

4 Press the “✓” button to confirm that you have placed a container under the water dispensing spout.

5 A bar showing the filter activation progress status is displayed on the filter activation screen.



6 When the operations described above have been completed, the machine shows this display. The 100% AquaClean icon appears on the machine-ready screen to indicate that the filter has been activated.



Caution:

If the filter used is the last one of the 8-filter series, the machine will ask for descaling before activating a new filter. Refer to the chapter relating to machine descaling.

Replacing the Filter after Using 8 Filters



1 When the filter icon on the display starts flashing, press the “☰” button to access the machine main menu.

Press the “✓” button and the “✓” button to select MACHINE MENU. Press the “✓” button to select AQUACLEAN FILTER.

2 The display indicates that you need to descale the machine before activating a new filter. Press the “✓” button to start the descaling procedure.



Note:

If you do not wish to start the descaling procedure right now, press the “↶” button to exit the filter menu.

3 When the descaling procedure has been completed, the display asks you if you wish to install the AquaClean filter. Follow the steps described under "Replacing the AquaClean Filter". Replace the filter as described in the previous section.



ADJUSTMENTS

The machine allows for certain adjustments so that you can brew the best tasting coffee possible.

Saeco Adapting System

Coffee is a natural product whose characteristics may change according to its origin, blend and roast. The machine is equipped with a self-adjusting system allowing you to use all types of coffee beans available on the market (except for caramelized beans).

The machine automatically adjusts itself after brewing several cups of coffee in order to optimise extraction in relation to the compactness of ground coffee.

Adjusting the Ceramic Coffee Grinder

Ceramic coffee grinders guarantee accurate grinding for every coffee blend and prevent the beans from overheating.

This provides full aroma preservation, delivering a truly Italian taste in every cup.



Warning:

The ceramic coffee grinder contains moving parts that may be dangerous. Do not insert fingers or any other objects. Turn off the machine by pressing the ON/OFF button and remove the plug from the socket before carrying out any type of operation inside the coffee bean hopper.

You can adjust the ceramic grinders to set coffee grinding to your personal taste.



Warning:

The grinder adjustment knob inside the coffee bean hopper must be turned only when the ceramic coffee grinder is in use.

This adjustment can be carried out by pressing and turning the grinder adjustment knob inside the coffee bean hopper.

- 1 Lift the coffee bean hopper lid.

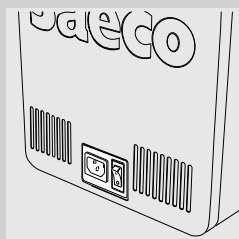

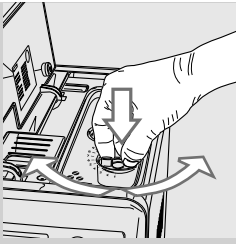

2 Press and turn the grinder adjustment knob one notch at a time. You will taste the difference after brewing 2-3 cups of espresso.

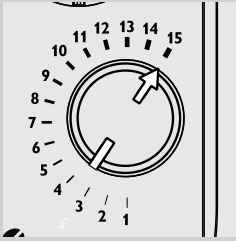

3 The reference marks on the coffee bean hopper lid indicate the grind setting. There are 15 different grind settings to choose from, from:

- very coarse grind (15): lighter taste, for dark roasted coffee blends;
- to:
- very fine grind (1): stronger taste, for light roasted coffee blends.

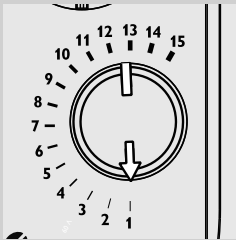

When you adjust the ceramic coffee grinder to a finer setting, your coffee will taste stronger. For a lighter coffee taste, adjust the ceramic coffee grinder to a coarser setting.

Adjusting the Crema and Coffee Strength (Saeco Brewing System)

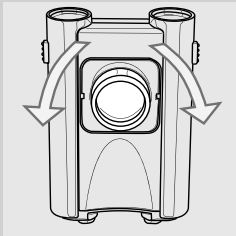

The Saeco Brewing System (SBS) allows you to control the coffee crema and flavour intensity by adjusting the coffee brewing speed.

- Turn the knob to (●) to increase the flow rate: coffee becomes lighter and has less crema.
- Turn the knob to (◐) to decrease the flow rate: coffee becomes stronger and has more crema.

Note:

The speed can be adjusted while brewing coffee.

Adjusting the Aroma (Coffee Strength)

Choose your favourite coffee blend and adjust the amount of coffee to be ground according to your own taste. You can also select the pre-ground coffee function.



Note:

Selection must be made prior to selecting coffee.

The machine allows you to set the right quantity of ground coffee for each product. The standard adjustment for each product can be set in the "BEVERAGE MENU" (see the "Beverage Programming" chapter, "Coffee Amount" option).

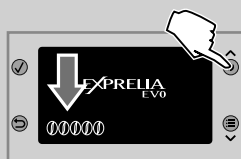
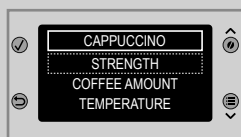

1 To temporarily change the amount of ground coffee, press the "0" button on the control panel.

2 The aroma changes by one degree, according to the selected amount:

- 0** = VERY MILD
- 00** = MILD
- 000** = REGULAR
- 0000** = STRONG
- 00000** = VERY STRONG
-  = the beverage is brewed using pre-ground coffee

Adjusting the Dispensing Spout

The height of the dispensing spout may be adjusted to better fit the size of the cups that you wish to use.

Move the dispensing spout up or down with your fingers to adjust its height as shown in the figure.

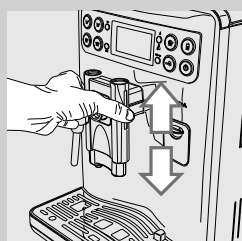



The recommended positions are:
For small cups;

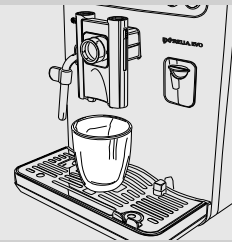

For large cups;

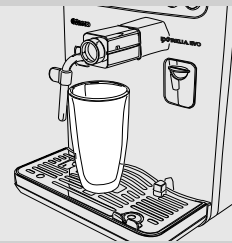

For Latte Macchiato cups.



Note:

The dispensing spout can also be removed to allow the use of large containers.

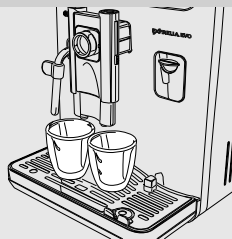

Two cups can be placed under the dispensing spout to brew two coffees at the same time.

Adjusting the Coffee Length

The machine allows you to adjust the amount of brewed coffee or milk according to your taste and the size of your cups.

Each time the “☺”, “☺” and “☺” buttons are pressed, the machine brews a pre-set amount of product. Each button may be individually programmed for a specific brew setting.

The following procedure describes how to program the “☺” button.



- 1 Place a cup under the coffee dispensing spout.



- 2 Press and hold the “☺” button until the “MEMO” icon is displayed. Then release the button. The machine is now in programming mode. The machine starts brewing coffee.



- 3 When the “STOP” icon is displayed, press the “☺” button as soon as the desired amount of coffee is reached.

Now the “☺” button is programmed; each time it is pressed, the machine will brew the same amount of espresso that was just programmed.



Note:

Follow the same procedure to program the “☺” and “☺” buttons. Always use the “STOP” button to stop brewing when the desired amount of coffee is reached.

You can also adjust the beverage length through the “BEVERAGE MENU” (see the “Beverage Programming” chapter, “Coffee Length” option).

BREWING ESPRESSO, COFFEE AND LONG COFFEE

Before brewing coffee, make sure that there are no warnings shown on the display and that the water tank and coffee bean hopper are filled.

Brewing Espresso, Coffee and Long Coffee Using Coffee Beans

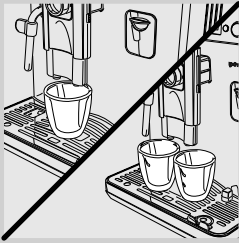

- 1 Place 1 or 2 cups under the dispensing spout.



- 2 Press the “☕” button for an espresso, the “☕” button for a coffee or the “☕” button for a long coffee.

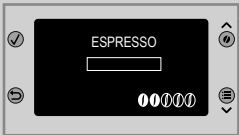

- 3 To brew 1 ESPRESSO, 1 LONG ESPRESSO or 1 CLASSIC COFFEE, press the desired button once. This screen will be displayed.

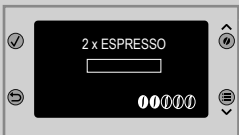

- 4 To brew 2 CUPS OF ESPRESSO, 2 cups of coffee or 2 CUPS OF LONG ESPRESSO, press the desired button twice consecutively. This screen will be displayed.

Note:

In this operating mode, the machine automatically grinds and doses the proper amount of coffee. Brewing two cups of espresso requires two grinding and brewing cycles, automatically carried out by the machine.



- 5 After the prebrewing cycle, coffee begins to pour out of the dispensing spout.



- 6 Coffee brewing stops automatically when the set level is reached; however, it is possible to stop it earlier by pressing the “⏏” button.

Brewing Espresso, Coffee and Long Coffee Using Pre-Ground Coffee

This function allows you to use pre-ground and decaffeinated coffee. With the pre-ground coffee function you can only brew one coffee at a time.

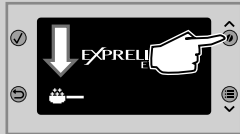

- 1 To select the pre-ground coffee function, keep the “→” button pressed until the “☕” icon is displayed as a display function.

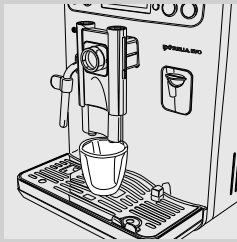

- 2 Place a cup under the dispensing spout.



- 3 Press the “☕” button for an ESPRESSO, the “☕” button for a LONG ESPRESSO or the “☕” button for a CLASSIC COFFEE. The brewing cycle starts.

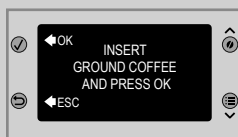

- 4 This screen will be displayed.

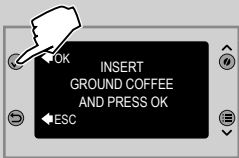
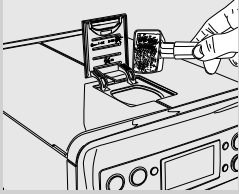

- 5 Lift the pre-ground coffee compartment lid and add one measuring scoop of pre-ground coffee to the compartment. Use only the measuring scoop supplied with the machine. Then close the pre-ground coffee compartment lid.

**Warning:**

Add only pre-ground coffee to the pre-ground coffee compartment. Other substances and objects may cause severe damage to the machine. Such damage will not be covered by warranty.

- 6 Press “✓” to confirm and start brewing.

- 7 After the prebrewing cycle, coffee begins to pour out of the dispensing spout.

- 8 Coffee brewing stops automatically when the set level is reached; however, it is possible to stop it earlier by pressing the “↶” button.

After brewing, the machine returns to the main menu.

Repeat the steps described above to brew more cups of coffee using pre-ground coffee.

**Note:**

If the “✓” brewing start button is not pressed within 30 seconds, the machine will return to the main menu and discharge any coffee into the coffee grounds drawer.

If no pre-ground coffee is poured into the compartment, only water will be dispensed.

If the dose is excessive or 2 or more measuring scoops of coffee are used, the machine will not brew the product. Only water will be dispensed and the ground coffee will be discharged into the coffee grounds drawer.

MILK CARAFE

This chapter explains how to use the milk carafe to prepare a cappuccino, a Latte Macchiato or hot milk.



Note:

Before using the milk carafe, clean it thoroughly as described in the “Cleaning and Maintenance” chapter.

We recommend filling it with cold milk (approx. 5°C). After use, put the carafe back in the refrigerator. DO NOT leave milk out of the refrigerator for more than 15 minutes.



Warning:

Only put milk or water for cleaning in the carafe.

Filling the Milk Carafe

The milk carafe must be filled before use.



- 1 Open the milk carafe dispensing spout by turning it clockwise until it locks into place.

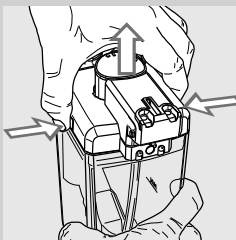

- 2 Press the release buttons and lift the lid.

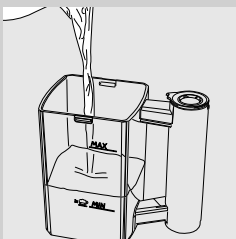

- 3 Pour milk into the carafe: the milk level must be between the minimum (MIN) and maximum (MAX) level indicators shown on the milk carafe.

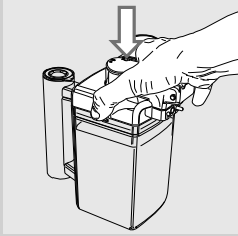

- 4** Refit the lid and close the milk carafe dispensing spout by turning it counter-clockwise.

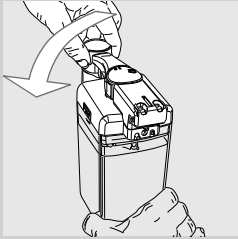

The milk carafe is now ready for use.

Inserting the Milk Carafe

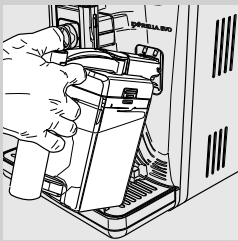

- 1** Slightly tilt the milk carafe and insert it in the front part of the machine.

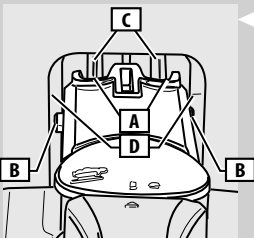

- 2** At this stage, the carafe holes (A) are lower than the couplings (C). The pins (B) are located at the same height as the guides (D).

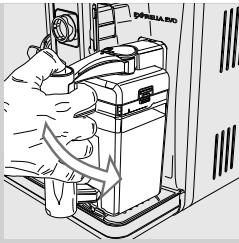

- 3 Push the carafe towards the bottom while rotating it at the same time until it is locked onto the (external) drip tray (E).



Caution:
Do not force the carafe while inserting it.

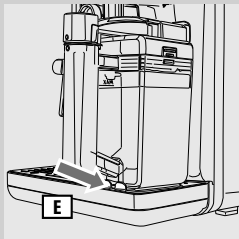

Removing the Milk Carafe

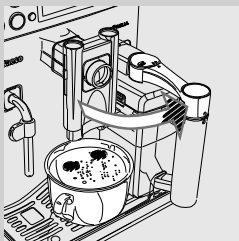

- 1 Close the milk carafe dispensing spout by turning it counter-clockwise.

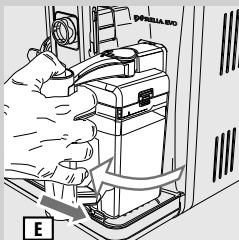

- 2 Turn the milk carafe upwards until it is released from the (external) drip tray (E).

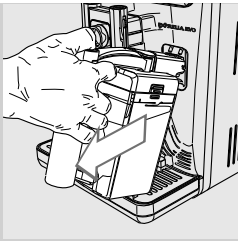

- 3 Pull it away from the machine until it is completely removed.

Emptying the Milk Carafe



- 1 Open the milk carafe dispensing spout by turning it clockwise.

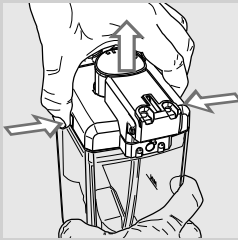

- 2 Press the release buttons to remove the lid.

- 3 Lift the lid. Empty the milk carafe and clean it properly.



Note:

After each use, clean the milk carafe as described in the "Cleaning and Maintenance" chapter.

BREWING A CAPPUCCINO



Warning:

Danger of burning! Dispensing may be preceded by jets of milk and steam.

Never seize the carafe handle during the cleaning cycle: danger of burning! Wait until the end of the cycle before removing the milk carafe.

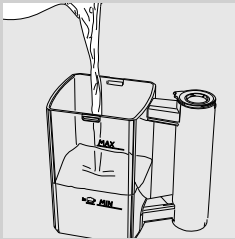

- 1 Fill the carafe with milk. The milk level must be between the minimum (MIN) and maximum (MAX) level indicators shown on the milk carafe.



Note:

Use cold (~5 °C / 41°F) milk with a protein content of at least 3% to ensure optimum results when preparing a cappuccino. Whole milk or skimmed milk may be used depending on individual taste.

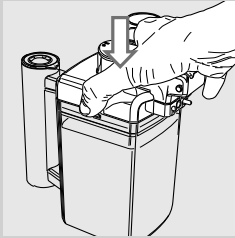

- 2 Refit the lid and insert the milk carafe into the machine.

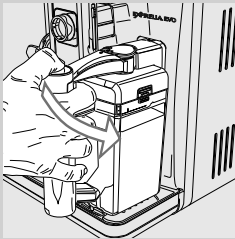

- 3 Place a cup under the coffee dispensing spout.

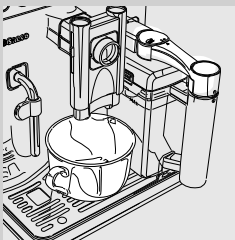

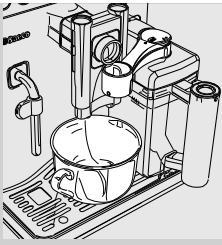

4 Open the milk carafe dispensing spout by turning it clockwise.



5 Press the "☕" button to start dispensing.



6 The machine is warming up.

Note:

If the ECOMODE function is active, the machine requires a longer waiting time for warm-up. For further details, please refer to the "Machine Programming" chapter.



7 When this screen is displayed, the machine starts dispensing frothed milk. Dispensing can be stopped earlier by pressing the "⏪" button.



8 Once the milk froth has been dispensed, the machine brews coffee. Brewing can be stopped earlier by pressing the "⏪" button.

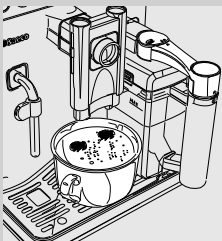

9 Remove the cup and close the milk dispensing spout by turning it counter clockwise.

10 Wait for a few seconds. Now the machine starts the automatic cleaning cycle (see the "Cleaning and Maintenance" chapter).

11 Wait until the end of the cleaning cycle, remove the milk carafe and place it in the refrigerator.

Refer to the "Special Beverages" chapter to prepare hot milk.

Adjusting the Cappuccino Length

Each time the “☕” button is pressed, the machine dispenses a pre-set quantity of cappuccino into the cup. The machine allows you to adjust the amount of cappuccino according to your taste and the size of your cups.

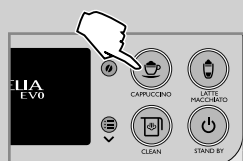

- 1 Fill the carafe with milk and place it into the machine.
- 2 Place a cup under the dispensing spout and open the carafe dispensing spout by rotating it clockwise.
- 3 Press and hold the “☕” button until the “MEMO” icon is displayed. Then release the button. The machine is now in programming mode.
- 4 The machine is warming up.
- 5 When this screen is displayed, the machine starts dispensing milk froth into the cup. Press the “↶” button as soon as the desired amount of milk is reached.
- 6 Once the milk froth has been dispensed, the machine starts brewing coffee. When the desired amount of coffee is reached, press the “↷” button.

The “☕” button is now programmed. Each time it is pressed, the machine will brew the same amount that was just programmed.



Note:

You can also adjust the beverage length through the BEVERAGE MENU (see the “Beverage Programming” chapter).

BREWING LATTE MACCHIATO**Warning:**

Danger of burning! Dispensing may be preceded by jets of milk and steam.

Never seize the carafe handle during the cleaning cycle: danger of burning! Wait until the end of the cycle before removing the milk carafe.

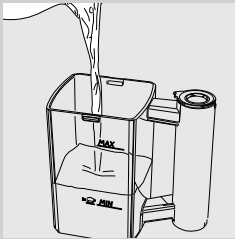

- 1 Fill the carafe with milk. The milk level must be between the minimum (MIN) and maximum (MAX) level indicators shown on the milk carafe.

**Note:**

Use cold (~5 °C / 41°F) milk with a protein content of at least 3% to ensure optimum results when preparing a cappuccino. Whole milk or skimmed milk may be used depending on individual taste.

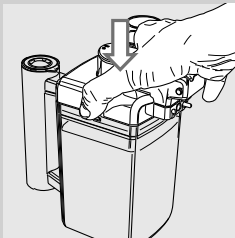

- 2 Refit the lid and insert the milk carafe into the machine.



- 3 Place a cup under the coffee dispensing spout.

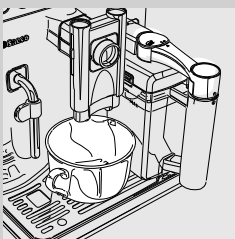

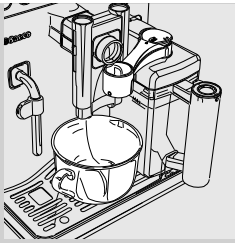

4 Open the milk carafe dispensing spout by turning it clockwise.



5 Press the “☕” button to start dispensing.



6 The machine is warming up.



Note:

If the ECOMODE function is active, the machine requires a longer waiting time for warm-up. For further details, please refer to the “Machine Programming” chapter.



7 When this screen is displayed, the machine starts dispensing frothed milk. Dispensing can be stopped earlier by pressing the “↶” button.



8 Once the milk froth has been dispensed, the machine brews coffee. Brewing can be stopped earlier by pressing the “↶” button.

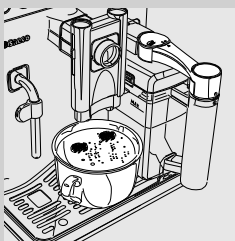

9 Remove the cup and close the milk dispensing spout by turning it counter clockwise.

10 Wait for a few seconds. Now the machine starts the automatic cleaning cycle (see the “Cleaning and Maintenance” chapter).

11 Wait until the end of the cleaning cycle, remove the milk carafe and place it in the refrigerator.

Adjusting the Latte Macchiato Length

Each time the “☕” button is pressed, the machine dispenses a pre-set quantity of Latte Macchiato into the cup. The machine allows you to adjust the amount of Latte Macchiato according to your taste and the size of your cups.

- 1 Fill the milk carafe with milk and insert it into the machine.
- 2 Place a cup under the dispensing spout and open the carafe dispensing spout by rotating it clockwise.



- 3 Press and hold the “☕” button until the “MEMO” icon is displayed, then release the button. The machine is now in programming mode.

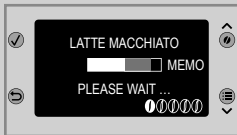

- 4 The machine is warming up.



- 5 When this screen is displayed, the machine starts dispensing milk froth into the cup. Press the “☕” button as soon as the desired amount of milk is reached.



- 6 Once the milk froth has been dispensed, the machine starts brewing coffee. When the desired amount of coffee is reached, press the “☕” button.

The “☕” button is now programmed. Each time it is pressed, the machine will brew the same amount that was just programmed.

Note:

You can also adjust the beverage length through the BEVERAGE MENU (see the “Beverage Programming” chapter).



SPECIAL BEVERAGES

The machine is designed to brew more products than those described above. For this, follow the steps below:



- 1 Press the “” button to access the SPECIAL BEVERAGES menu.



- 2 Select the desired beverage by pressing the “” or “” scrolling button.



- 3 When the desired beverage has been selected, press the “” button to start brewing.



Note:

If you press the “” button without choosing any product, the machine returns to the main menu after 10 seconds.

The special beverages function allows you to only brew one beverage at a time. To brew more beverages, repeat the steps from 1 to 3.

Hot Milk



Warning:

Danger of burning! Dispensing may be preceded by jets of milk and steam.

Never seize the carafe handle during the cleaning cycle: danger of burning! Wait until the end of the cycle before removing the milk carafe.

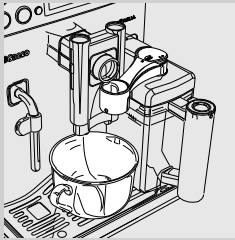

- 1 Insert the milk carafe and place a cup under the dispensing spout. Open the milk dispensing spout by turning it clockwise.



- 2 Press the "☕" button to access the SPECIAL BEVERAGES menu.



- 3 After selecting "MILK FROTH" by pressing the "∨" or "∧" scrolling button, confirm by pressing "✓".

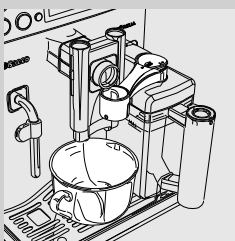

- 4 The machine starts dispensing hot milk. Dispensing can be stopped earlier by pressing the "☕" button.

Hot Water Dispensing



Warning:

Danger of burning! Dispensing may be preceded by small jets of hot water and steam. Do not touch the steam/hot water wand with bare hands.

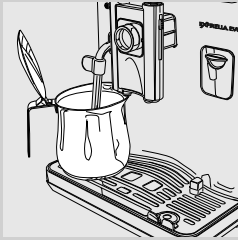

- 1 Place a container under the steam/hot water wand.



- 2 Press the “☕” button to access the SPECIAL BEVERAGES menu.



- 3 After selecting HOT WATER by pressing the “∨” or “∧” scrolling button, confirm by pressing “√”.

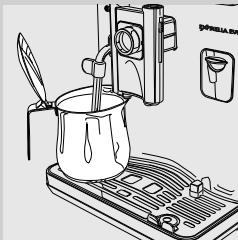

- 4 Hot water is dispensed. Dispensing can be stopped earlier by pressing the “↶” button.

- 5 At the end, remove the container with the desired quantity of water.

Residue water inside the circuit may drip. This is a normal feature of the machine.

Brewing a Strong Coffee

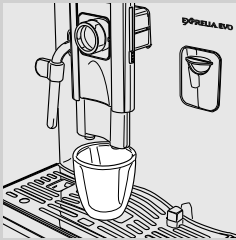

1 Place a cup under the coffee dispensing spout.



2 Press the “☺” button to access the SPECIAL BEVERAGES menu.



3 After selecting RISTRETTO by pressing the “∨” or “∧” scrolling button, confirm by pressing “√”.

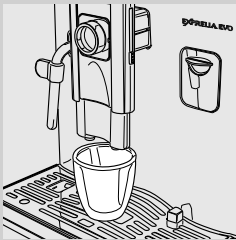

4 Coffee brewing starts.

5 Wait until brewing has been completed, then remove the cup.

Espresso Macchiato



Warning:

Danger of burning! Dispensing may be preceded by jets of milk and steam.

Never seize the carafe handle during the cleaning cycle: danger of burning! Wait until the end of the cycle before removing the milk carafe.

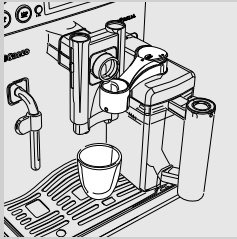

- 1 Insert the milk carafe and place a cup under the coffee dispensing spout. Open the milk dispensing spout by turning it clockwise.



- 2 Press the “☕” button to access the SPECIAL BEVERAGES menu.



- 3 After selecting “ESPRESSO MACCHIATO” by pressing the “∨” or “∧” scrolling button, confirm by pressing “✓”.

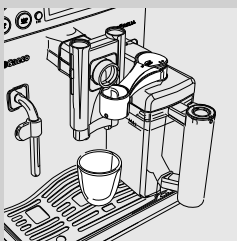

- 4 The machine starts dispensing hot milk. Dispensing can be stopped earlier by pressing the “☞” button.

Flat White



Warning:

Danger of burning! Dispensing may be preceded by jets of milk and steam.

Never seize the carafe handle during the cleaning cycle: danger of burning! Wait until the end of the cycle before removing the milk carafe.

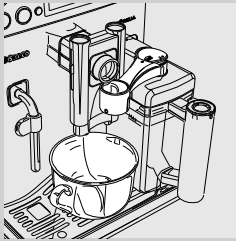

- 1 Insert the milk carafe and place a cup under the dispensing spout. Open the milk dispensing spout by turning it clockwise.



- 2 Press the "☙" button to access the SPECIAL BEVERAGES menu.



- 3 After selecting "FLAT WHITE" by pressing the "∨" or "∧" scrolling button, confirm by pressing "✓".

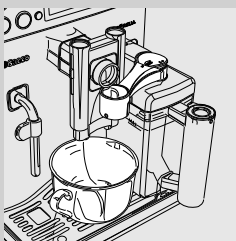

- 4 The machine starts dispensing hot milk. Dispensing can be stopped earlier by pressing the "↶" button.

BEVERAGE PROGRAMMING

The machine can be programmed to tailor the coffee taste to your personal preferences. Each beverage has its own adjustable settings.



- 1 Press the “☰” button to access the machine main menu.

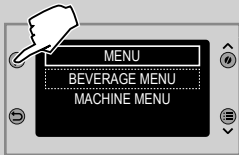

- 2 Press the “✓” button to access the BEVERAGE MENU.



Note:

By pressing the “∨” or “∧” scrolling button and confirming with “✓”, you can choose the desired option.

Cappuccino Programming

The following procedure describes how to program a cappuccino.

The settings of each submenu are explained below. You can select these by pressing the "▼" or "▲" scrolling button. Confirm the settings with "✓".



Press "✓" to select CAPPUCCINO from the beverage menu.

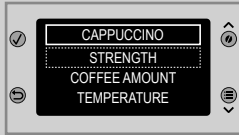

STRENGTH

This setting allows you to adjust the amount of coffee to be ground for beverage brewing.

GROUND = the beverage is brewed using pre-ground coffee

VERY MILD = very mild dose

MILD = mild dose

REGULAR = regular dose

STRONG = strong dose

VERY STRONG = very strong dose

This setting enables the prebrewing function.

COFFEE AMOUNT

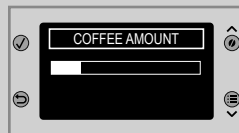

By adjusting the bar on the display with the "▼" or "▲" scrolling button, you can choose the amount of water used for coffee brewing. Press "OK" to confirm the change.

TEMPERATURE

This setting allows you to adjust the coffee temperature.

HIGH: high temperature.

NORMAL: medium temperature.

LOW: low temperature.

TASTE

During prebrewing, the coffee is slightly dampened to bring out the aroma in full.

DELICATE: the prebrewing function is not performed.

BALANCED: the prebrewing function is enabled.

FULL BODY: the prebrewing function takes more time to enhance the coffee taste.

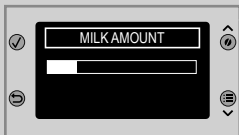
MILK AMOUNT

By adjusting the bar on the display with the “**∨**” or “**∧**” scrolling button, you can choose the amount of milk to be used for the selected beverage. Press “**✓**” to confirm the change.

Note:

The milk managing options are displayed only for the milk-based beverages.

RESTORE TO DEFAULT

For each beverage it is possible to reset the original factory settings. Upon selection of this function, the customized settings are deleted.

To exit programming, press the “**↶**” button at least once until the main menu is displayed.

Hot Water Programming

The following procedure describes how to program hot water.



- 1 Select SPECIAL BEVERAGES from the beverage menu by pressing the "▼" or "▲" scrolling button. Press "✓" to confirm.



- 2 Select HOT WATER by pressing the "▼" or "▲" scrolling button. Press "✓" to confirm the change.



By adjusting the bar on the display with the "▼" or "▲" scrolling button, you can choose the amount of hot water to be dispensed. Press "✓" to confirm.

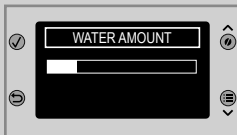

This setting allows you to adjust the water dispensing temperature.

- HIGH:** high temperature.
- NORMAL:** medium temperature.
- LOW:** low temperature.



Reset the original factory settings. Upon selection of this function, the customized settings are deleted.

MACHINE PROGRAMMING



1 Press the “☰” button to access the machine main menu.

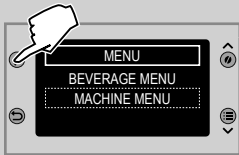

2 Select MACHINE MENU by pressing the “∨” or “∧” scrolling button. Press “✓” button to confirm.

AQUACLEAN FILTER

AquaClean Filter

The general menu allows you to adjust the water parameters in order to brew the best possible coffee.

Settings Menu

SETTINGS	The general menu allows you to change the operation settings.
LANGUAGE	This setting is important to automatically adjust the machine parameters according to the user's country.
BRIGHTNESS	This setting allows you to adjust the display brightness.
BUTTON SOUND	The BUTTON SOUND function activates/deactivates the sound feedback.
ECOMODE	The ECOMODE function allows you to save energy by keeping the boiler activation level at one when starting up the machine. If you wish to dispense more milk-based beverages, warm-up time may increase. The function is set by default to ON.
STAND-BY TIME	The STAND-BY TIME function sets the time lapse for the machine to go into stand-by mode after the last brewing. The stand-by time ranges from 15, 30, 60 and 180 minutes. The default time value is 15 minutes.
WATER HARDNESS	Under WATER HARDNESS you can set the water hardness level. For water hardness measuring, refer to the "Measuring and Programming Water Hardness" chapter.
RESTORE TO DEFAULT	Activating the RESTORE TO DEFAULT option will restore all machine settings to their default values. In this case, all customized parameters will be deleted.

Maintenance Menu

- 

MAINTENANCE The MAINTENANCE menu allows you to set all the functions for correctly managing machine maintenance.
- BREW GROUP CLEAN** The BREW GROUP CLEAN function enables the brew group monthly cleaning (see the “Monthly Cleaning of the Brew Group with Coffee Oil Remover” chapter).
- CARAFE CLEANING** The CARAFE CLEANING function enables the milk carafe monthly cleaning (see the “Monthly Cleaning of the Milk Carafe” chapter).
- DESCALING** The DESCALING function activates the descaling cycle (see the “Descaling” chapter).
- CARAFE CLEAN** The CARAFE CLEAN function allows you to run the milk carafe automatic self-cleaning cycle. The function is set by default to ON.

Statistics Menu

- 

STATISTICS The STATISTICS menu shows how many products have been brewed for every single type of coffee since the last reset.
- RESET STATISTICS** The RESET STATISTICS function allows you to reset all counts carried out until that moment.

CLEANING AND MAINTENANCE

Daily Cleaning of the Machine



Caution:

Timely cleaning and maintenance of your machine is very important as it prolongs the life of your machine. Your machine is continuously exposed to moisture, coffee and limescale!

This chapter describes in detail which activities you need to perform and how often you need to perform them. Not doing this will ultimately make your machine stop working properly. This repair is NOT covered by warranty!



Note:

- Use a soft, dampened cloth to clean the machine.
- Do not wash any removable part in the dishwasher.
- Do not use alcohol, solvents and/or abrasive objects to clean the machine.
- Do not immerse the machine in water.
- Do not dry the machine and/or its components using a microwave and/or standard oven.

Empty and clean the coffee grounds drawer and the (internal) drip tray every day with the machine turned on. Please follow the steps below:

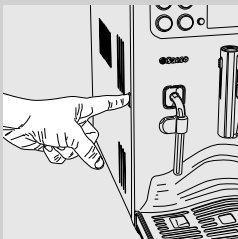

- 1** Press the button and open the service door.

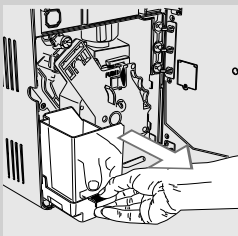

- 2** Remove the (internal) drip tray and coffee grounds drawer.

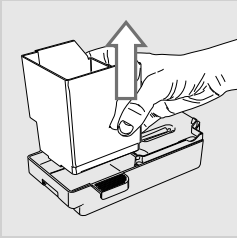

3 Empty the coffee grounds drawer and wash it with fresh water.

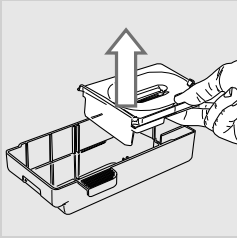

4 Empty the (internal) drip tray and the lid and wash them with fresh water.

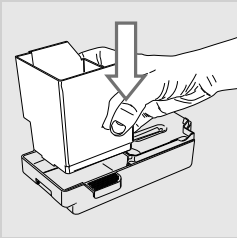

5 Correctly reinstall all the components.

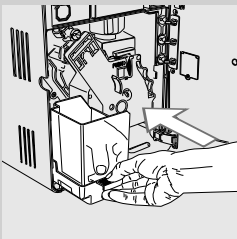

6 Insert the drip tray and the coffee grounds drawer and close the service door.



Note:

If the coffee grounds drawer is emptied when the machine is off, the coffee grounds counter is not reset. In this case, the machine might display the "EMPTY COFFEE GROUNDS DRAWER" message too soon.

Daily Cleaning of the Water Tank

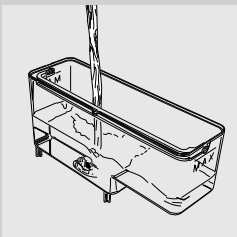

1 Remove the small white filter or the AquaClean filter (if installed) from the water tank and wash it with fresh water.

2 Put the small white filter or the AquaClean filter (if installed) back in its housing by gently pressing and turning it at the same time.

3 Fill the water tank with fresh water.

Daily Cleaning of the Milk Carafe: "CLEAN" Self-cleaning Cycle (After Each Use)

After preparing a milk-based beverage, the machine performs an automatic cleaning cycle by releasing steam jets from the milk dispensing spout.

You can also activate this cycle manually by pressing the "☺" button on the control panel. You can perform this operation at any time.

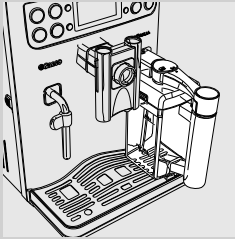

- 1 Insert the milk carafe into the machine as described in the "Milk Carafe" chapter. Close the milk dispensing spout.



- 2 Press the "☺" button to start the cleaning cycle.

Weekly Cleaning of the Machine

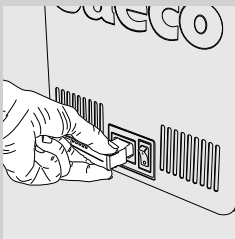

- 1 Turn off the machine and unplug it.

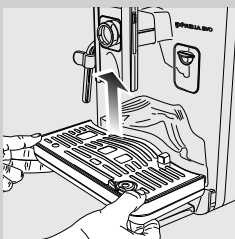

- 2 Remove the (external) drip tray.

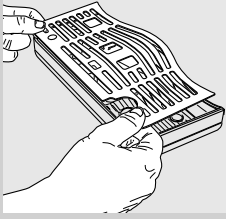

3 Remove the grill and wash it thoroughly.

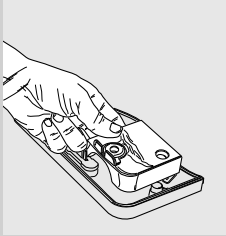

4 Remove the support under the grill. Wash the support and the drip tray.



5 Dry the grill, reassemble it and place it back in the machine.

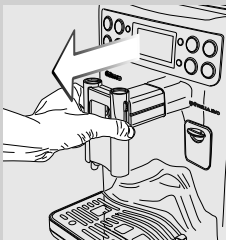

6 Remove the dispensing spout and wash it with water.

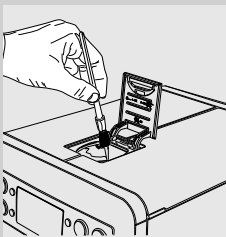

7 Clean the pre-ground coffee compartment with a brush or a dry cloth.

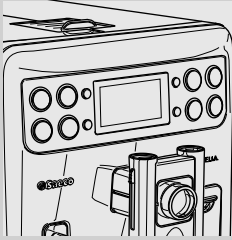

- 8 Clean the steam/hot water wand and the display with a damp cloth.

Weekly Cleaning of the Milk Carafe

The weekly cleaning is more thorough as any milk residue is removed from the carafe dispensing spout.

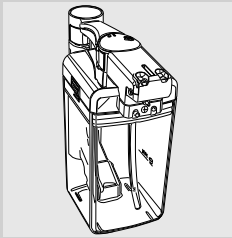

- 1 Before cleaning, remove the carafe from the machine and empty it.



- 2 Open the milk dispensing spout by turning it clockwise.

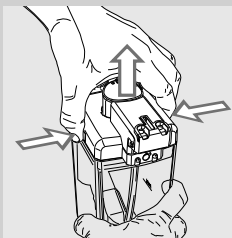

- 3 Press on the sides and lift the lid.

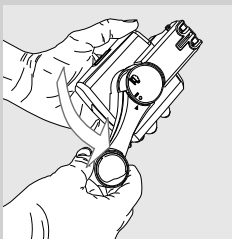

- 4 Rotate the handle counter-clockwise to the unlock position up to the "●" icon.

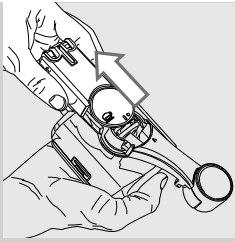

5 Remove the connector which comes into contact with the machine.

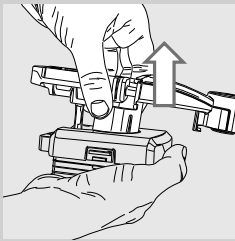

6 Remove the handle with the suction tube.

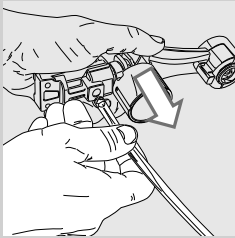

7 Remove the suction tube.

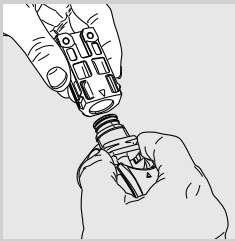

8 Remove the external fitting.



9 Remove the internal fitting.

10 Clean all the parts thoroughly with lukewarm water.

11 Reassemble the parts following the same procedure, but in reverse order.



Caution:
Do NOT wash the carafe components in the dishwasher.

Weekly Cleaning of the Brew Group

The brew group should be cleaned every time the coffee bean hopper is filled or at least once a week.

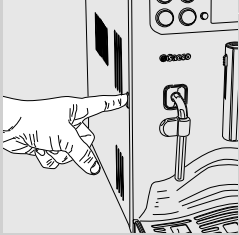

- 1 Press the button and open the service door.

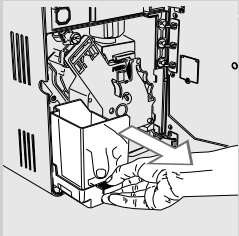

- 2 Remove the (internal) drip tray and coffee grounds drawer.

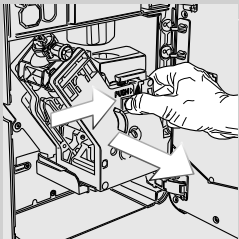

- 3 To remove the brew group, press the «PUSH» button and pull it by the handle.

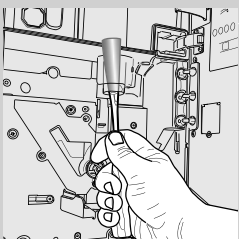

- 4 Clean the coffee outlet duct thoroughly with a spoon handle or with another round-tipped kitchen utensil.

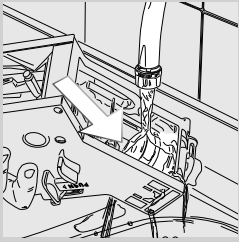

5 Thoroughly wash the brew group with fresh, lukewarm water and carefully clean the upper filter.

! **Caution:**

Do not use any detergent or soap to clean the brew group.

6 Let the brew group air-dry thoroughly.

7 Thoroughly clean the inside of the machine using a soft, dampened cloth.

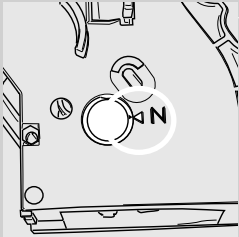

8 Make sure that the brew group is in the off position; the two reference marks must match. If they do not match, proceed as described in step (9).

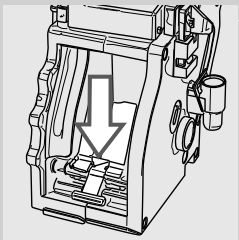

9 Gently pull down the lever until it is in contact with the brew group base and the two reference marks on the side of the brew group match.

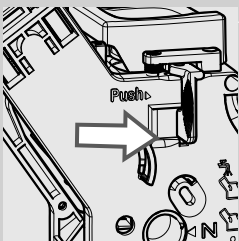

10 Press the "PUSH" button firmly.

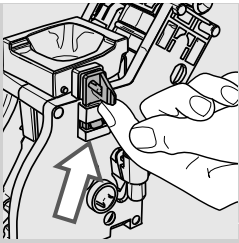

- 11** Make sure that the hook which locks the brew group is in the correct position. If it is still in the downward position, push it upward until it locks correctly into place.

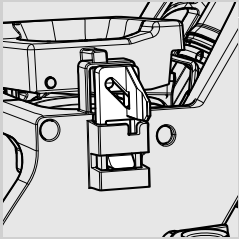

- 12** Insert the brew group back into its seat until it locks into place without pressing the "PUSH" button.

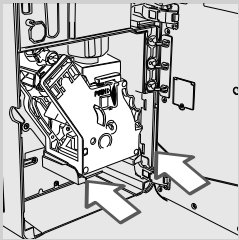

- 13** Insert the (internal) drip tray and the coffee grounds drawer and close the service door.

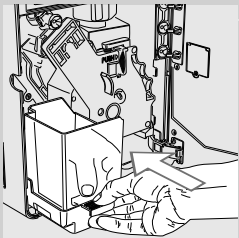

Monthly Cleaning of the Milk Carafe

In the monthly cleaning cycle we recommend using the "Saeco Milk Circuit Cleaner" to keep the entire circuit clean of milk residues. The "Saeco Milk Circuit Cleaner" can be purchased separately. For further details, please refer to the maintenance products page.



- 1 Select the MAINTENANCE option from the machine menu.
- 2 Select CARAFE CLEANING. Press the "✓" button to confirm.

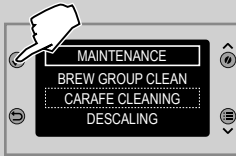

- 3 Press the "✓" button to confirm.

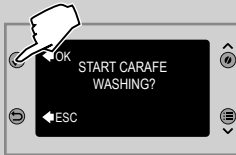

- 4 Fill the water tank with fresh water up to the MAX level. Press the "✓" button.

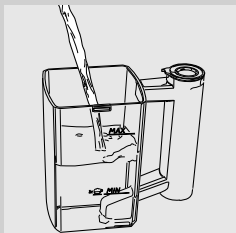
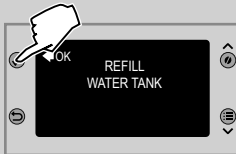

- 5 Fill the milk carafe with fresh drinking water up to the MAX level. Pour one milk cleaner bag into the milk carafe and let it dissolve completely.

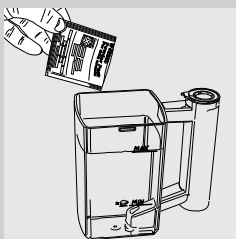

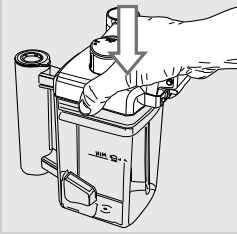

6 Put the lid back on.

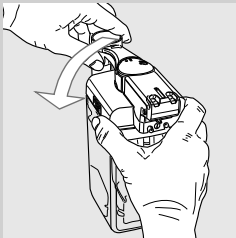

7 Rotate the milk dispensing spout counter-clockwise to the lock position.

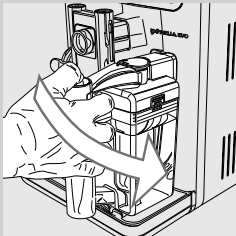

8 Insert the milk carafe into the machine.

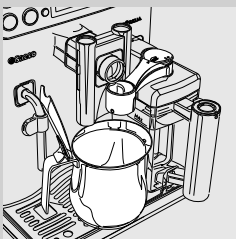
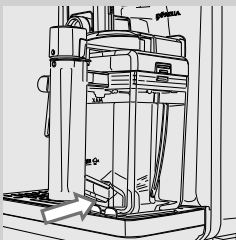

9 Place a large container (1.5 l) under the dispensing spout. Open the milk dispensing spout by turning it clockwise.

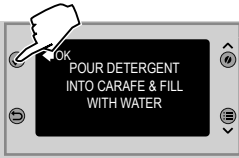

10 Press the "✓" button to start the cycle. The machine starts dispensing the solution through the milk dispensing spout.



11 This icon is displayed. The bar shows the cycle progress.

 **Warning:**
Never drink the solution dispensed during this step.

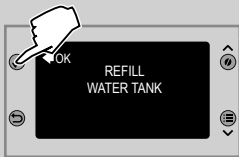

12 When the machine stops dispensing, fill the tank with fresh water up to the MAX level. Press the "✓" button to confirm.



13 Remove the milk carafe and the container from the machine.



14 Wash the milk carafe thoroughly and fill it with fresh water. Insert the milk carafe into the machine. Press the "✓" button to confirm.

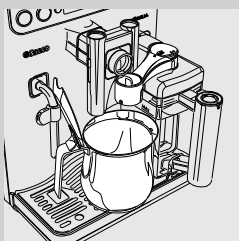

15 Empty the container and place it back under the coffee dispensing spout. Open the milk dispensing spout by turning it clockwise.



16 The machine starts dispensing water from both the coffee dispensing spout and the milk dispensing spout. The bar shows the cycle progress.

17 At the end of the cycle, the machine returns to the product brewing menu.

18 Disassemble and wash the milk carafe as described in the “Weekly Cleaning of the Milk Carafe” chapter.

Monthly Lubrication of the Brew Group



Lubricate the brew group after approximately 500 cups of coffee or once a month.

You can purchase the Saeco grease to lubricate the brew group separately. For further details, please refer to the maintenance products page in this user manual.



Caution:

Before lubricating the brew group, clean it with fresh water and dry it as described in the “Weekly Cleaning of the Brew Group” chapter.

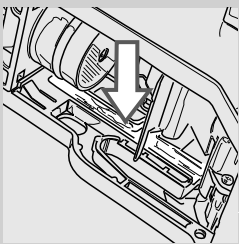

1 Apply the lubricant evenly on both side guides.

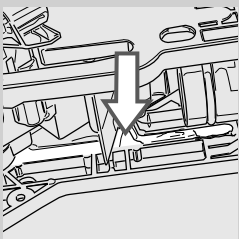

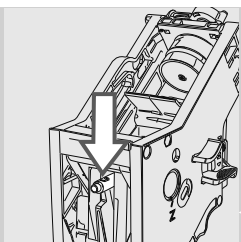

2 Also lubricate the shaft.

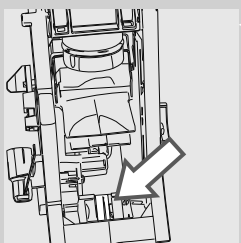

3 Insert the brew group into its seat until it locks into place (see the “Weekly Cleaning of the Brew Group” chapter).

4 Insert the (internal) drip tray and the coffee grounds drawer and close the service door.

Monthly Cleaning of the Brew Group with “Coffee Oil Remover”



Besides weekly cleaning, we recommend performing a cleaning cycle with “Coffee Oil Remover” after approximately 500 cups of coffee or once a month. This operation completes the maintenance process for the brew group.

You can purchase the “Coffee Oil Remover” and the “Maintenance Kit” separately. For further details, please refer to the maintenance products page.



Caution:

The “Coffee Oil Remover” tablets are to be used for cleaning only and do not have a descaling function. For descaling, use the Saeco descaling solution and follow the procedure described in the “Descaling” chapter.

1 Select the “MAINTENANCE” option from the machine menu.

2 Select “BREW GROUP CLEAN”. Press the “✓” button.

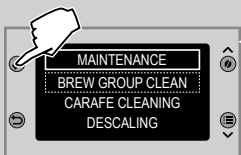

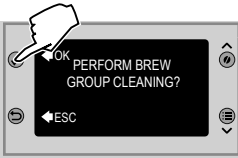

3 Press the "✓" button to confirm.

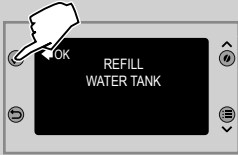

4 Fill the water tank with fresh water up to the MAX level. Press the "✓" button.

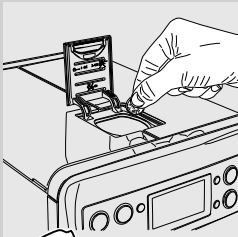

5 Put a "Coffee Oil Remover" tablet in the pre-ground coffee compartment. Press the "✓" button.

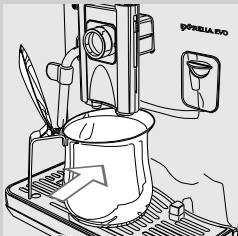

6 Place a container (1.5 l) under the coffee dispensing spout. Press the "✓" button to start the cleaning cycle.

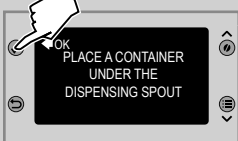



7 This icon is displayed. The bar shows the cycle progress.



Warning:

Never drink the solution dispensed during this step.

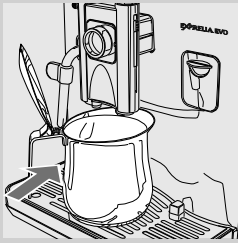

8 When the machine stops dispensing, remove and empty the container.

9 Clean the brew group as described in the "Weekly Cleaning of the Brew Group" chapter.

Monthly Cleaning of the Coffee Bean Hopper

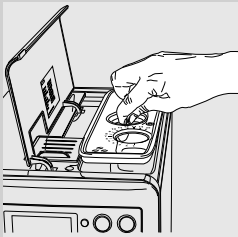

Clean the coffee bean hopper once a month when it is empty with a damp cloth to remove coffee oil. Then refill it with coffee beans.

DESCALING

When the "CALC CLEAN" icon is displayed, you need to descale the machine.

The descaling cycle takes approx. 30 minutes.



Caution:

Not doing this will ultimately make your machine stop working properly. In this case, repair is NOT covered by warranty.



Warning:

Use the Saeco descaling solution only. Its formula has been designed to ensure better machine performance. The use of other products may damage the machine and leave residues in the water.

The Saeco descaling solution can be purchased separately. For further details, please refer to the maintenance products page in this user manual.



Warning:

Never drink the descaling solution or any products dispensed until the cycle has been carried out to the end. Never use vinegar as a descaling solution.



Note:

Do not remove the brew group during the descaling process.

To perform the descaling cycle, follow the steps below.

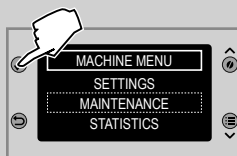

- 1 Select the "MAINTENANCE" option from "MACHINE MENU" and confirm by pressing "✓".

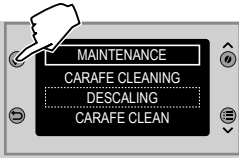

2 Select "DESCALING" and confirm with "✓".

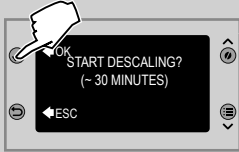

3 Press the "✓" button to confirm.



Note:

If you press the "✓" button by mistake, press the "↶" button to quit.

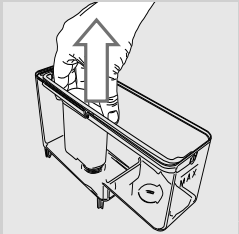

4 Remove the water tank and the AQUACLEAN water filter (if any).

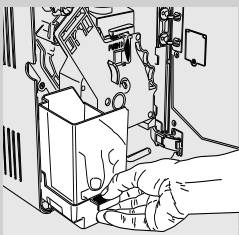

5 Empty the drip tray (internal) / (external).
Press the "✓" button.



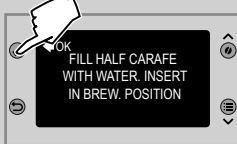
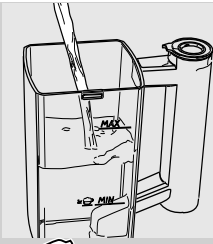

- 6** Fill half the milk carafe with fresh water. Insert the carafe and open the milk dispensing spout by turning it clockwise. Press the "✓" button.



- 7** Place a large container (1.5 l) under both the steam/hot water dispensing spout and the milk carafe dispensing spout. Press the "✓" button.

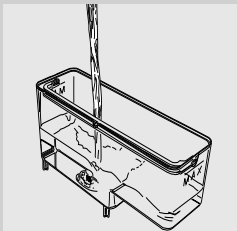

- 8** Pour in the entire content of the Saeco descaling solution. Fill the water tank with fresh water up to the MAX level. Press the "✓" button.

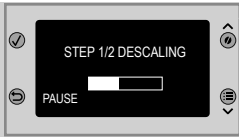

9 The machine will start dispensing the descaling solution at regular intervals. The bar on the display shows the cycle progress.

 **Note:**

To empty the container during the process and to pause the descaling cycle, press the "↶" button. To resume the cycle, press the "✓" button.



10 The message indicates the end of the first step. The water tank needs to be rinsed. Fill the water tank with fresh water up to the MAX level. Press the "✓" button.



11 Empty the (internal) drip tray and place it back, then press the "✓" button.



12 Empty the milk carafe and fill it with fresh water. Put it back into the machine. Press the "✓" button.



- 13** Empty the container and place it under both the steam/hot water dispensing spout and the milk carafe dispensing spout. Press the “✓” button.

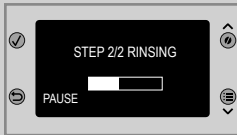

- 14** The rinse cycle starts. The bar shows the cycle progress.



- 15** When the amount of water needed for the rinse cycle has been completely dispensed, the machine automatically ends the descaling process by showing this screen after a short warm-up phase.

- 16** Remove and empty the container.

- 17** Disassemble and wash the milk carafe as described in the “Weekly Cleaning of the Milk Carafe” chapter.

- 18** Empty the (internal) drip tray and place it back.

- 19** Place the AQUACLEAN water filter (if any) back into the water tank.

- 20** The descaling cycle has been completed.



Note:

At the end of the descaling cycle, wash the brew group as described in the “Weekly Cleaning of the Brew Group” chapter.

The rinse cycle is performed in order to have the circuit cleaned with a preset amount of water to ensure proper machine performance. If the water tank is not filled up to MAX level, the machine could require two or more cycles.

Interruption of the Descaling Cycle

Once the descaling cycle has started, it must be completed; do not turn off the machine mid-cycle.



If the machine stops, you can quit the cycle by pressing the ON/OFF button.







If this occurs, or in the event of power failure or accidental disconnection of the power cord, empty and rinse carefully the water tank, then fill it up to the MAX level.

Follow the instructions provided in the "Manual Rinse Cycle" chapter before brewing any beverage.

If the cycle was not completed, the machine will require another descaling cycle to be performed as soon as possible.

MEANING OF THE DISPLAY

Displayed message	How to reset the message
CLOSE HOPPER DOOR	Close the coffee bean hopper inner lid.
ADD COFFEE	Fill the coffee bean hopper.
INSERT BREW GROUP	The brew group must be inserted into the machine.
INSERT COFFEE GROUNDS DRAWER	Insert the coffee grounds drawer and the internal drip tray.
EMPTY COFFEE GROUNDS DRAWER	Empty the coffee grounds drawer.  Note: The coffee grounds drawer must be emptied only when the machine requires it and with the machine on. If the drawer is emptied with the machine turned off, the machine will not record the emptying operation.
CLOSE FRONT DOOR	Close the service door.
REFILL WATER TANK	Remove the water tank and fill it.
EMPTY DRIP TRAY	Open the service door and empty the internal drip tray.  Warning: If this operation is performed when the machine is on, it will record the coffee grounds drawer emptying and will reset the counter; therefore, you need to empty the coffee grounds as well.
TURN CARAFE INTO BREWING POSITION ◀ESC	Open the milk carafe dispensing spout to brew products. Press the "↶" button to exit.
TURN CARAFE INTO RINSING POSITION ◀ESC	Close the milk carafe dispensing spout to start the carafe cleaning cycle. Press the "↶" button to exit.

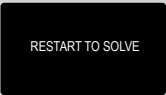
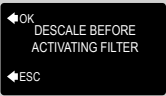
Displayed message	How to reset the message
	<p>Insert the milk carafe to start brewing. Press “” to exit.</p>
	<p>You need to descale the machine. Follow the steps described in the “Descaling” chapter of this manual. <u>Please note that not descaling your machine will ultimately make it stop working properly. In this case, repair is NOT covered under your warranty.</u></p>
	<p>The AQUACLEAN icon flashes and shows (0%). The machine needs the AQUACLEAN water filter to be replaced.</p> <p> Note: If the filter is not replaced promptly, the machine will require a descaling cycle to be performed.</p>
	<p>The red light flashes. Press the “” button to exit the stand-by mode.</p>
	<p>Take note of the code (E xx) displayed in the right bottom corner. Turn off the machine. Turn it back on after 30 seconds. Repeat the procedure 2 or 3 times. If the machine does not start, contact the Philips SAECO hotline in your country and quote the code shown on the display. Contact details can be found in the warranty booklet packed separately or at www.philips.com/support.</p>
	<p>The machine needs to be descaled as the 8-filter series has been used up. After descaling, the machine will restart the count of the 8-filter series from 0/8.</p>

TROUBLESHOOTING

This chapter summarizes the most common problems you could encounter with your machine.

If you are unable to solve the problem with the information below, visit www.saeco.com/support for a list of frequently asked questions or contact the Philips Saeco hotline in your country.

Contact details can be found in the warranty booklet packed separately or at www.saeco.com/support.

Machine actions	Causes	Solutions
The machine does not turn on.	The machine is not connected to the electric network.	Connect the machine to the electric network.
	The power button is set to "0".	Check that the power button is set to "1".
The drip tray gets filled although no water is drained.	Water is sometimes drained automatically by the machine into the drip tray to manage circuit rinsing and ensure optimum machine performance.	This is a normal behaviour of the machine.
Coffee is not hot enough.	The cups/mugs are cold.	Preheat the cups/mugs with hot water or use the hot water dispensing spout.
	The beverage temperature in the programming menu is set on Low.	Make sure that the temperature in the programming menu is set on Normal or High.
	You added cold milk to the coffee.	Cold milk lowers the temperature of the final product. Preheat milk before adding it to the beverage.
No hot water is dispensed.	The steam/hot water dispensing spout is clogged or dirty.	Clean the steam/hot water dispensing spout (see the "Cleaning and Maintenance" chapter). Inspect the spout to check that the dispensing spout is not clogged. Make a hole in the limescale using a pin or a needle.
The machine does not fill the cup/mug.	The machine has not been programmed.	Access the beverage programming menu and adjust the coffee length setting according to your personal taste for each type of beverage.
Coffee does not have enough crema (see note).	The blend is unsuitable, coffee is not freshly roasted or the grind is too coarse.	Change coffee blend or adjust grinding as explained in the "Adjusting the Ceramic Coffee Grinder" chapter.
	The coffee beans or the pre-ground coffee are too old.	Make sure that you use fresh coffee beans or pre-ground coffee.
Milk does not froth.	The carafe is dirty or not inserted correctly.	Ensure that the carafe is clean and has been correctly inserted.

Machine actions	Causes	Solutions
The machine takes a long time to warm up or the amount of water dispensed from the wand is too little.	The machine circuit is clogged by limescale.	Descale the machine.
The brew group cannot be removed.	The brew group is out of place.	Turn on the machine. Close the service door. The brew group automatically returns to the initial position.
	The coffee grounds drawer is inserted.	Remove the coffee grounds drawer before removing the brew group.
The brew group cannot be inserted.	The brew group is not in the off position.	Make sure that the brew group is in the off position. The arrows must face each other. To this purpose, see the "Monthly Lubrication of the Brew Group" chapter.
	The gear is not in the initial position.	Insert the drip tray and the coffee grounds drawer and close the service door. Turn on the machine. The gear automatically returns to the initial position. You can now insert the brew group.
There is a lot of ground coffee under or over the brew group.	The coffee used may not be suitable for automatic machines.	You may need to change the type of coffee or the coffee grinder settings (see the "Adjusting the Ceramic Coffee Grinder" chapter).
	The machine is adjusting the coffee grinder for a new kind of coffee beans or pre-ground coffee.	The machine automatically adjusts itself after brewing several cups of coffee in order to optimise extraction in relation to the compactness of ground coffee. It may be necessary to brew 2 or 3 products to completely adjust the coffee grinder. This is not a machine malfunction.
The machine produces too humid or too dry coffee grounds.	Adjust the coffee grinder.	Adjusting the ceramic coffee grinder affects the quality of residues. If the residues are too humid, set a coarser grind. If the residues are too dry, set a finer grind. Refer to the "Adjusting the Ceramic Coffee Grinder" chapter.

Machine actions	Causes	Solutions
The machine grinds the coffee beans but no coffee is brewed (see note).	There is no water.	Fill the water tank and prime the circuit (see the "Manual Rinse Cycle" chapter).
	The brew group is dirty.	Clean the brew group (see the "Weekly Cleaning of the Brew Group" chapter).
	This might occur when the machine is automatically adjusting the dose.	Brew some cups of coffee as described in the "Saeco Adapting System" chapter.
	The dispensing spout is dirty.	Clean the dispensing spout.
The coffee is too weak (see note).	This might occur when the machine is automatically adjusting the dose.	Brew some cups of coffee as described in the "Saeco Adapting System" chapter.
	The ground coffee is too coarse.	Change coffee blend or adjust grinding as explained in the "Adjusting the Ceramic Coffee Grinder" chapter.
Coffee is brewed slowly (see note).	The coffee grind is too fine.	Change coffee blend or adjust grinding as explained in the "Adjusting the Ceramic Coffee Grinder" chapter.
	The circuits are clogged.	Perform a descaling cycle.
	The brew group is dirty.	Clean the brew group (see the "Weekly Cleaning of the Brew Group" chapter).
Coffee leaks out of the dispensing spout.	The dispensing spout is clogged.	Clean the dispensing spout and its holes.

**Note:**

These problems can be considered normal if the coffee blend has been changed or if the machine has just been installed. In this case, wait until the machine performs a self-adjusting operation as described in the "Saeco Adapting System" chapter.

ENERGY SAVING

Stand-by

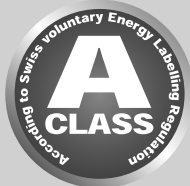

The Saeco fully automatic espresso coffee machine is designed for energy saving, as proven by the Class A energy label.

After a certain time of inactivity that can be set by the user (see the “Machine Programming” chapter), the machine turns off automatically. If a product has been brewed, the machine performs a rinse cycle. In stand-by mode, the energy consumption is below 1Wh.

To turn on the machine, press the “” button (if the power button on the back of the machine is set to “I”). If the boiler is cold, the machine performs a rinse cycle.

The machine status can be manually changed to stand-by mode by keeping the STAND-BY button pressed for 3 seconds.



Note:

- 1 The machine will not go into stand-by mode if the service door is open.
- 2 When the stand-by mode is activated, the machine may perform a rinse cycle. The cycle can be interrupted by pressing the “STOP” button.

The machine can be reactivated by:

- 1 Pressing any button on the control panel.
- 2 Opening the service door (when closing the door, the machine goes back to stand-by mode).

The red indicator light on the “” button flashes when the machine is in stand-by mode.

Screen Saver

The machine comes with a screen saver extending the life of the display. After 5 minutes of inactivity, the machine logo will start floating. When this occurs, the machine is active and pressing any button will immediately activate all functions.



Note:

The screen saver will not be activated if there is an ongoing warning signal.

TECHNICAL SPECIFICATIONS

The manufacturer reserves the right to make changes to the technical specifications of the product.

Nominal Voltage - Power Rating - Power Supply	See data plate on the appliance
Housing material	Thermoplastic material
Size (w x h x d)	245 x 360 x 420 mm
Weight	13.4 kg
Power cord length	1200 mm
Control panel	Front panel
Cup size	110 mm
Water tank	1.5 litres - Removable type
Coffee bean hopper capacity	300 g
Coffee grounds drawer capacity	11
Pump pressure	15 bar
Boiler	Stainless Steel
Safety devices	Boiler pressure safety valve – Double safety thermostat
Safety devices	Thermostat

WARRANTY AND SERVICE

Warranty

For detailed information on your warranty and related conditions, please read the warranty booklet supplied separately.

Service

We want to ensure that you remain satisfied with your machine. If you have not already done so, please register your purchase at www.saeco.com/welcome. This will enable us to stay in contact with you and send you cleaning and descaling reminders.

For service or support, please visit the Philips website at www.saeco.com/support or contact the Philips Saeco hotline in your country. The contact details can be found in the warranty booklet supplied separately or at www.saeco.com/support.

ORDERING MAINTENANCE PRODUCTS

For cleaning and descaling, use Saeco maintenance products only. You can purchase the products at the Philips online shop at www.shop.philips.com/service, from your local dealer or at authorised service centres.

If you have any difficulties obtaining maintenance products for your machine, please contact the Philips Saeco hotline in your country.

Contact details can be found in the warranty booklet packed separately or at www.saeco.com/support.

Overview of maintenance products



- Descaling solution CA6700



- AquaClean filter CA6903



- Grease HD5061



- Coffee Oil Remover CA6704



- Milk Circuit Cleaner CA6705

02

Rev.00 del 15-09-15



421946032791

EN

02

The manufacturer reserves the right to make changes without prior notice.



www.philips.com/saeco