

Operating Instructions

Counter Top Coffee System



To prevent accidents and machine damage, read these instructions **before** installation or use.

Contents

IMPORTANT SAFETY INSTRUCTIONS	5
Guide to the machine	10
Controls and display	11
Accessories	12
First use	13
Before using for the first time	13
Turning on for the first time	13
Water hardness	14
Operation	15
Filling the water container	16
Filling the coffee bean container	17
Turning the machine On / Off	18
Cup heating	19
Adjusting the coffee dispensers to the cup height	20
How to prepare beverages	21
Coffee specialties	21
Double portion	22
Canceling preparation	22
Making coffee with ground coffee	23
Adding ground coffee	23
Making coffee with ready ground coffee	24
Drinks with milk	24
Preparing hot water	27
Preparing User profile drinks	27
Coffee the way you like it	28
Grinder setting	28
Displaying and changing the parameters of a drink	29
Amount of coffee	29
Brewing temperature	30
Pre-brewing	30
Portion size	31
Changing the portion size during drink preparation	31
Changing portion sizes in the "Parameters" menu \emptyset	33
Changing the portion size for different User profiles	33

Profiles	34
Accessing a profile	34
Creating a profile	34
Selecting a User profile	35
Changing the name	35
Deleting a profile	35
Changing a profile	36
Settings	37
Accessing the "Settings" menu	37
Changing and saving settings	37
Setting options	38
Language	39
Time of day	39
Timer	39
Eco mode	40
Lighting	40
Info (displaying information)	41
Locking the coffee system (System lock )	41
Water hardness	41
Display brightness	41
Volume	41
Cup heating	41
Factory default	42
Showroom program (demo mode)	42
Cleaning and care	43
Quick guide	43
Rinsing the coffee system	44
Milk pipework	45
Main dispenser with cappuccinatore	47
Milk container	48
Water container	49
Drip tray cover	49
Drip tray and waste container	50
Bean container and ground coffee chute	51
Brew unit	51
Remove the brew unit and wash by hand	51
Degreasing the brew unit	53
Housing	54

Contents

Descaling the machine	55
Frequently Asked Questions	58
Transport	69
Evaporating the coffee system	69
Packing	69
Technical service and warranty	70
Saving energy	71
Installation instructions	73
Packaging material / Disposal of old machine	74
Electrical connection	75
Installation	76
Appliance dimensions	77
Technical details	79
Contact details	83

IMPORTANT SAFETY INSTRUCTIONS

When using electrical appliances basic safety precautions should always be followed, including the following:

Read all instructions before installation or use of the coffee system.

Please read these instructions carefully to prevent accidents and machine damage.

This appliance complies with current safety requirements. Improper use of the appliance can cause personal injury and material damage. Read this safety information carefully before operating the appliance. They contain important information on the safe installation, operation, and care of your coffee system. To avoid the risk of personal injury or damage to the coffee system, it is important that you carefully read the instructions. Miele cannot be held liable for damage caused by non-compliance with these **IMPORTANT SAFETY INSTRUCTIONS.**

Keep these instructions in a safe place and pass the on to any future user.

Intended use

- ▶ This coffee system is not designed for commercial use. It is intended for household use and only, for the preparation of coffee, cappuccino, espresso, etc. Do not use appliance other than for its intended use. Any other use could be dangerous.
- ▶ The coffee system is not suitable for outdoor use.
- ▶ The machine is intended only for the preparation of coffee-based drinks such as espresso, cappuccino, latte macchiato, hot water, steam, frothed milk, etc. Any other usage is not supported.
- ▶ Persons who are unable to safely operate the appliance due to limited physical, sensory or mental capabilities, or because of a lack of experience or knowledge, may only use the appliance if they are supervised while doing so.

IMPORTANT SAFETY INSTRUCTIONS

Safety with children

 The coffee and dispensers present a danger of burning or scaling.

Children's skin is far more sensitive to high temperatures than that of adults.

Ensure children do not touch hot surfaces of the coffee system or place parts of their body under the dispensers.

- ▶ Keep the coffee system out of reach of children.
- ▶ Keep children away from the machine, the power cord and outlet.
- ▶ Close supervision is necessary when the coffee machine is used near children.
- ▶ Never let children play with the coffee machine.
- ▶ Remember that coffee and espresso are not suitable drinks for children.
- ▶ Danger of suffocation!
Keep children away from any packing material.

Technical safety

- ▶ Before installing the coffee system, check for externally visible damage. If the coffee system is damaged, it may pose a safety hazard and must not be used under any circumstances.
- ▶ Before connecting the coffee system, check the voltage and frequency indicated on the data plate against the voltage and frequency of the household electrical supply. This data must correspond in order to prevent damage to the coffee system. If in doubt, consult a qualified electrician.
- ▶ Be certain your appliance is properly installed. To guarantee the electrical safety of this appliance, continuity must exist between the appliance and an effective grounding system. It is imperative that this basic safety requirement be met. If there is any doubt, have the electrical system of the house checked by a qualified electrician.
- ▶ Do not connect the machine to the electrical supply using an extension cord.
- ▶ Unplug the machine from the power supply immediately if you notice any damage or smell.
- ▶ Do not operate any appliance with a damaged cord or plug or after the appliance malfunctions, or has been damaged in any manner. Return appliance to the nearest authorized service facility for examination, repair or adjustment.

IMPORTANT SAFETY INSTRUCTIONS

- ▶ Ensure that the power cord will not be pinched or damaged by any sharp edges.
- ▶ Do not let cord hang over edge of table or counter, or touch hot surfaces.
- ▶ Do not place on or near a hot gas or electric burner, or in a heated oven.
- ▶ The coffee system may not be used in mobile installations such as ships.
- ▶ Only use the coffee system in rooms where the ambient temperature is between 50 °F / 10 °C and 100 °F / 38 °C.
- ▶ Danger of overheating! Ensure that there is sufficient ventilation around the coffee system. Do not cover it with tea towels etc. while it is in use.
- ▶ If the coffee system is installed behind a cabinet door, it may only be used with the cabinet door open. Do not close the cabinet door while the coffee system is in use.
- ▶ Protect the coffee system from water and water spray.
- ▶ Installation, maintenance and repairs may only be carried out by qualified technicians.
- ▶ Repairs must only be performed by a trained technician in accordance with national and local safety regulations. Repairs and other work by unauthorized persons could be dangerous and may void the warranty.
- ▶ Defective components should be replaced by Miele original parts only. Only with original Miele parts can the manufacturer guarantee the safety of the appliance.
- ▶ To disconnect, turn main switch to "0", then remove plug from wall outlet.
- ▶ Unplug from outlet when not in use and before cleaning. Allow to cool before putting on or taking off parts, and before cleaning the appliance.
- ▶ To protect against fire, electric shock and injury to persons do not immerse cord, plugs, or coffee machine in water or other liquid.
- ▶ Use only genuine original Miele parts. If parts or accessories from other manufacturers are used, the warranty may become void. The use of accessory attachments not recommended by Miele may result in fire, electric shock or injury to persons.

IMPORTANT SAFETY INSTRUCTIONS

Proper use

 Danger of burning and scalding from the spouts. The liquids and steam dispensed are very hot.

▶ Please note:

- Keep away from the area underneath the spouts when hot liquids and steam are being dispensed.
- Do not touch hot surfaces. Use handles or knobs.
- Hot liquid or steam could spatter from the dispensers. Ensure that the main dispenser is clean and fitted correctly.
- Water in the drip tray can also be very hot. Take care when emptying it.
- ▶ Clean the coffee system thoroughly before using for the first time (see "Cleaning and care").
- ▶ To avoid the risk of damage to the machine, please note the following regarding water:
 - Fill the water container with fresh, cold tap water only. Hot or warm water or other liquids could damage the coffee system.
 - Change the water every day to prevent a build-up of bacteria.
 - Do not use mineral water. Mineral water will cause lime scale deposits to build up in your machine and damage it.
 - Do not use water from reverse osmosis units.

▶ Only fill the bean container with roasted espresso or coffee beans. Do not fill the bean container with coffee beans that have been treated or with ground coffee.

▶ Do not use raw coffee beans (green, unroasted coffee beans) or coffee blends that include raw coffee. Raw coffee beans are very hard and contain moisture that will damage the grinder.

▶ Do not use coffee beans that have been treated with caramel, sugar or other substances. Sugar will damage the coffee system.

▶ Only add ground coffee or cleaning tablets to the ground coffee chute. The cleaning tablets are used for degreasing the brew unit.

▶ Do not use flavored ground coffee in the machine. The sugar content on these grounds clogs the brew unit of the machine. The cleaning tablet is not enough to remove the residue.

▶ Only use milk without additives. Additives in milk usually contain sugar and this will stick to the milk pipework.

▶ If using dairy milk make sure that it has been pasteurized.

▶ Do not place flamed alcohol mixtures underneath the main dispenser. The flames could ignite plastic components and cause them to melt.

▶ Do not place any open flame, e.g. a candle, on or near the coffee system. The coffee system could catch fire.

IMPORTANT SAFETY INSTRUCTIONS

▶ Please note the following with regard to cleaning the coffee system:

- Turn the coffee system off at the main switch before cleaning.
- Clean the coffee system and milk container daily (see "Cleaning and care").
- Make sure that the milk pipework is cleaned regularly and thoroughly. Milk contains natural bacteria that will multiply if the pipework is not sufficiently clean. Contamination in the coffee system can be a health hazard.
- Do not use a steam cleaner to clean this machine. Steam could reach electrical components and cause a short circuit.

▶ Descale the coffee system regularly depending on the water hardness level in your area. Descale the machine more frequently in areas with very hard water. Miele cannot be held liable for damage arising from insufficient descaling, the use of incorrect descaling agent or the use of descaling agent that is not of the appropriate concentration.

▶ Degrease the brew unit regularly with Miele cleaning tablets. Depending on the natural oil content of the coffee used, the brew unit can become blocked quite quickly.

▶ Rinsing espresso/coffee grounds down the drain can cause the sink to clog. Instead, dispose of your espresso/coffee grounds appropriately as biodegradable waste (where facilities exist) or by composting.

▶ Do not use the coffee system to clean objects.

**SAVE THESE INSTRUCTIONS
AND REVIEW THEM
PERIODICALLY**



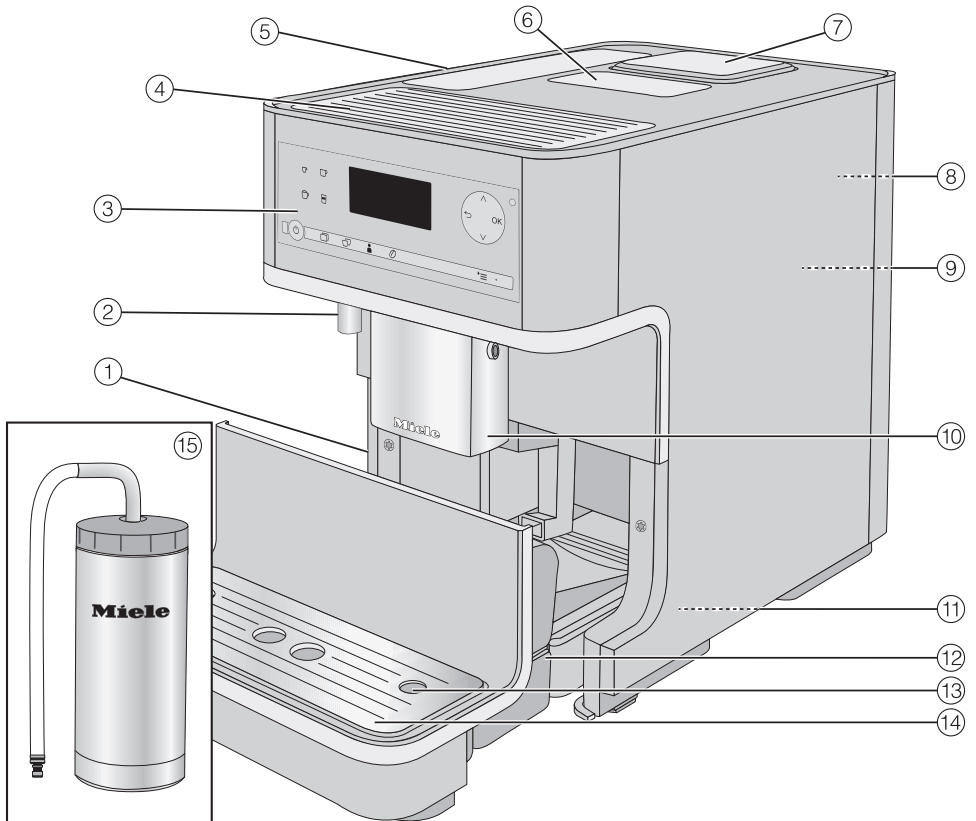





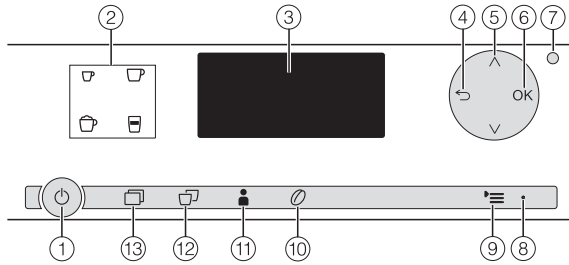



Guide to the machine



- ① Main switch
- ② Hot water spout
- ③ Controls and display
- ④ Cup heating
- ⑤ Water container
- ⑥ Ground coffee chute
- ⑦ Coffee bean container
- ⑧ Grinder setting
(behind the service panel)
- ⑨ Brew unit (behind the service panel)
- ⑩ Main dispenser with cappuccinatore
- ⑪ Park position for milk pipework
(behind the service panel)
- ⑫ Drip tray with lid and waste container
- ⑬ Milk tube aperture
- ⑭ Holder for drip tray cover and drip
tray cover
- ⑮ Stainless steel milk container

Controls and display



① On/Off button 	Turns the coffee system on or off
② Drink buttons	For making  Espresso  Coffee  Cappuccino  Latte macchiato
③ Display	Shows information on current activity or status
④ "Back" 	For returning to the previous menu, canceling unwanted actions
⑤ Arrow keys  	For showing more selection options in the display and highlighting a selection
⑥ OK	For confirming display messages and saving settings
⑦ Optical interface	(for service technician use only)
⑧ LED	Flashes when the machine is turned on and the display is black
⑨ Settings 	For displaying and changing settings
⑩ Parameters 	For changing drink settings
⑪ Profile 	For creating and managing profiles
⑫ Double portion 	For preparing two portions of a drink
⑬ Additional programs 	More drinks such as coffee lungo, caffè latte, hot milk, milk froth and hot water in addition to the other drinks you can find the care program, e. g. degreasing brew unit, rinsing ,...

Accessories

The following accessories are included **depending on the model**:

- **Measuring scoop**
for ground coffee
- **Stainless steel milk container MB-CM**
For keeping milk cool
- **Cleaning tablets**
for degreasing the brew unit (starter set)
- **Descaling tablets**
for descaling the water pipework (starter set)
- **Test strips**
for determining the water hardness level
- **Cleaning brush**
for cleaning the milk pipework

Miele also offers a range of optional accessories, as well as cleaning and conditioning products for your coffee system.

- **Cleaning agent for milk pipework for cleaning the milk system**
- **Cleaning tablets**
for degreasing the brew unit
- **Descaling tablets**
for descaling the water pipework
- **Stainless steel milk container MB-CM**
For keeping milk cool for longer (capacity approx. 16.9 oz. / 0.5 l)

These products and other useful accessories can be ordered via the Miele website.

Please read the operating instructions and take the time to familiarize yourself with the coffee system before using it for the first time.

Please discard the first two cups of coffee/espresso drinks when using the machine for the first time.

Before using for the first time

- Set up the coffee system and remove any protective film (see "Installation").

Clean the machine thoroughly before filling it with water and coffee beans (see "Cleaning and care").

- Plug in the coffee system (see "Electrical connection").

Turning on for the first time

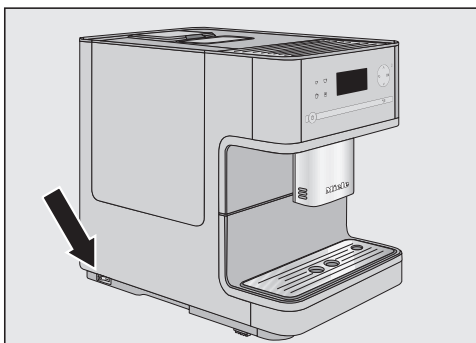

- Set the main switch on the left-hand side of the machine to the "I" position.

When you turn the machine on for the first time, the following message will appear in the display: "Miele - Willkommen".

Language

- Use the arrow keys to highlight the desired language. Then touch OK.
- Use the arrow keys to highlight the desired country. Then touch OK.

The setting is now saved.

Time of day

- Touch the arrow keys until the current hour appears. Then touch OK.
- Touch the arrow keys until the current minutes appear. Then touch OK.

The setting is now saved.

"Set up successfully completed" will now appear in the display.

The message "Fill and replace the water container" appears in the display.

- Fill the water container with cold, fresh tap water.

Tip: To get the most out of your coffee system and to set it up for your specific requirements, please continue to work through these operating instructions.

First use

Water hardness

The water hardness level indicates how much calcium is dissolved in the water. The higher the calcium content, the harder the water, and the harder the water, the more often the coffee system will need to be descaled.

The coffee system measures the amount of water used and steam made. Depending on the level of water hardness set, more or fewer drinks can be dispensed before the appliance needs to be descaled.

Program the coffee system to the water hardness level of your area so that it functions correctly and does not get damaged. At the correct time a prompt will then appear in the display to descale the appliance.

You can program four hardness levels on the machine:

Water hardness	Water hardness level in your area	Setting (water hardness level)
0 - 8.7 gr/gal (0 - 8.4 °dH)	Soft	Soft 1
8.7 - 14.6 gr/gal (8.4 - 14 °dH)	Medium	Medium 2
14.6 - 21.2 gr/gal (14 - 21 °dH)	Hard	Hard 3
> 21.2 gr/gal (> 21 °dH)	Hard	Very hard 4

Determining the water hardness

You can measure the water hardness yourself using the enclosed test strip. Alternatively, your local water authority will be able to tell you the hardness of water in your area.

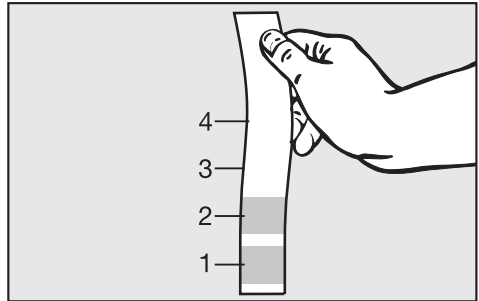

- Dip the strip in your drinking water for approximately one second, then shake off any excess water. The result will be evident after about a minute.

You can now set the water hardness level for the coffee system.

Setting the water hardness level

- Touch ≡ .
- Use the arrow keys to highlight "Water hardness". Then touch OK.
- Use the arrow keys to highlight the desired water hardness. Then touch OK.

The setting is now saved.

To operate the coffee system, touch the keys with your finger.

When the following appears in the display, you are in the drinks menu:

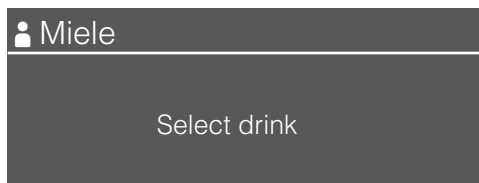

To prepare a coffee drink, touch one of the drink sensors.

You can find more drinks in the "More programs"  menu.

Selecting a menu and navigating within a menu

To select a menu, touch the relevant button. You will then be able to start an action or change settings in the menu.



A scroll bar at the right of the display shows that additional options or text are available. Use the arrow keys to display these.

You will be able to identify the current active setting by the check .

To select an option:

- Touch the ∇ and \blacktriangle arrow keys until the option you want is highlighted.

To confirm your choice:

- Touch OK.

Leaving the menu or canceling an action

To exit the current menu:

- Touch .

If you do not touch a sensor for a period of time, the machine returns to the drinks menu.

Filling the water container

The quality of the water and the quality of the coffee beans play an important part in the quality of the coffee or espresso.

Important! Bacteria can cause infection.

It is important to empty and fill the container with fresh tap water every day to avoid the risk of bacteria building up.

Hot or warm water or other liquids can damage the coffee system.

Do not use mineral water in the water container. It will cause serious lime scale deposits to build up in your machine and damage it.

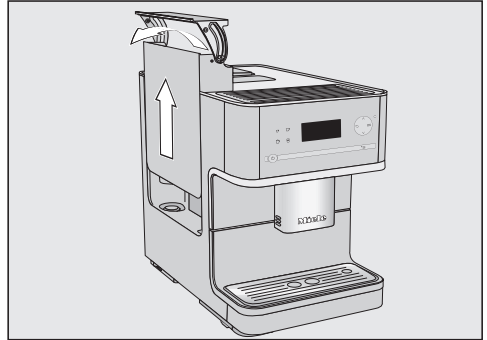

- Press the lid on the right-hand side.
- Pull the water container up by the lid to remove it.
- Fill the water container with fresh, cold tap water up to the "max." marker.
- Replace the water container.

Tip: If the water container is a little high or at a slant, check whether the surface that the water container sits on is dirty. If the water container is not sitting correctly, the drain valve will not be sealed.

Clean the surface if necessary.

Filling the coffee bean container

Fill the coffee bean container with roasted espresso or coffee beans if you want to use freshly ground coffee beans for each cup of espresso or coffee.

Alternatively, you can make coffee or espresso with ready ground coffee (see "Making coffee or espresso using ready ground coffee").

Warning! Damage to the grinder!
Only put roasted coffee beans for espresso or coffee in the container. Anything else, including ground coffee, will damage the grinder.

Warning! Sugar will damage the coffee system.
Do not use coffee beans that have been treated with sugar, caramel, or other substances and do not put liquids containing sugar in the coffee bean container.

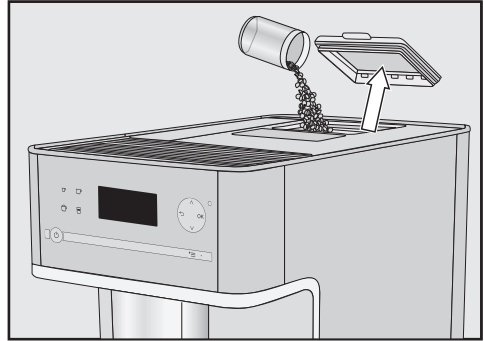

- Take the lid off the coffee bean container.
- Fill the container with roasted coffee beans.
- Replace the lid.

Tip: Only add enough beans to last for a few days as contact with air causes coffee beans to lose their aroma.

Turning the machine On / Off

Turning on

Set the main switch on the left-hand side of the machine to the "I" position.

- Touch the On/Off button .

The appliance will begin rinsing after the heating-up phase. Hot water will come out of the main dispenser.

If the coffee system still has an operating temperature higher than 140 °F (60°C), rinsing will not take place.

When "Select drink" appears in the display, drinks can be prepared.

If you do not touch any keys or run the maintenance program, the display will turn itself off after approx. 7 minutes to save energy. The right-hand LED will flash on and off as long as the machine is turned on.

Touch any one of the keys to wake the machine up again to make a drink.

Turning off

- Touch the On/Off button .

After a coffee drink has been dispensed, the pipework will be rinsed before the machine turns off.

If a drink has been made using milk, the message "Place milk pipe in drip tray" will appear in the display.

Insert the end of the milk pipe into the aperture in the drip tray, then

- Touch OK.

If the milk system is not rinsed out before turning off, it will have to be rinsed the next time the machine is turned on.

Turning off for longer periods of time

If the coffee system is not going to be used for a longer period of time:

- Empty the drip tray, the waste container and the water container.
- Clean all parts thoroughly, including the brew unit.
- Turn the machine off using the main switch.

The time of day will not be saved. It will have to be reset next time the machine is turned on.

Cups should always be pre-heated to allow the flavor of the coffee to develop and be retained.

The smaller the volume of the coffee/espresso and the thicker the cup, the more important it is to pre-heat the cup.

You can use the cup heating surface on the top of the coffee system to pre-heat coffee cups and glasses. The cup heating function must be turned on.

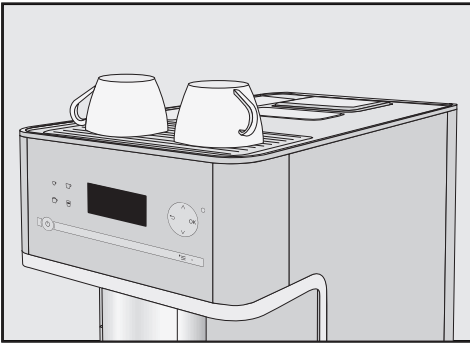

- Arrange the cups or glasses on the cup heating surface on the top of the coffee system.

The cup heating surface will be heated continually until the coffee system is turned off.

To turn cup heating on or off

- Touch .
- Select "Cup heating" and touch OK.
- Select the desired option and touch OK.

The setting is now saved.

Adjusting the coffee dispensers to the cup height

You can adjust the main dispenser to suit the height of the cup you are using so that the coffee or espresso will not cool down as quickly and the crema will have a better consistency.

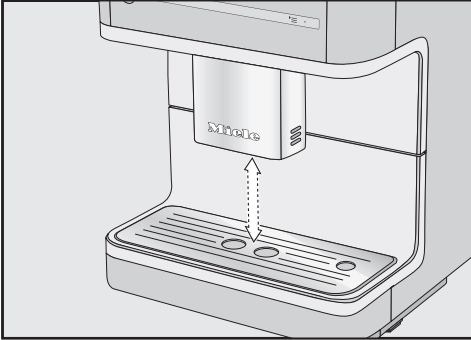

- Pull the coffee dispenser down to the same level as the rim of the cup.

or

- Push the dispenser up until there is enough room to fit a larger cup or mug underneath.

How to prepare beverages

You can choose from a variety of specialty coffees:

Ristretto is a concentrated, strong espresso. The same quantity of coffee powder as for an espresso is prepared with very little water.

Espresso is a strong, aromatic coffee with a thick hazelnut-brown cream layer – the crema – on top. Use espresso-roasted coffee beans for preparing espresso.

Coffee distinguishes itself from espresso due to the greater water quantity and the special roasting of the coffee beans.

Coffee Lungo is a coffee with significantly more water.

Coffee specialties



- Place a cup under the main dispenser.
- Touch the button for the drink you want:
 - ☐ Espresso
 - ☐ Coffee
 - ☐ in "Additional programs":
Ristretto, Coffee Lungo

The coffee or espresso will be dispensed from the main dispenser.

To ensure that any residues from the factory testing process are removed from the brewing system, please discard the first two cups of coffee when using the machine for the first time.

How to prepare beverages

Double portion

You can dispense two portions into one cup or dispense two portions into two cups at the same time.

To fill two cups at the same time:



- Place a cup under each coffee dispenser.
- Touch .

The  button will light up.

- Touch the button for the desired drink.

Two portions of the desired drink will be dispensed from the main dispenser.

Tip: If, after a while, you have not touched one of the drink buttons, the "Double portion"  option will revert back to single portions.

Canceling preparation

To cancel preparation:

- Touch the drink button that is lit up, or  for drinks from "Additional programs" again.

Tip: Drink preparation can be cancelled by pressing the OK button as soon as "Stop" appears in the display.

When making **coffee with milk** or **two portions of a drink** you can cancel each stage individually.

- Touch OK.

Drink preparation will be canceled.

How to prepare beverages

Making coffee with ground coffee

To make espresso or coffee using ready ground coffee, add a portion of ground coffee to the ground coffee chute.

This allows you to prepare a decaffeinated coffee, if the bean container is already filled with regular coffee beans for example.

The coffee system will automatically recognize that ground coffee has been placed in the chute.

Only **one** portion of coffee or espresso can be prepared at a time when using ready ground coffee.

Adding ground coffee

Use the scoop supplied with the machine to ensure the correct amount of ground coffee is used.

Do not add more than one level scoop of ground coffee to the coffee chute. If too much is added, the brew unit will not be able to process the coffee.

The coffee system will use all the ground coffee that has been added to the chute to make the next coffee.

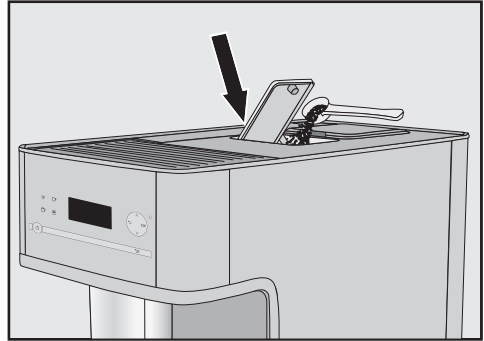

- Open the ground coffee chute.
- Add one level scoop of ready ground coffee to the chute.
- Close the coffee chute.

"Use ground coffee?" appears in the display.

How to prepare beverages

Making coffee with ready ground coffee

If you want to make a drink with pre-ground coffee:

- Select "Yes" and touch OK.

You can now select which type of drink you would like to make with ready ground coffee.

- Place a cup under the main dispenser.
- Select the desired drink.

The desired coffee drink is prepared.

If you do **not** want to make a drink with ready ground coffee:

- Select "No" and touch OK.

The ground coffee will be directed into the waste container.

If you do not touch a drink button within approx. 15 seconds, the ground coffee will also be directed into the waste container.

Drinks with milk

 Caution! Danger of burning and scalding from the main dispenser. Liquids and steam dispensed will be very hot.

Do not use milk with additives. Most additives contain sugar that will adhere to the milk pipework and damage the machine.

As soon as you select a drink containing milk, the machine will start to heat up. The milk will be drawn up into the main dispenser where it is heated by steam and also frothed for drinks requiring milk froth.

If you have not made any milk drinks for a while, rinse the milk system thoroughly before making the first drink to ensure any bacteria is flushed out.

How to prepare beverages

The following drinks with milk can be made:

Cappuccino consisting of approx. 2/3 milk froth and 1/3 espresso.

Latte macchiato consisting of 1/3 each of hot milk, milk froth and espresso.

Caffè latte consists of hot milk and coffee.

Hot milk or **milk froth** can also be made.

Notes about the stainless steel milk container

The stainless steel container keeps milk cool for longer. Good milk froth can only be made with cold milk (< 55°F/13 °C).

- Connect the stainless steel angled end of the milk tube to the top of the lid until it clicks into place.



- Place the milk container on the right-hand side of the coffee system. Connect the other end of the milk tube to the main dispenser.

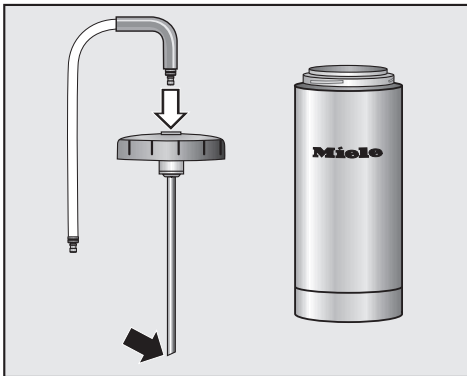

- Connect the stainless steel suction tube to the inside of the lid. Make sure that the slanted end is pointing downwards as shown.
- Fill the milk container up to max. 3/4" (2 cm) below the rim with milk. Seal the milk container with the lid.

How to prepare beverages

Using milk cartons or bottles

The milk tube for cartons and other suitable containers is located behind the machine front.

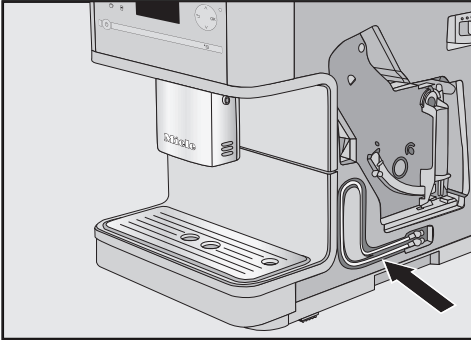

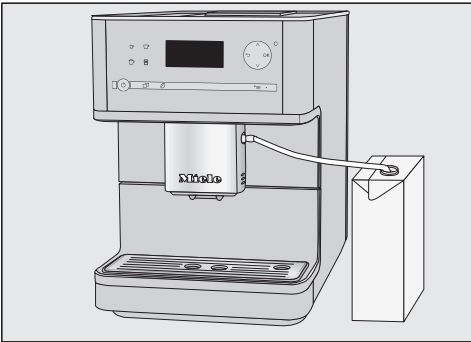

- Connect the milk pipe to the aperture in the main dispenser.



- Place a container with sufficient milk beside the coffee system on the right-hand side.
- Place the end of the milk tube in the container making sure that it is sufficiently immersed in the milk.

Preparing drinks with milk

- Place a suitable container under the main dispenser.
- Touch the button for the drink you want:

-  Cappuccino
-  Latte macchiato
-  In "Additional programs":
Caffè latte, hot milk, milk froth

The coffee system will now prepare the selected drink.

How to prepare beverages

Preparing hot water

 **Caution!** Danger of burning and scalding. The water dispensed is very hot.

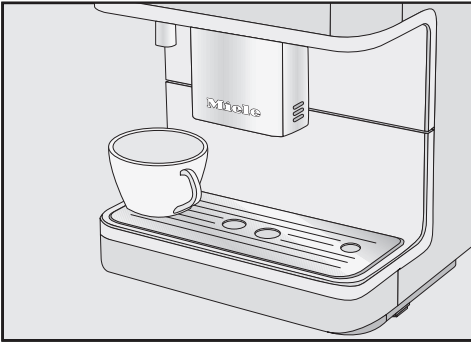

- Place a suitable container under the hot water spout.
- Touch .
- Select "Hot water" and touch OK.

Hot water is dispensed into the container under the spout.

To cancel preparation

- Touch OK.

Drink preparation will be canceled.

Preparing User profile drinks

You can enter individual profiles to suit different tastes and preferences (see "Profiles").

If you have already created your own profile, you can select this to make a drink according to your own tastes.

- Touch .
- Select the desired profile with the arrow keys and touch OK.

The name of the profile will appear in the display to show that a profile has been selected.

You can now make the drink you want.

Coffee the way you like it

You can customize your coffee system to suit the type of coffee you are using. The "Parameters" menu \odot allows you to adjust the amount of coffee that is ground, set the brew temperature and select the "Pre-brewing" option. The parameters for each type of coffee can be individually specified in the Miele profile and in any other profiles you have created.

The grinder can also be set to suit the type of coffee beans being used.

Grinder setting

When the beans are ground correctly, the coffee or espresso will flow evenly into the cup and have a good crema.

The grinder setting you select will be used for all coffee specialties.

The ideal crema has a hazelnut-brown color.

There are various ways to tell whether the coffee grinder is set correctly.

The coffee is ground **too coarse**, if

- espresso or coffee flows into the cup too quickly.
- the crema is very pale and uneven.

Set a finer grinder setting.

The coffee is ground **too fine**, if

- espresso or coffee flows into the cup very slowly.
- the crema is dark brown.

Set a coarser grinder setting.

To avoid damaging the grinder, please note the following:

Only adjust the grinder one setting at a time.

Grind the coffee beans again if you want to adjust the grinder to the next setting.

- Open the coffee system door.

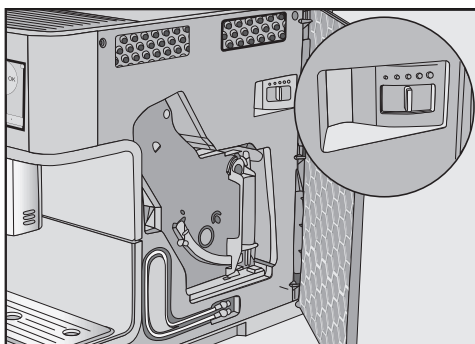

- Push the slide control one setting to the left (for finer grinding) or one setting to the right (for coarser grinding).
- Close the machine door.

When opening the service door, the internal counter for emptying the drip tray and the waste container is reset.

- Empty the drip tray **and** waste container.

- Prepare a coffee drink.

After that, you can adjust the grinder setting again.

The altered grinder setting will not be used until after the second coffee has been dispensed.

Displaying and changing the parameters of a drink

- Touch \emptyset .

The \emptyset button will light up.

- Select the desired drink and touch OK.

The current settings for the amount of coffee, brewing temperature and pre-brewing will be displayed for this drink.

Amount of coffee

The coffee system can grind and brew 6-14 g of coffee per cup. The greater the quantity, the stronger the coffee or espresso.

There are various ways to tell whether the amount of coffee is set correctly:

The amount of coffee is **too low**, if

- espresso or coffee flows into the cup too quickly.
- the crema is very pale and uneven.
- the espresso or coffee lacks body.

Increase the amount of coffee so that more ground coffee is brewed.

The amount of coffee is **too high**, if

- espresso or coffee flows into the cup very slowly.
- the crema is dark brown.
- the espresso or coffee tastes bitter.

Decrease the amount of coffee so that less ground coffee is brewed.

- Select "Amount of coffee" and touch OK.
- Use the arrow keys to change the amount.
Then touch OK.

The setting is now saved.

Tip: If the coffee is too strong for you or it tastes bitter, try another type of bean.

Coffee the way you like it

Brewing temperature

The ideal brewing temperature will depend on:

- the type of coffee,
- whether an espresso or a coffee is being prepared, and
- the altitude of the region.

If the coffee system is located at more than 6562 ft. (2000 meters) above sea level, the brewing temperature needs to be set lower due to the change in pressure. This is because the boiling point for water at a high altitude above sea level is lower than the boiling point for water at sea level.

The coffee system has five brewing temperatures.

Tip: Not all types of coffee can withstand high temperatures. Certain types are too delicate - the crema on top would not be as good and the taste would be impaired.

- Select "Brew temperature" and touch OK.
- Select the desired temperature and touch OK.

The setting is now saved.

Pre-brewing

When the pre-brewing function is turned on, the freshly ground coffee is first moistened with a little hot water. Then the remaining water is forced through the moistened coffee at high pressure. This helps release the flavor of the coffee.

You can set pre-brewing for a normal length of time or an extra long length of time. Alternatively, you can turn off the "Pre-brewing" function.

The machine is supplied with the "Pre-brewing" function turned off.

- Select "Pre-brewing" and touch OK.
- Select the setting you want and touch OK.

The setting is now saved.

The flavor of the coffee produced depends not just on the type of coffee used, but also on the amount of water used.

You can program the amount of water to suit the size of your cups and the type of coffee you are using.

For coffee drinks that use milk you can also set the amount of milk or milk froth to be dispensed with these drinks. Additionally, you can set the portion sizes for hot milk and milk froth alone.

Each type of drink has a maximum portion size that can be programmed into the machine. The coffee machine halts preparation of the coffee once this portion size has been reached. The maximum possible portion size for this type of drink is then saved in the machine.

The changed portion size is always saved in the current User profile. The name of the current profile appears in the top left-hand side of the display.

There are two ways of initiating the programming of the portion size:



- By touching the drink button when you are preparing a coffee; or
- By selecting "Portion size" in the "Parameters"  menu.

If the water container becomes empty while making a drink, the machine will stop programming the portion size. The portion size will **not** be saved.

Tip: To cancel changing the portion size, touch the drinks sensor which is lit up, or touch  for "Additional programs".

Changing the portion size during drink preparation

Portion sizes for Espresso and Coffee

- Place the desired cup under the main dispenser.
- Touch  or  until "Change" appears in the display.

The coffee system will now prepare the selected drink.



You can set the portion size as soon as "Save" appears in the display.

- When the cup is filled up to the desired level, touch OK.

From now on the programmed portion size will be dispensed for this drink.

Portion size

Portion sizes for cappuccino and latte macchiato

- Place a suitable container under the main dispenser.
- Touch  or  until the ingredients for that drink are shown in the display.

Cappuccino: milk froth, espresso

Latte macchiato: hot milk, milk froth, espresso

- Select all the components you want to change with the arrow keys. Confirm these individually with OK.

A check mark placed in front of an ingredient indicates that its quantity will be changed.

- Select "Start" and touch OK.

The coffee system will start dispensing. You can now set the portion size for each selected component as soon as "Save" appears in the display.

- When the quantity for each ingredient reaches the desired level, touch OK.
- Save the required portion size for the selected components.

The programmed mix of ingredients and portion sizes will now be dispensed every time that particular drink is selected.

Portion sizes for ristretto, coffee lungo, caffè latte, hot milk and milk froth

- Place a suitable container under the main dispenser.
- Touch .
- Select the desired drink.
- Select "Portion size" and touch OK.

You can change the amount of each component for **caffè latte** (hot milk, coffee) as described under "Portion sizes for cappuccino and latte macchiato".

For **ristretto, coffee lungo, milk froth and hot milk, proceed as described under "Setting portion sizes for espresso and coffee"**.

Changing portion sizes in the "Parameters" menu .

- Touch .
- Select the desired drink and touch OK.
- Select "Portion size" and touch OK.

From this point onwards the procedure is identical to programming the portion size during drink preparation.

Changing the portion size for different User profiles

You can set the portion size for individual drinks for each User profile.

- Touch .
- Select the User profile you want.

The name of the current profile is shown at the top left of the display.

Now you can either set the portion size by selecting "Portion size" in the "Parameters"  menu or set it during the preparation of a drink.

Profiles

If the coffee system is used by several people with different coffee preferences, you can create individual user profiles in addition to the Miele profile.

In each profile, you can make settings for individual drinks (portion size, amount of ground coffee, brewing temperature and pre-brewing).

The name of the current profile is shown at the top left of the display.

Accessing a profile

- Touch .

You can now create a User profile.

If you have allocated a profile in addition to the Miele standard profile, you have the following options:

- **Select profile** from the User profiles that have already been allocated.
- **Change name** if the name of a User profile needs to be changed.
- **Delete profile** if you want to delete a User profile.
- **Change profile** to set whether the coffee system automatically reverts to the Miele standard profile after each drink, the standard profile is active every time the machine is turned on, or whether it retains the last selected profile.

Tip: Touch  or  to return to the main menu.

Creating a profile

- Select "Create profile" and touch OK.

Letters will appear in the display that you can select with the arrow keys. You can use the arrow keys to select from numbers, upper case and lower case letters.

- Select the character you want and touch OK.

The character will then appear in the line above.

- Repeat the process until the desired name appears in the display line above.

Tip: If you make a mistake, select the  symbol to delete the last character.

When you have finished entering a name and want to **save** it,

- use the arrow keys to select the check mark  and touch OK.

If you do **not** want to save what you have entered,

- press and hold  until all characters have been deleted and the coffee system jumps back to the previous selection.

Tip: The last created profile is selected as the current profile.

Selecting a User profile

This selection is only possible if a profile has been allocated in addition to the Miele standard profile.

- Touch "Select profile" and then touch OK.
- Select the profile you want and touch OK.

The name of the profile is shown in the top left of the display.

Changing the name

This selection is only possible if a profile has been allocated in addition to the Miele standard profile.

- Select "Change name" and touch OK.

Proceed the same as with "Create profile":

- Select ↶ to delete a character.
- To enter new characters, select the relevant character and confirm with OK.
- Save the new name by selecting ✓ in the display and touching the OK sensor.

Deleting a profile

This option is only possible if a profile has already been created in addition to the standard Miele profile. The standard Miele profile cannot be deleted.

- Select "Delete profile" and touch OK.
- Select the profile you wish to delete and touch OK.

The profile will be deleted.

Profiles

Changing a profile

You can program the coffee system so that it changes back to the Miele standard profile automatically after each drink is dispensed, so that the Miele profile is always active when the machine is turned on or so that it retains the most recently selected profile.

- Select "Change profile" and touch OK.

You now have the following options:

- **Manually:** The selected profile will be retained until you select another profile manually.
 - **After each use:** The machine will change back to the Miele standard profile automatically after a drink is dispensed.
 - **When turned on:** Each time the machine is turned on it will automatically select the Miele standard profile regardless of which User profile was set before the machine was last turned off.
- Select the required option and touch OK.

You can use the "Settings" menu to customize the coffee system to suit your individual requirements.

Accessing the "Settings" menu

- Touch '☰.

Now you can check or change any settings.

The check mark ✓ next to the individual entry shows you which setting is currently active.

Touch ↶ if you want to access the previous menu.
Touch '☰ to return to the drinks selection menu.

Changing and saving settings

- Touch '☰.
- Select the desired setting with the arrow keys and touch OK.
- Touch the arrow keys until the option you want is highlighted.
- Touch OK.

The setting is now saved.

Settings

Setting options

The factory setting for the current relevant option is shown in **bold**.

Menu item	Available settings
Language	German , English, other languages Country
Time of day	Clock Format 12 h / 24 h Set
Timer	Set Turn on at / Turn off after (0:30) / Turn off at Activate Turn on at (Yes / No) / Turn off at (Yes / No)
Eco mode	On / Off
Lighting	Brightness
Info	Number of drinks Total portions / Espresso / Coffee / Cappuccino / Latte macchiato / Coffee Lungo / Caffè latte / Milk froth / Hot milk / Hot water No. of portions until appliance needs descaling No. of portions until brew unit needs degreasing
System lock	On / Off
Water hardness	Soft Medium Hard Very hard
Display brightness	–
Volume	Audio signals Keypad tone
Cup heating	On / Off
Showroom program	Demo mode (On / Off)
Factory default	Do not reset Reset

Language

You can select a language and country for all display texts.

Tip: If you select the wrong language by mistake, you can find the "Language" option by following the flag symbol .

Time of day

You can set the clock display and the time of day.

Clock Format

Available options are:

- 24-hour clock (24 hr)
- 12-hour clock (12 hr)

Set

Use the arrow keys to set the hours and minutes.

Timer

The timer offers the following options: the coffee system:

- turns on at a particular time, e.g. in the morning for breakfast ("Turn on at").
- turns off at a particular time ("Turn off at").
- turns off after a particular length of time if no keys have been pressed ("Turn off after").

For "Turn on at" and "Turn off at" to be set, the timer must be **activated**.

Turn on at:

Please note that the coffee system will **not** turn on at the time specified if you have activated the system lock.

Use the arrow keys to set the hours and minutes.

If the coffee system has turned itself on **three times** via the "Turn on at" timer function and no drinks have been dispensed, the machine will not turn itself on again automatically. This prevents the coffee machine from turning itself on unnecessarily, for example, while you are away on vacation.

Settings

The programmed times will, however, remain in memory and will be reactivated after manually turning the machine on again.

Turn off at

Use the arrow keys to set the hours and minutes.

If you have not used the coffee system for a long time, the saved times will be reactivated after manually switching the machine on again (see "Turn on at").

Turn off after

If none of the keys have been pressed or no drink has been prepared, the coffee system will turn itself off after 30 minutes to save energy.

You can change this pre-setting using the arrow keys to a time of between 15 minutes and 9 hours.

To activate and deactivate the timer

If the system lock has been activated, the timer function "Turn on at" cannot be selected.

- Select the timer function you want.

The selected option will have a next to it.

- Touch the ∇ arrow key repeatedly until "Accept" is highlighted.
Touch OK.

Eco mode

Eco mode is an energy-saving mode.

If Eco mode is turned on, the coffee system heats up anew before each drink preparation, making preparation times longer.

If Eco mode is turned off, the coffee system heats up for the first drink preparation after switching on. After that the steam system remains heated up and much more energy is used.

The coffee system will indicate the changed energy consumption.

Lighting

Change the brightness using the arrow keys.

To turn off the lighting,

- touch the ∇ arrow key until all of the segments are empty, and "Turned off" appears.

If no keys are touched or maintenance programs carried out, the lighting will turn off after approximately 7 minutes to save energy.

Info (displaying information)

In the "Info" option you can choose to display the number of prepared portions for each type of drink.

You can also see whether more than 50 portions can be dispensed before the machine needs to be descaled ("No. of portions until descaling") or before the brew unit needs to be degreased ("No. of portions until degreasing").

To return to the previous display:

- Touch OK.

Locking the coffee system (System lock)

You can lock the coffee system to prevent it being used without your knowledge, by children, for example.

Activating and deactivating the system lock

When the system lock is activated, the "Turn on at" option for the timer will not work.

Overriding the system lock temporarily

While the message "Touch OK for 6 seconds" is in the display,

- touch OK for 6 seconds.

As soon as the coffee system is turned off, the system is locked again.

Water hardness

See "Setting up and using the coffee system" for information about water hardness.

Display brightness

Change the display brightness using the arrow keys.

Volume

You can set the volume of buzzer and keypad tones using the arrow keys.

To turn off the tones,

- touch the ∨ arrow key until all of the segments are empty, and "Turned off" appears.

Cup heating

See "Pre-heating cups (cup heating)" for more information.

Settings

Factory default

You can restore the settings back to the ones that were set when the coffee system was delivered - the factory default settings.

Please refer to the "Setting options" chart for the factory settings that are shown in bold.

The following settings will **not** be reset:

- Language
- Time of day
- Number of drinks dispensed (Info)
- Profiles
- Portion size

Showroom program (demo mode)

Do not activate this setting for domestic use.

The coffee system can be presented in Miele Centers of retail stores with the "Showroom program." The lighting will come on, but drinks cannot be dispensed and other actions cannot be carried out.

If you activate the Demo mode, you cannot turn the appliance off with the On/Off button .

Quick guide

 The coffee system must be cleaned regularly to prevent a build-up of bacteria.

Recommended frequency	What do I have to clean / maintain?
Daily (before you turn the coffee system off)	Water container
	Waste container
	Drip tray and drip tray cover
	Stainless steel milk container
Once a week (or more often for very heavy soiling)	Main dispenser with cappuccinatore
	Clean the exterior (especially right after descaling)
	Remove the brew unit and wash by hand
	Inside of the coffee system
Approx. every 200 portions	Degrease the brew unit (with cleaning tablets)
Depending on the water hardness	Descal the machine
When necessary	Coffee bean container
	Ground coffee chute

Some components of the coffee system are dishwasher-safe. However, cleaning these in the dishwasher frequently can cause them to become discolored due to regular contact with food residues (e.g. tomatoes) in the dishwasher. The surface of these components can also become damaged.

The following parts must **only** be cleaned by hand:

- Brew unit
- Main dispenser cover
- Water container lid
- Bean container lid
- Stainless steel milk container
- Holder for drip tray cover (on the drip tray)

Cleaning and care

 Danger of burning and scalding on hot components or by hot liquids.

Always allow the coffee system to cool down before cleaning it.
Caution: Water in the drip tray can be very hot.

Do not use a steam cleaner to clean the coffee machine. Steam could reach the electrical components and cause a short circuit.

To avoid damaging the surfaces when cleaning, do not use any of the following:

- cleaning products containing soda, ammonia, acid or chloride,
- cleaners containing solvents,
- lime removers,
- stainless steel cleaners,
- dishwasher soap (powder),
- glass cleaning agents,
- oven cleaners,
- abrasive cleaning agents, e.g. powder cleaners and cream cleaners,
- scouring pads, such as pot scrubbers and brushes, or used sponges that still contain abrasive cleanser residue,
- eraser sponges,
- metal scrapers.

Rinsing the coffee system

After a coffee has been dispensed, the machine is rinsed before it turns off. This removes any residual coffee grounds.

You can also rinse the machine manually.

- Touch .
- Touch the ^ arrow key repeatedly until "Maintenance" is highlighted. Then touch OK.
- Select "Rinse appliance" and touch OK.

The piping will now be rinsed through.

You may also be prompted to insert the end of the milk pipe into the drip tray.

Milk pipework

Make sure that the milk pipework is cleaned regularly and thoroughly. Milk contains natural bacteria that will multiply if the pipework is not sufficiently clean. Contamination in the coffee system can be a health hazard.

Rinsing the milk pipework

Milk residue can clog up the milk pipes. If a drink has been made using milk, the coffee system will prompt you to rinse the pipework when you turn the machine off.

You can also rinse the milk pipework manually.

- Touch .
- Select "Maintenance" and touch OK.
- Select "Rinse milk pipework" and touch OK.

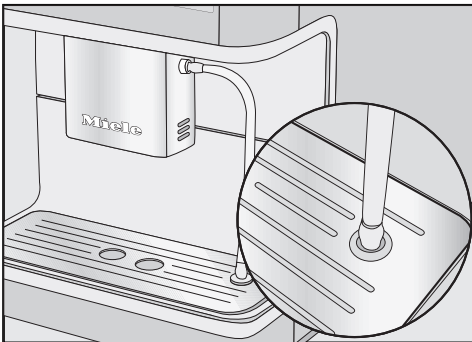

- When prompted, place the end of the milk tube into the right-hand aperture in the drip tray.
- Touch OK.

The milk pipework will now be rinsed.

Cleaning the milk pipework

The milk pipework must be cleaned at least once a week. The coffee system will prompt you when this needs to be done.

- Touch OK.

When you confirm the message "Clean milk pipework" with OK, the internal counter for the cleaning interval will be reset. You will **not** be reminded again.

There are two options:

- You can remove and dismantle the main dispenser with its integrated cappuccinatore and either wash it in the dishwasher or by hand with warm water and liquid dish soap.
- Or you can clean the milk pipework using the "Clean milk pipework" maintenance program together with the Miele cleaning agent for milk pipework.

Cleaning and care

Cleaning the milk pipework with the maintenance program

The cleaning process cannot be cancelled once it has started. The process has to be completed through to the end.

- Touch .
- Select "Maintenance" and touch OK.
- Select "Clean milk pipework" and touch OK.

The process will start.

- Follow the instructions in the display.

When the message "Place milk pipe in cleaning agent" appears in the display, dissolve the cleaning agent in water.

Making a cleaning solution:

We recommend using the Miele milk pipework cleaning agent for cleaning the milk pipework.

This has been specially developed for use with Miele coffee machines and prevents subsequent damage.

It is available from Miele dealers, Miele or the Miele website.

- Dissolve the powder in a container with approx. 1 cup (200 ml) of lukewarm water. Stir the solution with a spoon until it has fully dissolved.

Carrying out the cleaning process:

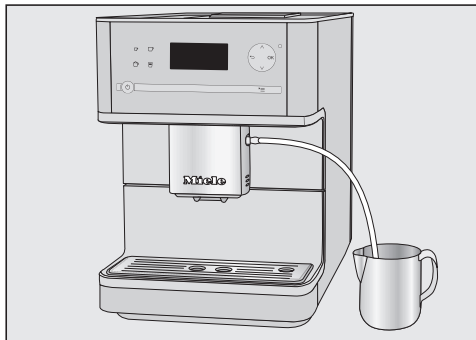

- Place the container next to the machine and hang the milk pipe in the solution. Make sure it is placed sufficiently far into the cleaning solution.
- Touch OK.
- Follow the instructions given in the display.

The cleaning process is complete when rinsing has finished.

Main dispenser with cappuccinatore

Clean the main dispenser cover **by hand** only using warm water and liquid dish soap.

All other components are dishwasher safe.

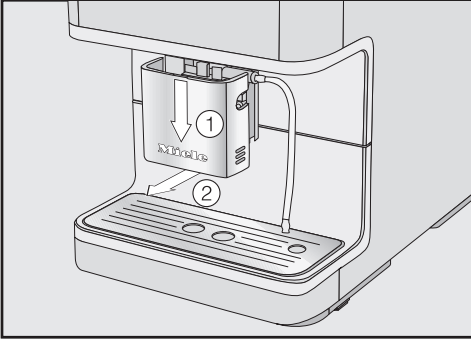

- Push the main dispenser right down and remove the stainless steel cover by pulling it off towards you.

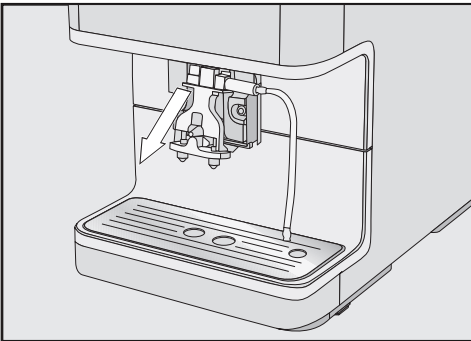

- Pull the dispensing unit off towards you.

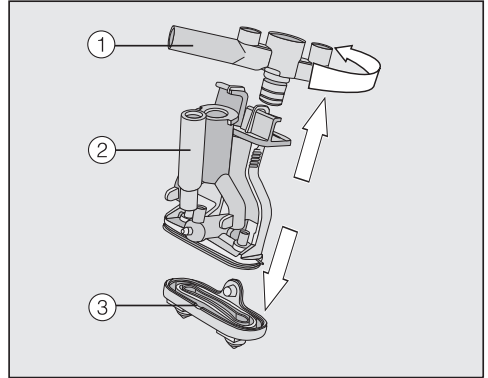

- Twist the upper section ① with the holder for the milk pipework and pull it off. Then pull the Y-shaped piece ② off. Remove the dispensing spouts ③.
- Clean all parts thoroughly.

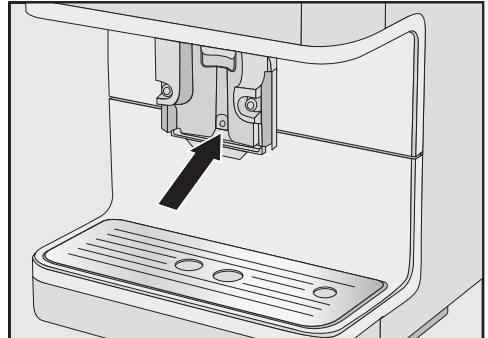

- Clean the surfaces of the main dispenser with a damp cloth.

Cleaning and care

If the milk pipe is blocked, clean it under running water with the brush supplied:

- Insert the brush in the tube and move it back and forth as far as it will go until all milk residue has been removed.
- Fit the dispensing unit back together.
- Push the dispensing unit back onto the main dispenser. Press firmly to ensure the spouts at the bottom connect correctly with the edge of the dispenser.
- Replace the stainless steel cover and connect the milk pipe if applicable.

Milk container

The milk container should be taken apart and cleaned every day.

- Clean all parts **by hand only** using warm water and liquid dish soap. Use the cleaning brush supplied to remove milk residue from the milk pipework if necessary.
- Rinse all parts carefully under running water. Residual dish soap can affect the taste of milk from the machine and the quality of the milk froth. Dry all parts afterwards.
- Reassemble the milk container.

Water container

Clean the water container lid **by hand only** using warm water and liquid dish soap.

Change the water every day to prevent a build-up of bacteria.

Make sure that the valve, the underside of the water container and the surface the water container sits on are clean. Otherwise the water container will not sit correctly.

- Press the lid on the right-hand side.
- Pull the water container up by the lid to remove it.

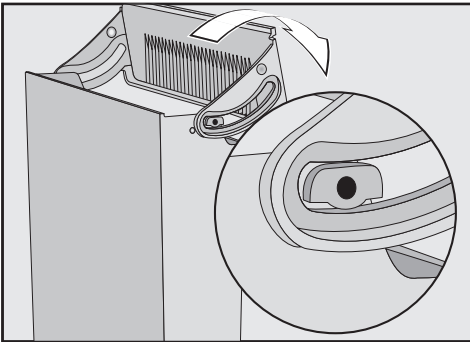

- Take the lid off the container and wash it by hand.
- The water container can be cleaned in the dishwasher, or by hand using warm water and liquid dish soap. After cleaning, dry the water container.
- Clean the surface the water container sits on, particularly the slots, carefully.
- Fit the lid back on the container.

Drip tray cover

- Remove the drip tray cover from the drip tray.
- The drip tray cover can be cleaned in the dishwasher or by hand using warm water and liquid dish soap.
- Dry the drip tray cover thoroughly.

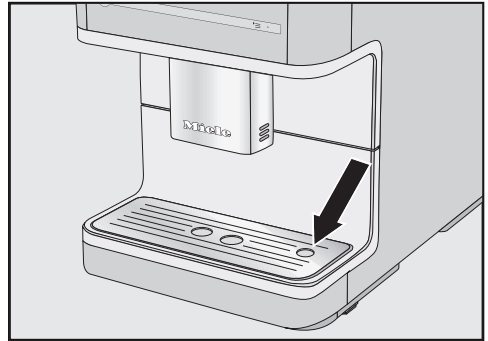

- Refit the drip tray cover making sure that the aperture for the milk tube is on the right-hand side.

Cleaning and care

Drip tray and waste container

Clean the drip tray and waste container **every day** every day to avoid unpleasant smells and mildew.

The waste container is located in the drip tray. Water from rinsing also collects in the waste container.

A prompt will appear in the coffee system display when the drip tray and/or the waste container is full and needs to be emptied. Empty the drip tray **and** the waste container.

Danger of burns.

If the rinsing process has just finished, wait a while before removing the drip tray as the water used for rinsing will run out of the coffee spouts.

- Push the main dispenser up as far as it will go.

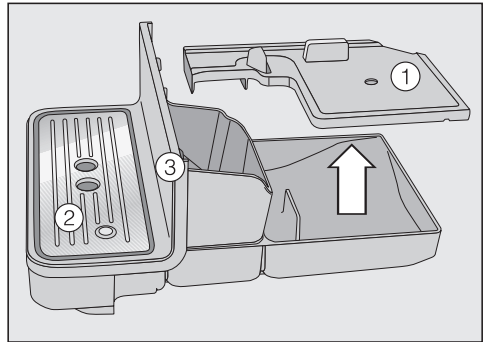

- Then pull the drip tray carefully out of the machine. Take the lid off ①.
- Empty the drip tray **and** waste container.
- Remove the drip tray cover ② and the holder ③ for the drip tray.
- Clean all parts thoroughly.

Clean the drip tray holder **by hand only** using warm water and liquid dish soap. All other parts are dishwasher-safe.

- Clean the space under the drip tray.
- Reassemble all parts and place the drip tray back in the coffee system.

Make sure the drip tray has been pushed into its niche as far as it will go.

Bean container and ground coffee chute

 Turn the coffee system off at the main switch before cleaning.

Tip: Use a vacuum cleaner to remove any coffee residues from the bean container and the ground coffee chute.

- Open the bean container.
- Remove any coffee beans.
- Clean the bean container with a dry, soft cloth.

The coffee bean container can now be refilled.

If necessary, clean the ground coffee chute:

- Open the ground coffee chute.
- Remove any ground coffee residue.

Brew unit

 Turn the coffee system off at the main switch before cleaning.

Clean the brew unit **by hand only using warm water**. Do not use liquid dish soap. The moving parts of the brew unit are lubricated. Liquid dish soap will damage the brew unit.

Clean the brew unit once a week.

Remove the brew unit and wash by hand

The brew unit can be removed for cleaning.

- Open the coffee system door.

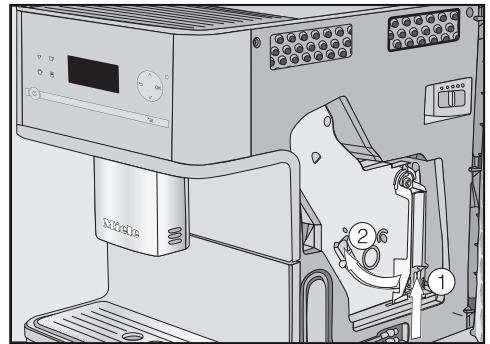

- Press the button on the end of the handle of the brew unit **①** and while doing so turn the handle counterclockwise **②**.
- Carefully pull the brew unit out of the coffee system.

Cleaning and care

If you cannot remove the brew unit or can only do so with difficulty, the brew unit is not in the correct position (See "Frequently asked questions").

When the brew unit has been pulled out, do **not** alter the position of the brew unit handle. This would displace the brew unit and it would not fit back into the coffee system.

- Clean the brew unit **by hand under hot running water** without using detergent or liquid dish soap.

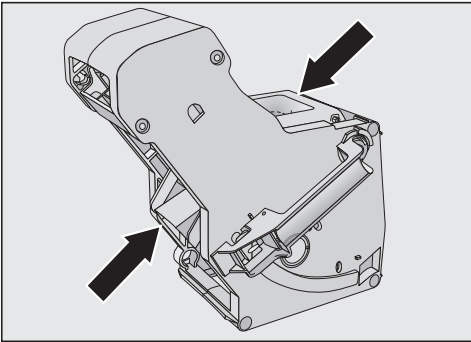

- Wipe any remaining coffee off the two filters. One filter is located in the funnel and the other to the left of the funnel.
- Dry the funnel to prevent ground coffee sticking to it the next time a coffee is prepared.
- Clean the inside of the coffee system carefully.

Make sure to remove moist ground coffee remnants regularly to prevent bacteria from forming.

Tip: Use your vacuum cleaner to remove dry coffee grounds.

To replace the brew unit, repeat the previous steps in the reverse order:

- Push the brew unit back into the coffee system, making sure it is straight.

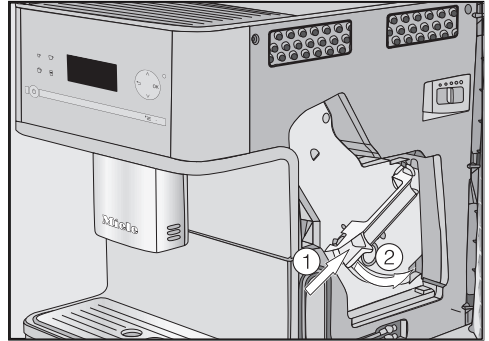

- Press the button on the end of the handle of the brew unit ① and while doing so turn the handle clockwise ②.
- Close the machine door.
- Empty the drip tray **and** waste container.

Degreasing the brew unit

Depending on the natural oil content of the coffee used, the brew unit can become blocked quite quickly. It must be degreased regularly in order to ensure aromatic coffee and trouble-free operation of the coffee system.

We recommend using Miele cleaning tablets to clean the brew unit. These have been specially developed for use with Miele coffee machines and prevent subsequent damage.

The cleaning tablets are available from Miele dealers, Miele or the Miele website.

After 200 portions have been dispensed, "Degrease the brew unit" will appear in the display.

- Touch OK.

This message will be displayed until the cleaning program has been carried out.

To degrease the brew unit:

- Touch .
- Select "Maintenance" and touch OK.
- Select "Degrease the brew unit".

The cleaning process cannot be cancelled once it has started. The process has to be completed through to the end.

- Touch OK.

The process will start.

- Follow the instructions in the display.

When "Place a cleaning tablet in the ground coffee chute and close the chute" appears in the display:

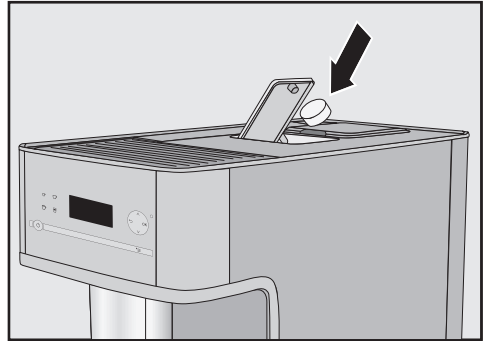

- Drop a cleaning tablet into the ground coffee chute.
- Follow the instructions given in the display.

The cleaning process is complete when rinsing has finished.

Cleaning and care

Housing

External surfaces may become discolored or damaged if soiling is left on them for too long. Remove soiling immediately.

Make sure that water cannot get behind the display.

All external surfaces are susceptible to scratching and can suffer discoloration if they come into contact with unsuitable cleaning agents.

Wipe up any spills or splashes of descaling agent immediately.

- Turn the coffee system off.
- Clean the front of the machine with a clean sponge and a solution of warm water and liquid dish soap. Dry using a soft cloth.

Tip: You can also clean the appliance front with a microfiber cloth.

Descaling the machine

Caution! When descaling the machine, cover delicate surfaces and natural flooring to prevent damage from splashes of descaling solution. Ensure that any splashes of descaling solution are wiped up immediately.

Lime scale builds up in the coffee system through use. How often the machine needs to be descaled will depend on the water hardness level in your area. It should be descaled regularly to ensure that it functions correctly.

The machine will guide you through the descaling process. Various messages will appear in the display, e.g. you will be prompted to empty the drip tray or fill the water container.

Descaling **must be carried out**.

The coffee system prompts you when it needs to be descaled. "No. of portions until appliance needs descaling: 50" appears in the display. Each time a drink is prepared, the coffee machine displays the number of portions remaining until descaling must be carried out.

■ Touch OK.

When the number of remaining portions reaches 0, the appliance will lock out. Then "Descale appliance" will appear in the display.

You can turn off the coffee system if you do not want to descale it at this time. However, you will not be able to make any more drinks until descaling has been carried out.

Descaling following display reminder

The descaling process cannot be cancelled once you have touched "OK." The process has to be completed through to the end.

To start the descaling program right away:

■ Touch OK.

The process will start.

■ Follow the instructions in the display.

When "Fill water container with lukewarm water and descaling agent up to the ☞ symbol and replace it" appears in the display, proceed as follows:

Preparing the descaling solution

We recommend using Miele descaling tablets to clean the brew unit. These have been specially developed for use with Miele coffee machines and prevent subsequent damage.

Descaling the machine

Other descaling agents, which contain other acids besides citric acid and/or other undesirable substances, such as chlorides for example, could damage the coffee system. Moreover, the descaling effect required could not be guaranteed if the descaling solution was not of the appropriate concentration.

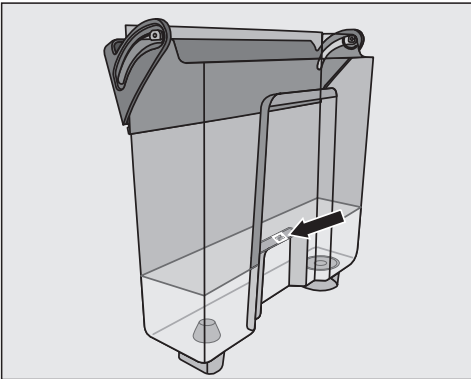

Miele descaling tablets are available to order from Miele or the Miele website.

You will need **1** descaling tablet to descale the machine.

- Fill the water container to the  symbol with lukewarm water.
- Place **1** descaling tablet in the water.

Ensure that you adhere to the mixing ratio for the descaling tablets. It is important that you do not fill the water container with too much or too little water than prescribed. The descaling program will otherwise be cancelled prematurely.

Carrying out descaling:

- Replace the water container.
- Follow the instructions given in the display.

When "Rinse the water container and fill with fresh tap water up to the descaling symbol  appears in the display:

- Carefully rinse the water container with clean water. Ensure that **no** descaling solution residue remains in the water container. Fill the water container to the  symbol with fresh tap water.

The descaling program is finished at the end of the rinsing cycle and drinks can be made again.

To protect the machine and surrounding surfaces from damage, make sure you wipe up any spillages or splashes of descaling agent immediately.

After descaling the machine carefully, rinse the water container and the drip tray to remove all traces of descaling agent.

Descaling when not prompted by a message

- Touch .
- Select "Maintenance" and touch OK.
- Select "Descale the appliance".

The descaling process cannot be cancelled once you have touched "OK." The process has to be completed through to the end.

- Touch OK.

The descaling process will begin.

Frequently Asked Questions

Most problems that occur during daily use can be easily corrected. With the help of the following guide, you will be able to find the causes of problems and rectify them.



 Important! Do not open the housing of the machine. Repairs should only be carried out by a qualified and trained person in accordance with local and national safety regulations. Unauthorized repairs could cause personal injury or machine damage.

If you cannot remedy the problem yourself, please contact Miele.

Messages in the display

Fault messages must be confirmed with OK, otherwise the message can reappear in the display even though the problem has been remedied.



- To address the fault, follow the instructions on the display.
- If the fault message appears in the display again, contact Miele.

Fault	Possible cause and solution
F1, F2 F80, F82	There is an internal fault. ■ Turn the machine off with the On/Off  button. Wait for 1 hour before turning it back on again.
F41, F42 F74, F77 F235, F236	There is an internal fault. ■ Turn the machine off with the On/Off  button. Wait for 2 minutes before turning it back on again.

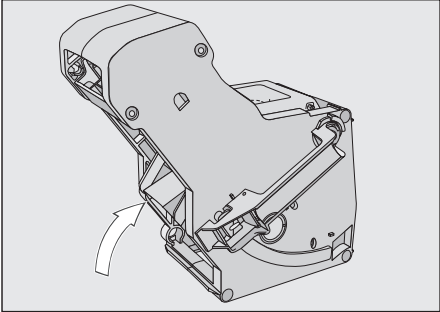

Frequently Asked Questions

Fault	Possible cause and solution
"Too much ground coffee"	<p>There is too much ready ground coffee in the ground coffee chute.</p> <p>If more than one level scoop of ground coffee is added to the coffee chute, the brew unit cannot process the coffee. The ground coffee will be directed into the waste container and the fault message will appear in the display.</p> <ul style="list-style-type: none">■ Turn the machine off with the On/Off ① button.■ Remove and clean the brew unit (see "Cleaning and care – Brew unit").■ Remove the ground coffee inside the coffee system, e.g. with a vacuum cleaner.■ Use the coffee scoop supplied to add ground coffee to the ground coffee chute. Add only one portion of ground coffee to the chute.



Frequently Asked Questions

Fault	Possible cause and solution
F73 or "Check the brew unit"	<p>The brew unit cannot be positioned correctly.</p> <ul style="list-style-type: none">■ Turn the machine off with the On/Off  button.■ Remove and clean the brew unit (see "Cleaning and care – Brew unit").  <ul style="list-style-type: none">■ Push the coffee ejector of the brew unit into the correct position (see diagram).■ Do not insert the brew unit. Close the appliance door and turn the machine on with the On/Off  sensor. <p>This will initialize the brew unit motor and put in back into the start position.</p> <ul style="list-style-type: none">■ When "Insert the brew unit" appears in the display, open the appliance door and put the brew unit back in the machine. Then close the door.

Unusual performance of the coffee system

Fault	Possible cause and solution
The lighting remains off after the coffee system has been turned on.	The lighting has been turned off. ■ Turn the lighting on (see "Settings - Lighting").
	The lamp is defective. ■ Contact Miele Service.
The display remains dark when the coffee system is turned on using the On/Off  button.	The On/Off  button was not touched for long enough. ■ Touch the On/Off  button for at least 3 seconds.
	The main switch is set to "0". ■ Set the main switch to the "I" position.
	The plug is not properly plugged into the electrical outlet. ■ Insert the plug into the electrical outlet.
	The main fuse has tripped because of a problem with the coffee system, the electricity supply or another appliance. ■ Remove the power plug from the electrical outlet. ■ Contact a qualified electrician or Miele Service for assistance.
The coffee system turns off suddenly.	The programmed turn off time has been reached. ■ If required, you can select a new turn off time (see "Settings - Timer").
	The plug is not properly plugged into the electrical outlet. ■ Insert the plug into the electrical outlet.
The coffee system is turned on. The lighting turns off suddenly.	This is not a fault. The lighting turns off approximately 7 minutes after the coffee machine was last used.

Frequently Asked Questions

Fault	Possible cause and solution
The buttons do not react to touch. The appliance cannot be operated.	<p>There is an internal fault.</p> <ul style="list-style-type: none"> ■ Disconnect the machine from the electricity supply by pulling the plug of the coffee machine from the outlet or turning off the mains fuse.
The coffee system does not turn on although the programmed and activated "Turn on at" time is activated.	<p>The system lock feature has been activated.</p> <ul style="list-style-type: none"> ■ You need to deactivate the system lock (see "Settings - System lock").
	<p>The coffee system was not used after being turned on three times in a row automatically.</p> <ul style="list-style-type: none"> ■ Turn the machine on and dispense a drink.
The display is hard to see or not legible.	<p>The display brightness has been set too low.</p> <ul style="list-style-type: none"> ■ Change this setting (see "Settings - Display brightness").
"Fill and replace the water container" appears in the display even though the water container is full and in the machine.	<p>The water tank is not sitting properly in the appliance.</p> <ul style="list-style-type: none"> ■ Remove the water container and replace it.
	<p>The water container was not correctly filled and refitted for descaling.</p> <ul style="list-style-type: none"> ■ Fill the water container to the descaling symbol  and restart the descaling program.
"Fill and replace the water container" appears after turning on even though the container is filled and fitted in the machine. The appliance does not rinse.	<p>The coffee system needs to be descaled.</p> <ul style="list-style-type: none"> ■ Turn the coffee machine off with the On/Off  button. Wait approx. 1 hour. ■ Then turn the machine on again. As soon as "Heating-up phase" appears in the display, touch  and select "Descale the appliance". ■ Descale the coffee system.

Frequently Asked Questions

Fault	Possible cause and solution
Neither milk nor milk froth comes out of the main dispenser.	<p>The milk pipework is blocked.</p> <ul style="list-style-type: none"> ■ Clean the main dispenser, taking particular care to clean the cappuccinatore and milk pipes carefully with the cleaning brush.
"Empty the drip tray" appears in the display, even though the drip tray is empty.	<p>The drip tray is not positioned correctly in the machine.</p> <ul style="list-style-type: none"> ■ Push the drip tray in as far as it will go. ■ Make sure the holder for the drip tray cover is correctly located on the drip tray.
Drink preparation has been cancelled.	<p>If the water container becomes empty while a drink is being made, the message "Water container empty. Continue? Yes / No" will appear in the display after the water container has been refilled and put back in the machine. If you do not confirm this message with "Yes" within 5 minutes, preparation will be cancelled.</p>
The coffee system does not rinse itself when turned on.	<p>This is not a fault. If the coffee system still has an operating temperature higher than 140 F (60 °C), rinsing will not take place.</p>
<p>The display lights up but the coffee system does not heat up and no drinks are made.</p> <p>The coffee system cannot be turned off with the On/Off button .</p>	<p>The demo setting of the coffee system for showrooms or dealers has been activated.</p> <ul style="list-style-type: none"> ■ Deactivate the Demo mode (see "Settings - Demo mode").
"Fill the bean container" appears in the display even though the bean container is full.	<p>This is not a fault.</p> <ul style="list-style-type: none"> ■ Confirm the message with OK.

Frequently Asked Questions

Fault	Possible cause and solution
<p>The preparation of coffee drinks is cancelled repeatedly and the message "Fill bean container" appears.</p>	<p>This is not a fault.</p> <p>The brew unit does not sense the ground coffee. With particular types of coffee, it can happen that too little coffee is ground or the ground coffee is too fine. Usually the grinding – fine and the ground coffee quantity – are set too low.</p> <ul style="list-style-type: none"> ■ Confirm the message with OK. <p>Tip: If the coffee is too strong for you or it tastes bitter, try another type of bean.</p> <p>If the message appears during the preparation of all coffee specialties:</p> <ul style="list-style-type: none"> ■ Set the grinder to a coarser setting (see "Setting the coffee grinder"). ■ Check the settings for the grinding quantity for all coffee specialties (see "Setting the coffee grinder"). If necessary, select a larger quantity to grind. <p>Also consider any changed drinks in "Profiles" .</p> <p>If the message only appears during the preparation of selected coffee specialties:</p> <ul style="list-style-type: none"> ■ Check the settings for the grinding quantity for this coffee specialty (see "Setting the coffee grinder"). Select a larger quantity to grind. ■ If necessary, you should also set the grinder to a coarser setting.
<p>Drink preparation begins even though no button was touched.</p>	<p>Condensate may have built up on the control panel and accidentally started the process.</p> <ul style="list-style-type: none"> ■ Wipe any condensate off with a soft cloth.

Frequently Asked Questions

Fault	Possible cause and solution
Milk is dripping out of the cappuccinatore even though no milk is being dispensed.	<p>The level of milk in the milk container is higher than the cappuccinatore.</p> <ul style="list-style-type: none"> ■ Push the main dispenser up as far as it will go.
The descaling program was started unintentionally.	<p>The descaling program cannot be stopped once the OK sensor has been touched.</p> <p>Descaling must be continued through to completion. This is a safety precaution to make sure the machine is descaled correctly.</p>
Loud noises are heard during the descaling program.	<p>This is not a fault.</p> <p>These noises occur when water is flushed through the machine at a high pressure.</p>
The heating-up time is getting longer, the amount of water being dispensed is incorrect and the coffee machine is not performing properly.	<p>The coffee system needs to be descaled.</p> <ul style="list-style-type: none"> ■ Descale the coffee system (see "Descaling").
Coffee or espresso is not flowing out of the main dispenser, or coffee is only being dispensed via one spout.	<p>The main dispenser has a blockage.</p> <ul style="list-style-type: none"> ■ Clean the coffee pipework (see "Cleaning and care - Rinsing the machine"). <p>If, having rinsed the machine, espresso or coffee still cannot be dispensed or only flows out of one spout:</p> <ul style="list-style-type: none"> ■ Dismantle the main dispenser and clean all parts carefully (see "Cleaning and care - Main dispenser with integrated cappuccinatore"). ■ Make sure all parts are reassembled correctly.

Frequently Asked Questions

Fault	Possible cause and solution
<p>After turning on the machine a message appears prompting you to empty the drip tray and the waste container even though they are empty.</p>	<p>This is not a fault. The drip tray and waste container was probably not emptied after making the last coffee, or the internal counter was not reset.</p> <ul style="list-style-type: none"> ■ Remove the drip tray and waste container from the machine and empty them.
<p>"Empty the drip tray and the waste container" appears in the display even though both are inserted in the machine.</p>	<p>The drip tray is not correctly fitted and is therefore not detected.</p> <ul style="list-style-type: none"> ■ Empty the drip tray and the waste container. Reassemble all parts and place the drip tray and the waste container back in the coffee system.
	<p>The service door is open.</p> <ul style="list-style-type: none"> ■ Close the service door. ■ If necessary, empty the drip tray and the waste container. Reassemble all parts and place the drip tray and the waste container back in the coffee system.
<p>The drip tray or the waste container is too full or runs over although the drip tray and the waste container were emptied after each message on the display.</p>	<p>This is not a fault. The drip tray and waste container were probably pulled out or the service door opened without emptying the drip tray and the waste container. When pulling out the drip tray or opening the service door, the internal counter for the emptying of the drip tray and waste container are reset.</p> <ul style="list-style-type: none"> ■ Remove the drip tray and waste container from the machine and empty them.

Unsatisfactory results

Fault	Possible cause and solution
The consistency of the milk froth is unsatisfactory.	<p>The milk temperature is too high. Good milk froth can only be achieved when cold milk (below < 55°F/13 °C) is used.</p> <ul style="list-style-type: none"> ■ Check the temperature of the milk.
	<p>The milk pipework is blocked.</p> <ul style="list-style-type: none"> ■ Clean the main dispenser with integrated cappuccinatore and the milk pipework with the cleaning brush.
The coffee grinder makes a louder noise than usual.	<p>The coffee bean container has become empty during the grinding process.</p> <ul style="list-style-type: none"> ■ Fill the coffee bean container with fresh beans.
	<p>There may be stones in among the coffee beans.</p> <ul style="list-style-type: none"> ■ Turn the coffee system off immediately. Contact Miele.
Espresso or coffee flows into the cup too quickly.	<p>The grind level is too coarse.</p> <ul style="list-style-type: none"> ■ Set the grinder to a finer setting (see "Setting the coffee grinder").
Espresso or coffee flows too slowly into the cup.	<p>The grind level is too fine.</p> <ul style="list-style-type: none"> ■ Set the grinder to a coarser setting (see "Setting the coffee grinder").
The coffee or espresso is not hot enough.	<p>The cup has not been pre-heated.</p>
	<p>The brewing temperature is set too low.</p> <ul style="list-style-type: none"> ■ Set a higher brewing temperature (see "Brewing temperature").
	<p>The brew unit filters are blocked.</p> <ul style="list-style-type: none"> ■ Remove and clean the brew unit (see "Cleaning and care – Brew unit"). ■ Degrease the brew unit (see "Cleaning and care - Brew unit").

Frequently Asked Questions

Fault	Possible cause and solution
The crema on the coffee or espresso is "not right".	The grinder setting is not correct. ■ Set the grinder to a finer or coarser setting (see "Setting the coffee grinder").
	The brew temperature is too high for the type of coffee being used. ■ Set a lower brewing temperature (see "Brewing temperature").
	The coffee beans are no longer fresh. ■ Add fresh beans to the coffee bean container.

If the coffee system will not be used for an extended period of time, e.g. vacation, or will be transported over a long distance, the machine should be prepared as follows.

Please note:

- Empty and clean the coffee bean container
- Empty and clean the water container
- Evaporating the coffee system
- Clean the drip tray and waste container
- Pack the machine securely

Evaporating the coffee system

The coffee system should be evaporated before it is stored for a long period of time or transported any distance - particularly at temperatures below freezing.

Evaporating the machine involves removing all traces of water from the system to prevent the risk of water and frost damage.

- Turn the coffee system on with the On/Off  button.

- Touch .

- Touch  twice.

"Empty the system?" will appear in the display.

- Select "Yes" and touch OK.
- Follow the instructions in the display.

 Caution! Hot steam will be release from the hot water dispenser
- Danger of burns!

The evaporation process is finished when "Process complete" appears in the display.

- Turn the machine off using the main switch.
- Clean the drip tray and waste container.

The coffee system is now ready to be packed.

Packing

The coffee system should only be packed when it is clean and dry. Residues of coffee grounds can cause scratches on surfaces. Coffee and milk residues or water can cause a build-up of bacteria.

Use the original packaging including Styrofoam to pack the coffee system.

Also pack the operating instructions so that they are available when the coffee system is next used.

Technical service and warranty

In the event of a malfunction that you cannot correct yourself, please contact

– Your Miele dealer

or

– the Miele Technical Service Department.

The telephone number for the Technical Service Department is listed at the back of these instructions.

When contacting Miele, please quote the model and serial number of your machine. This information is given on the data plate located behind the drip tray in the machine.

Warranty

For further information, please refer to your warranty booklet.

If the default settings for "Eco mode" or the "Timer" have been altered, the coffee system's energy consumption will increase.

The message "This setting uses more energy" will appear in the display.

Pre-heating cups with hot water

If you only want to pre-heat your cups occasionally, you can turn the cup heating surface off.

You can then use hot water to pre-heat the cups.

Turning the coffee system off with the main switch

If the coffee system is not going to be used for a longer period of time, e.g. during a vacation, turn it off with the main switch.

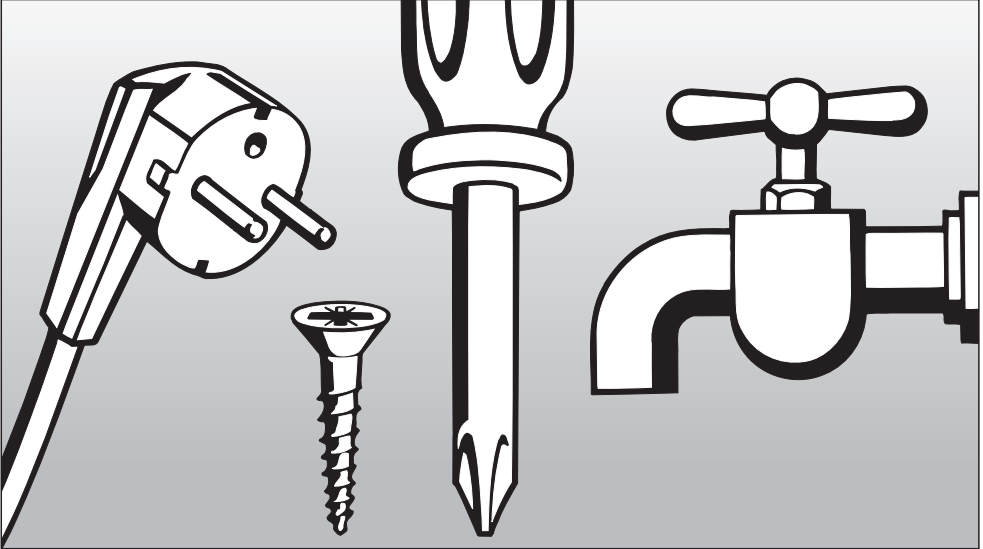

Installation instructions

Information is subject to change. Please refer to our website to obtain the most current product specification, technical & warranty information.

Leave these instructions with the appliance for the consumer/user.

Information is subject to change. Please refer to our website to obtain the most current product specification, technical & warranty information.

Packaging material / Disposal of old machine

Packaging material

The packing materials protect the appliance during shipping.

The original box and polystyrene pieces can be saved to transport the machine in the future.

The original packaging should also be kept in case the machine ever needs to be returned to Miele for servicing.

Disposal of your old appliance

Old electric and electronic appliances may contain materials that can be recycled.

Please contact your local recycling authority about the possibility of recycling these materials.

Please be sure that your old appliance does not pose a danger to children while being stored for disposal.

All electrical work should be performed by a qualified electrician in strict accordance with national and local safety regulations. Installation, repairs and other work by unqualified persons could be dangerous.

Verify that the voltage, load and circuit rating information found on the data plate match the household electrical supply. This data must match to prevent damage to the coffee system. If in doubt, consult a licensed electrician.

The data plate can be found behind the drip tray inside the coffee system.

The appliance is supplied with a power cable ready for connection to an AC 120 V 60 Hz supply.

Connect the coffee system only to a properly installed outlet with grounding contact.

Fuse rating must be at least 15 A.

The socket should be next to the appliance and easily accessible.

To reduce the risk of injury, do not drape cord over the counter top or table top where it can be pulled on by children or tripped over unintentionally.

Do not connect the appliance to a power inverter or directly to power produced outside of the normal electrical grid (i.e. direct solar or wind power source).

Direct connection to such power sources can cause power surges and tripped breakers when the appliance is turned on, and could damage the appliance.

Do not connect the appliance to energy saving plugs or outlets. The reduction of power to the appliance caused by these devices will cause the appliance to run hot and may damage it and/or shorten its usable life.

Do not operate any appliance with a damaged cord or plug. Contact Miele Technical Service.

Push it up through the opening at the back of the machine.

If there is any question concerning the electrical connection of this appliance to your power supply, please consult a licensed electrician or contact Miele's Technical Service Department.

**WARNING:
THIS APPLIANCE MUST BE
GROUNDED**

Installation

Please observe the following installation instructions:

Danger of overheating!
Please ensure that there is adequate ventilation around the machine. Do not cover the machine with tea towels or similar objects while it is in use.

Danger of overheating!
If the coffee system is installed behind a kitchen furniture door, it may only be used with the furniture door open. Do not close the furniture door while the coffee system is in use.

- The location of the machine must be dry and well ventilated.
- The ambient temperature of the room in which the machine is used must be between +50 °F / 10 °C and +100 °F / 38 °C.
- The coffee system must be set up on a level surface. The surface must be water resistant.

If the coffee system is installed in a niche, the niche must provide the following minimum dimensions:

Height	20" (508 mm)
Width	17 11/16" (450 mm)
Depth	21 7/8" (555 mm)

When setting up the machine: make sure that the front of the machine can be fully opened so that the brew unit can be removed with ease when required.

- The machine must be set up in the niche such that it sits flush with the front edge of the niche.

Appliance dimensions

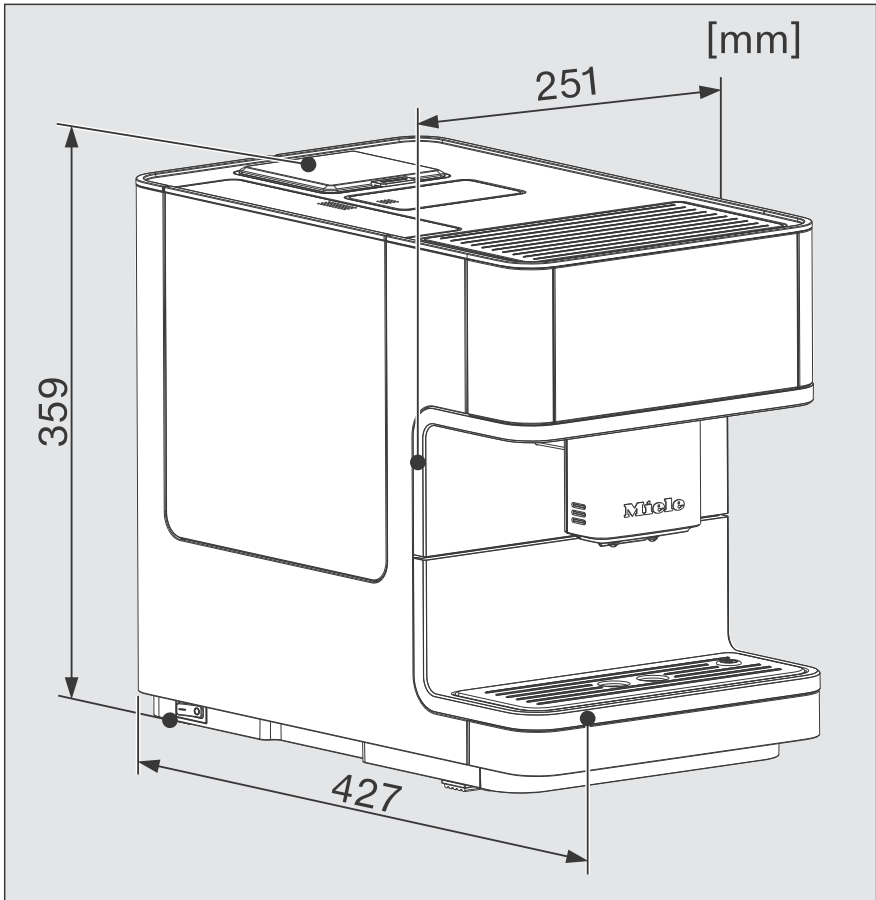

Appliance dimensions

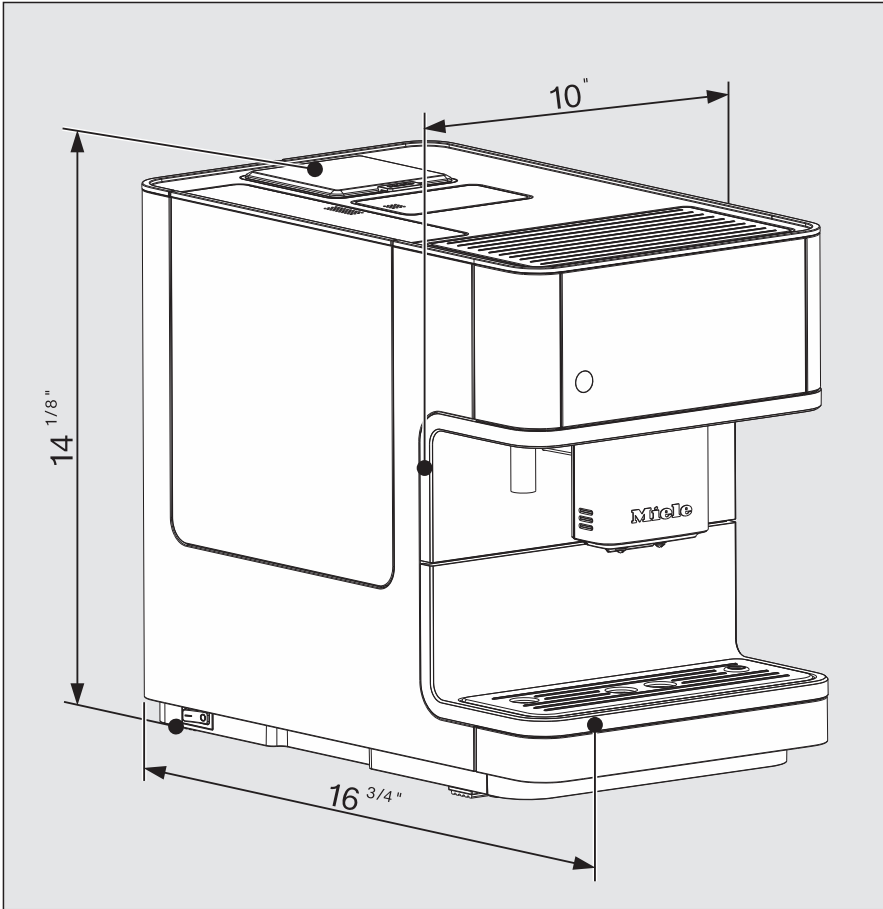

Technical details

Current draw in standby mode (default setting):	< 0.5 Watt
Pump pressure:	max. 217 psi (15 bar)
Through-flow heater:	1 stainless steel thermo block
Appliance dimensions (W x H x D):	10 " x 14 1/8 " x 16 3/4 "
Net weight:	22 lbs (9.9 kg)
Connection cable length:	55" (140 cm)
Water container capacity:	approx. 7 1/2 cups (1.8 l)
Bean container capacity:	approx. 0.6 lbs (300 g)
Stainless steel milk container capacity:	approx. 2 cups (0.5 l)
Waste container capacity:	max. 10 portions of coffee grounds
Main dispenser:	Height adjustable from 3 1/4" - 5 1/2" (80 - 140mm) mm
Grinder:	Stainless steel mill
Grinder setting:	5 settings
Ground coffee amount:	max. approx. 0.4 ounces (12 g)

Please have the model and serial number of your appliance available before contacting Technical Service.

U.S.A.

Miele, Inc.

National Headquarters

9 Independence Way
Princeton, NJ 08540
Phone: 800-843-7231
609-419-9898
Fax: 609-419-4298
www.mieleusa.com

Technical Service & Support Nationwide

Phone: 800-999-1360
Fax: 888-586-8056
TechnicalService@mieleusa.com

Miele

Canada

Importer
Miele Limited

Headquarters and Miele Centre

161 Four Valley Drive
Vaughan, ON L4K 4V8
www.miele.ca

Customer Care Centre

Phone: 800-565-6435
905-532-2272
customercare@miele.ca

Germany

Manufacturer
Miele & Cie. KG
Carl-Miele-Straße 29
33332 Gütersloh



CM 6110, CM 6310