

1. INSTRUCTIONS FOR USE.....	28
2. SAFETY PRECAUTIONS.....	30
3. ENVIRONMENTAL CARE	32
4. DESCRIPTION OF CONTROLS	33
5. USING THE HOB	34
6. CLEANING AND MAINTENANCE	38
7. POSITIONING IN THE COUNTER TOP	40
8. ELECTRICAL CONNECTION	43
9. GAS CONNECTION.....	44
10. ADAPTATION TO DIFFERENT TYPES OF GAS	46

THESE INSTRUCTIONS ARE VALID ONLY FOR THE DESTINATION COUNTRIES WHOSE IDENTIFYING SYMBOLS ARE INCLUDED ON THE COVER OF THIS MANUAL.



INSTRUCTIONS FOR THE USER: these contain user advice, the description of the controls and the correct procedures for cleaning and maintenance of the appliance.



INSTRUCTIONS FOR THE INSTALLER: these are intended for the qualified technician who must install the appliance, set it functioning and carry out an inspection test.



Further information about the products can be found at www.smeg.com



1. INSTRUCTIONS FOR USE



THIS MANUAL IS AN INTEGRAL PART OF THE APPLIANCE. IT MUST BE KEPT IN ITS ENTIRETY AND IN AN ACCESSIBLE PLACE FOR THE WHOLE WORKING LIFE OF THE COOKING HOB. WE ADVISE YOU TO READ THIS MANUAL AND ALL THE INFORMATION IT CONTAINS CAREFULLY BEFORE USING THE HOB. ALSO KEEP THE SERIES OF NOZZLES PROVIDED. INSTALLATION MUST BE CARRIED OUT BY QUALIFIED PERSONNEL IN ACCORDANCE WITH THE REGULATIONS IN FORCE. THIS APPLIANCE IS INTENDED FOR HOUSEHOLD USE AND COMPLIES WITH THE EEC DIRECTIVES CURRENTLY IN FORCE. THE APPLIANCE HAS BEEN BUILT TO CARRY OUT THE FOLLOWING FUNCTIONS: COOKING AND HEATING FOODS; ALL OTHER USES ARE TO BE CONSIDERED IMPROPER.

THE MANUFACTURER CANNOT BE HELD LIABLE FOR USES OTHER THAN THOSE INDICATED.



IF THE APPLIANCE IS INSTALLED ON BOATS OR IN CARAVANS, DO NOT USE IT AS A ROOM HEATER.



DO NOT USE THIS APPLIANCE FOR HEATING ROOMS.



THIS APPLIANCE IS MARKED ACCORDING TO EUROPEAN DIRECTIVE 2002/96/EC ON WASTE ELECTRICAL AND ELECTRONIC EQUIPMENT (WEEE).

THIS DIRECTIVE DEFINES THE STANDARDS FOR THE COLLECTION AND RECYCLING OF WASTE ELECTRICAL AND ELECTRONIC EQUIPMENT APPLICABLE THROUGHOUT THE EUROPEAN UNION.



BEFORE THE APPLIANCE IS PUT INTO OPERATION, ALL PROTECTIVE FILMS MUST BE REMOVED.



SUITABLE HEAT-PROOF GLOVES SHOULD BE WORN FOR ALL OPERATIONS.



DO NOT USE STEEL SPONGES AND SHARP SCRAPERS AS THEY WILL DAMAGE THE SURFACE.

USE ORDINARY NON-ABRASIVE PRODUCTS, INCLUDING WOODEN OR PLASTIC UTENSILS IF NECESSARY. RINSE THOROUGHLY AND DRY USING A SOFT CLOTH OR A MICROFIBRE CLOTH.



DO NOT LEAVE THE APPLIANCE UNATTENDED DURING COOKING OPERATIONS WHERE FATS OR OILS COULD BE RELEASED. FATS AND OILS MAY CATCH FIRE.



General instructions

GB-IE



ALWAYS CHECK THAT THE CONTROL KNOBS ARE IN THE  (OFF) POSITION WHEN YOU FINISH USING THE HOB.



NEVER PLACE PANS WITH BOTTOMS WHICH ARE NOT PERFECTLY FLAT AND SMOOTH ON THE COOKING HOB PAN STANDS.



NEVER USE CONTAINERS WHICH PROJECT BEYOND THE OUTSIDE EDGE OF THE HOB.



2. SAFETY PRECAUTIONS

CONSULT THE INSTALLATION INSTRUCTIONS FOR SAFETY STANDARDS ON ELECTRICAL OR GAS APPLIANCES AND FOR VENTILATION FUNCTIONS.

IN YOUR INTERESTS AND FOR YOUR SAFETY THE LAW REQUIRES THAT THE INSTALLATION AND SERVICING OF ALL HOUSEHOLD APPLIANCES IS CARRIED OUT BY QUALIFIED PERSONNEL IN ACCORDANCE WITH THE REGULATIONS IN FORCE.

OUR APPROVED INSTALLERS GUARANTEE A SATISFACTORY JOB.

GAS OR ELECTRICAL APPLIANCES MUST ALWAYS BE DISCONNECTED BY SUITABLY SKILLED PEOPLE.



BEFORE CONNECTING THE APPLIANCE TO THE POWER GRID, CHECK THE DATA ON THE PLATE AGAINST THE DATA FOR THE GRID ITSELF.



THE IDENTIFICATION PLATE CONTAINING THE TECHNICAL DATA, SERIAL NUMBER AND BRAND NAME IS IN A VISIBLE POSITION UNDER THE CASING.

DO NOT REMOVE THE PLATE ON THE CASING FOR ANY REASON.

BEFORE CONNECTING THE APPLIANCE, ENSURE THAT IT IS SET TO THE TYPE OF GAS THAT IT WILL BE SUPPLIED WITH, CHECKING THE LABEL APPLIED UNDER THE CASING.



BEFORE CARRYING OUT INSTALLATION/MAINTENANCE WORK, MAKE SURE THAT THE APPLIANCE IS NOT CONNECTED TO THE POWER GRID.



THE PLUG TO BE CONNECTED TO THE POWER SUPPLY CABLE AND ITS SOCKET MUST BE OF THE SAME TYPE AND CONFORM TO THE REGULATIONS IN FORCE.

THE SOCKET MUST BE ACCESSIBLE AFTER THE APPLIANCE HAS BEEN BUILT IN. NEVER UNPLUG BY PULLING ON THE CABLE.



IF THE POWER SUPPLY CABLE IS DAMAGED, CONTACT THE TECHNICAL ASSISTANCE CENTRE IMMEDIATELY AND THEY WILL REPLACE IT.



THE APPLIANCE MUST BE CONNECTED TO EARTH IN COMPLIANCE WITH ELECTRICAL SYSTEM SAFETY REGULATIONS.



IMMEDIATELY AFTER INSTALLATION, CARRY OUT A BRIEF INSPECTION TEST, FOLLOWING THE INSTRUCTIONS BELOW. SHOULD THE APPLIANCE NOT FUNCTION, DISCONNECT IT FROM THE POWER SUPPLY AND CALL THE NEAREST TECHNICAL ASSISTANCE CENTRE.

NEVER ATTEMPT TO REPAIR THE APPLIANCE.



DURING USE THE APPLIANCE BECOMES VERY HOT. TAKE CARE NOT TO TOUCH THE HEATING ELEMENTS.



General instructions

GB-IE



THE USE OF THIS APPLIANCE IS NOT PERMITTED TO PEOPLE (INCLUDING CHILDREN) OF REDUCED PHYSICAL AND MENTAL ABILITY, OR LACKING IN EXPERIENCE IN THE USE OF ELECTRICAL APPLIANCES, UNLESS THEY ARE SUPERVISED OR INSTRUCTED BY ADULTS OR PEOPLE RESPONSIBLE FOR THEIR SAFETY.



DO NOT LET CHILDREN GO NEAR THE APPLIANCE WHEN IT IS IN OPERATION OR PLAY WITH IT AT ANY TIME.



DO NOT INSERT POINTED METAL OBJECTS (CUTLERY OR UTENSILS) INTO THE SLOTS IN THE APPLIANCE.



DO NOT USE STEAM JETS FOR CLEANING THE APPLIANCE.
THE STEAM COULD REACH THE ELECTRONICS, DAMAGING THEM AND CAUSING SHORT-CIRCUITS.



DO NOT MODIFY THIS APPLIANCE.



DO NOT SPRAY ANY SPRAY PRODUCTS NEAR THE HOUSEHOLD APPLIANCE WHILE IT IS IN OPERATION.
DO NOT USE SPRAY PRODUCTS WHILE THE PRODUCT IS STILL HOT.



The manufacturer declines all responsibility for damage to persons or things caused by non-observance of the above prescriptions or by interference with any part of the appliance or by the use of non-original spare parts.



3. ENVIRONMENTAL CARE

3.1 Our environmental care



Pursuant to Directives 2002/95/EC, 2002/96/EC, 2003/108/EC, relating to the reduction of the use of hazardous substances in electrical and electronic appliances, as well as to the disposal of refuse, the crossed out bin symbol on the appliance indicates that the product, at the end of its useful life, must be collected separately from other refuse. Therefore, the user must consign the product that has reached the end of its working life to the appropriate selective collection centres for electrical and electronic refuse, or deliver it back to the retailer when purchasing an equivalent product, on a one for one basis. Adequate selective collection for the subsequent forwarding of the decommissioned product to recycling, treatment and ecologically compatible disposal contributes to avoiding possible negative effects on the environment and on health and promotes the recycling of the materials of which the appliance consists. The illicit disposal of the product by the user results in the application of administrative sanctions.

The product does not contain substances in quantities sufficient to be considered hazardous to health and the environment, in accordance with current European directives.

3.2 Your environmental care

Our product's packaging is made of non-polluting materials, therefore compatible with the environment and recyclable. Please help by disposing of the packaging correctly. You can obtain the addresses of collection, recycling and disposal centres from your retailer or from the competent local organisations.



Do not discard the packaging or any part of it, or leave it unattended. It can constitute a suffocation hazard for children, especially the plastic bags.

Your old appliance also needs to be disposed of correctly.

Important: hand over your appliance to the local agency authorised for the collection of household appliances no longer in use. Correct disposal enables intelligent recovery of valuable materials.

Before disposing of your appliance it is important to remove doors and leave shelves in the same position as for use, to ensure that children cannot accidentally become trapped inside during play. It is also necessary to cut the connecting cable to the power grid, removing it along with the plug.



4. DESCRIPTION OF CONTROLS

4.1 Control zone

All the hob controls are grouped together on the front panel.

CONTROL ZONE





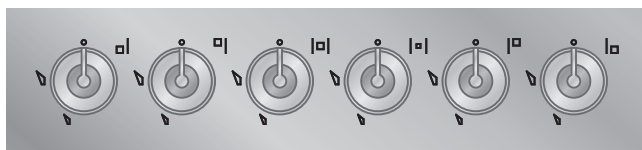

4-burner hob



5-burner hob

KNOB DESCRIPTION

To light the flame, press the knob and turn it anti-clockwise to between the maximum  and the minimum flame symbol . To adjust the flame, turn the knob to the area between the maximum  and minimum settings . To turn off the burner, return the knob to position .





ARRANGEMENT OF BURNERS AND DESCRIPTION OF SYMBOLS

5-burner hob

 Front left Burner

 Central external Burner

 Front right Burner

 Rear left Burner

 Central internal Burner

 Rear right Burner

4-burner hob

 Left burner

 Rear central Burner

 Right burner

 Front central Burner



5. USING THE HOB



Before lighting the burners, make sure that the burners, flame-spreader crown, burner caps and pan stands are fitted correctly.

The igniters and thermocouples **B**, on the hob should be inserted into the holes **A** in the flame-spreader crowns.

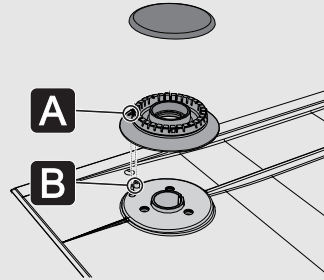

5.1 Positioning the pan stands



The pan stands are provided unassembled on the hob. The list of available pan stand types are listed below.

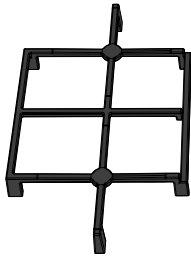

Side pan stands (5 burners)

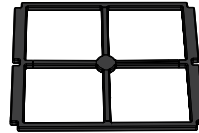

Central pan stand (5 burners)

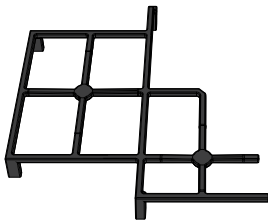

Left/right pan stand (4 burners)



To position each pan stand correctly on its burner, follow the instructions below:

5-burner hob

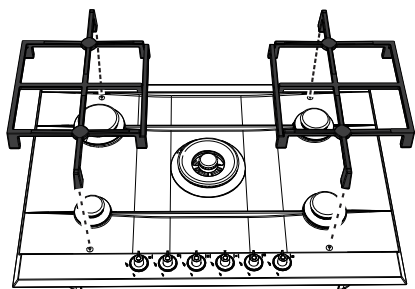

Place the side pan stands as shown in the figure.

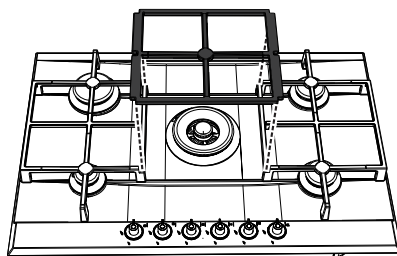

Then place the central pan stand resting it on the side pan stands.

4-burner hob

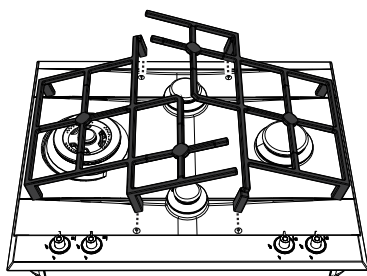

Place the pan stands as shown in the figure.



At the ends of the feet of the pan stands there are silicone rests with a hole that must be centred onto the matching fixing pins on the hob.

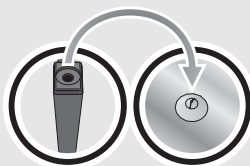

Make sure that the pan stands are simply centred on their respective burners, without forcing the burners to be raised or tilted. If they are, repeat the positioning procedure.



If you find that a pan is particularly unstable, make sure that the pan stands have not been positioned incorrectly.



5.2 Lighting the burners using a safety device



The burner controlled by each knob is shown next to the knob (the example to the left corresponds to the front left burner).

The appliance is equipped with electronic ignition. Simply press the knob and simultaneously turn it anticlockwise to the minimum flame symbol, until it lights. Hold down the knob for about 2 seconds to keep the flame lit and to activate the safety device. The burner may go out when the knob is released. If this happens, repeat the procedure, holding the knob down for longer.

(On some models only)

Double-crown burners comprise an auxiliary and a rapid burner, controlled by two different knobs which permit to use both burners at the same time or to select one or the other as required.

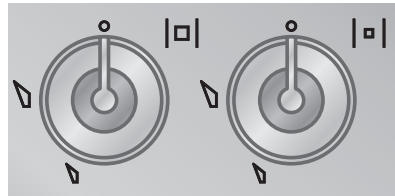

If the burners should go out accidentally, after about 20 seconds a safety device will be tripped, cutting off the gas supply, even if the gas tap is open. In this case, turn the knob to the OFF position and wait at least 60 seconds before trying to light the burner again.

5.3 Practical tips for using the burners

For better burner performance and minimum gas consumption, pans with flat, even bases and with lids should be used, and their size should be in proportion to the burner (see “5.2 Lighting the burners using a safety device”).

During cooking, in order to avoid burns or damage to the counter top and to the glass lid (when present), all pans or griddles must be positioned within the cooking hob perimeter and a minimum distance of 3-4 cm must be maintained from the knobs.

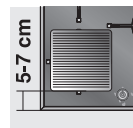



5.4 Pan diameters

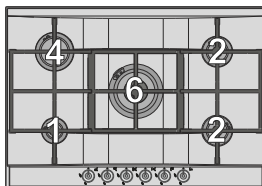
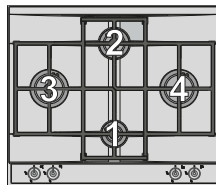
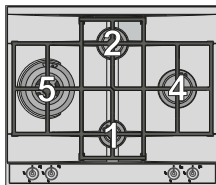

(*)	Burner	min. and max. Ø (in cm)
1	Auxiliary	7 - 18
2	Semi-rapid	10 - 24
3	Rapid	14 - 26
4	Reduced rapid	12 - 24
5	Ultra-rapid	12 - 28
6	Double crown	12 - 24



- Do not use griddles or plates to cook or heat food on the ultra-rapid/triple crown burner;
- Do not place aluminium foil under the burners during use.
- It is not advisable to use earthenware or steatite pans to cook or heat food.

5.5 Using the griddle

A few precautions are necessary if you wish to use a griddle:

- leave a gap of at least 160 mm between the edge of the griddle and the side wall;
- if one of the burners close to the wooden rear wall is a triple crown burner, leave a gap of at least 160 mm between this wall and the edge of the griddle;
- do not allow the burner flames to extend beyond the edge of the griddle;
- operate the burners underneath the griddle for 10 minutes at maximum power, then turn them down to the minimum setting. Never use the griddle for more than 45 minutes.



6. CLEANING AND MAINTENANCE



Important: DO NOT USE STEAM JETS FOR CLEANING THE HOB.



Before performing any operations requiring access to powered parts, disconnect the appliance from the power supply.

6.1 Cleaning the hob



To keep the hob in good condition it should be cleaned regularly after use. Let it cool first.

6.1.1 Ordinary daily cleaning

To clean and preserve surfaces, always use **only** specific products that do not contain abrasives or chlorine-based acids.

How to use: pour the product onto a damp cloth and wipe the surface, rinse thoroughly and dry with a soft cloth or a microfibre cloth.

6.1.2 Food stains or residues

Do not use metallic sponges or sharp scrapers: they will damage the surface.

Use ordinary non-abrasive products, together with anti-scratch sponges and wooden or plastic utensils if necessary.

Rinse thoroughly and dry with a soft cloth or microfibre cloth.



6.2 Cleaning the components

6.2.1 Knobs

The knobs should be cleaned with lukewarm water and washing up liquid. For easier cleaning they can be removed by pulling them upwards. Dry thoroughly after cleaning.



Do not use aggressive products containing alcohol or products for cleaning steel and glass when cleaning the knobs, as these products could cause permanent damage.



6.2.2 Pan stands

Remove the pan stands and clean them with lukewarm water and non-abrasive detergent, making sure to remove any encrustations. Replace them on the cooking hob.

These components must not be washed in the dishwasher.



6.2.3 Flame-spreader crowns

For easier cleaning, the burner caps and flame-spreader crowns can be removed; wash them with warm water and non-abrasive detergent making sure to remove any encrustations and wait until they are **perfectly dry**.

The burner pins **A** must be inserted in the housings **B** in the burner crown. The holes **C** in the burner crowns should be slid over the igniters and thermocouples **D** on the hob.

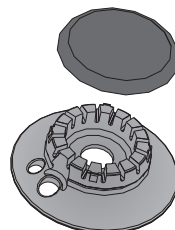

6.2.4 Igniters and thermocouples

For correct operation the igniters and thermocouples must always be perfectly clean. Check them frequently and clean them with a damp cloth if necessary. Remove any dry residues with a wooden toothpick or a needle.



After cleaning, dry the appliance thoroughly to prevent water or detergent drips from interfering with its operation or creating unsightly marks.



7. POSITIONING IN THE COUNTER TOP



The following operation requires building and/or carpentry work and must be carried out by a competent tradesman.

Installation can be carried out on various materials such as masonry, metal, solid wood or plastic laminated wood as long as they are heat resistant (T 90°C).



If installed on top of an oven, the latter must be equipped with a cooling fan.

7.1 Section cut from the work surface

Create an opening with the dimensions shown in the figure in the top surface of the counter.

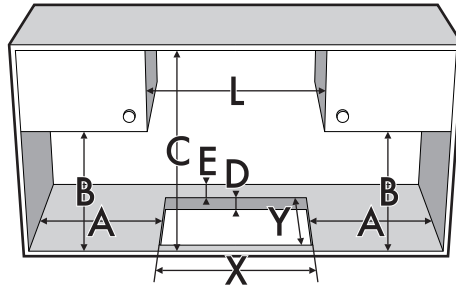

A (mm)	B (mm)	C (mm)	D (mm)	E (mm)	L (mm)	X (mm)	Y (mm)
min 150	min 460	min 750	20÷40	min 50	600-726	555÷560	478÷482

In case of installation on an empty kitchen unit with doors, a separation panel must be placed under the hob. Keep a minimum distance of **10 mm** between the bottom of the hob and the surface of the panel, which must be easily extractable to allow sufficient access for any technical assistance.

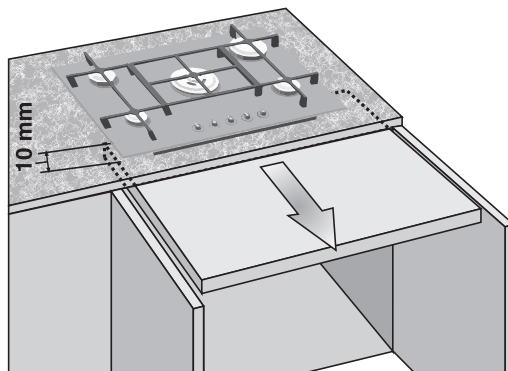

7.2 Placing the insulating seal

Carefully position the supplied insulating seal on the outer perimeter of the hole made in the counter top as shown in the figure below, trying to make it stick on the entire surface by applying light pressure on it with your hands (See the dimensions indicated in the figure). After having fastened the hob to the unit (See “7.3 Fixing using brackets”), carefully trim the surplus away from edge **C** beyond the seal. The dimensions given in the following drawing refer from the hole to **the inside** of the seal.

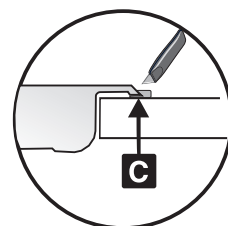
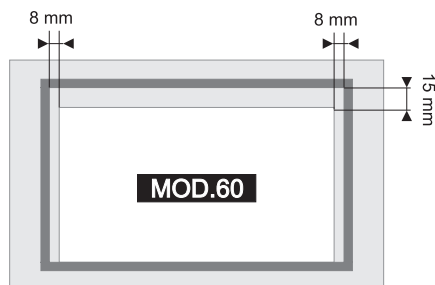
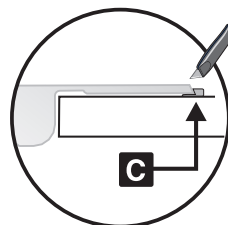
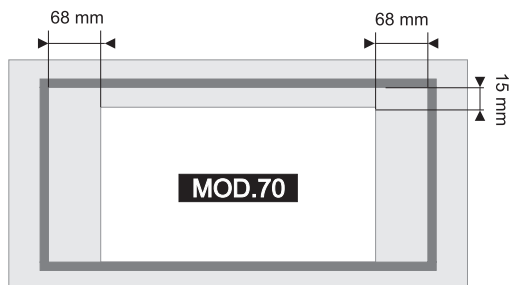



7.3 Fixing using brackets

The figure to the side shows the exact holes to be used to correctly attach the hob to the counter top with brackets.

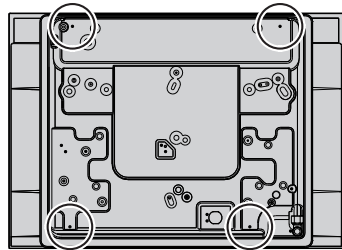
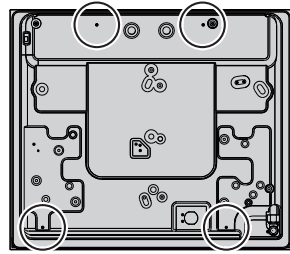

Fix the hob to the unit using the appropriate brackets supplied.

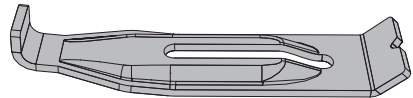

To secure the hob correctly to the counter top, tighten the brackets **A** in the appropriate holes on the sides of the casing.

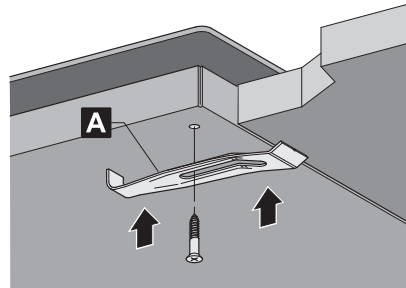

Take care while securing with the brackets; if tightened too much the glass may be strained causing it to crack.



8. ELECTRICAL CONNECTION



Make sure that the voltage and capacity of the power line conform to the data shown on the plate located under the casing.

Do not remove this plate for any reason.



The plug at the end of the supply cable and the wall socket must be of the same type and must conform to the applicable legislation on electrical installations. Make sure that the supply line is suitably earthed.



Pass the power supply cable through the back of the unit, taking care that it does not touch the bottom casing of the hob or the oven (if any) installed underneath it.



Fit the power supply line with a multipolar cut-out device with a contact opening gap equal to or greater than 3 mm in an easily accessible position close to the appliance.



Avoid use of adapters and shunts.



If the power cable is replaced, the cross-section of wires in the new cable must be no less than 1 mm² (3 x 1 mm² cable), remembering that the end to connect to the appliance must have an earth wire (yellow/green) which is at least 20 mm longer.

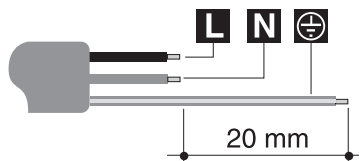

Only use a H05V2V2-F type cable or similar resistant to a maximum temperature of 90°C. The cable must be replaced by a specialised technician who must carry out the connection to the power grid following the diagram below.

L = brown

N = blue

 = yellow/green



The power supply cable must be replaced by an authorised service centre to prevent any risks.



The manufacturer declines all responsibility for damage to persons or things caused by non-observance of the above prescriptions or by interference with any part of the appliance.



9. GAS CONNECTION

If the appliance is installed on an oven, you must avoid running the gas tube round the back of the oven in order to avoid overheating.

Connection to the gas supply network can be made using a **rigid copper hose** or a continuous wall **flexible steel hose** in compliance with the guidelines established by the applicable standard.

To facilitate the connection, connector **A** on the back of the appliance can be orientated laterally; loosen hexagonal nut **B**, twist connector **A** into the required position then retighten hexagonal nut **B** (it is sealed with a rubber gasket). Once the operation is complete, check the hose fittings for leaks using a soapy solution; never use a flame.

The cooker hob is preset for **natural gas G20 (2H)** at a pressure of 20 mbar. For supplying it with other types of gas, see chapter "10. ADAPTATION TO DIFFERENT TYPES OF GAS". The gas inlet connection is threaded ½" for external gas (ISO 228-1).

Connection with a rigid copper hose: The connection to the gas supply network must be made in such a way that it does not cause stresses of any type on the appliance.

The connection can be made using the adapter unit **D** with double cone, always inserting gasket **C** (provided) in between.

Connection with a flexible steel hose: use only continuous wall stainless steel hoses that comply with the applicable standards, making sure to always insert gasket **C** (provided) between connector **A** and flexible hose **E**.

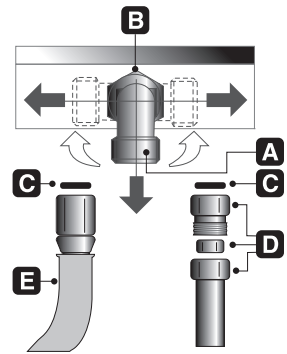

Installation with flexible hose must be carried out so that the length of the piping does not exceed 2 metres when fully extended; make sure that the hoses do not come into contact with moving parts and that they are not crushed in any way.



9.1 Connection to LPG



Use a pressure regulator and make the connection on the gas cylinder following the guidelines set out in the regulations in force.

Make sure that the feed pressure complies with the values indicated in the table at point “10. ADAPTATION TO DIFFERENT TYPES OF GAS”.

9.2 Room ventilation



The room containing the appliance should be permanently ventilated in accordance with the standards in force. The room where the appliance is installed must have enough air flow needed for the regular combustion of gas and the necessary air change in the room itself. The air vents, protected by grills, must be the right size to comply with current regulations and positioned so that no part of them is obstructed, not even partially.

The room must be kept adequately ventilated in order to eliminate the heat and humidity produced by cooking: in particular, after prolonged use, you are recommended to open a window or to increase the speed of any fans.

9.3 Extraction of the combustion products



The combustion products may be extracted by means of hoods connected to a natural draught chimney whose efficiency is certain or via forced extraction. An efficient extraction system requires precision planning by a specialist qualified in this area and must comply with the positions and distances indicated by the standards. When the job is complete, the installer must issue a certificate of conformity.



10. ADAPTATION TO DIFFERENT TYPES OF GAS



Before carrying out the following operations, disconnect the appliance from the power supply.

The cooker hob is preset for **natural gas G20 (2H)** at a pressure of 20 mbar. If other types of gas are to be used, the nozzles must be replaced and the primary air must be adjusted.

In order to replace the nozzles and adjust the burners, the hob top must be removed as described below.

10.1 Removing the hob top

- After having removed the pan stands, extract all knobs by lifting them upwards.

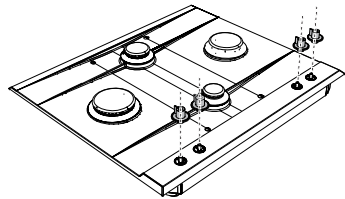

- Lift all the burner components off the hob.

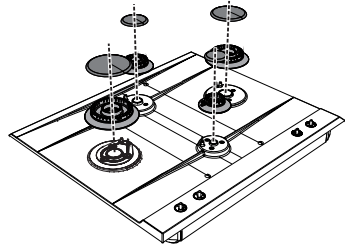

- Remove the screws fastening the top and the plates corresponding to each burner zone.

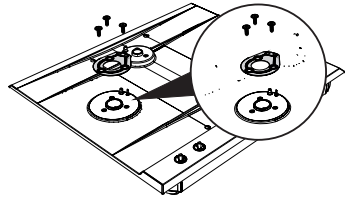

- For 70cm models only, the two back screws must also be removed.

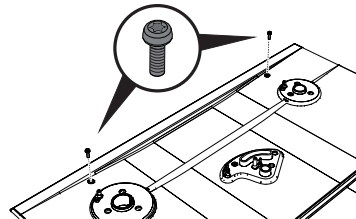



- Lift the hob top upwards.

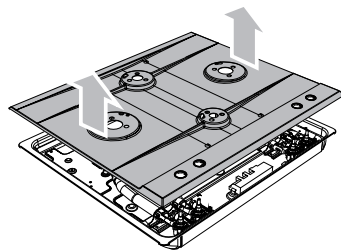

10.2 Adjustment for LPG

Loosen screw **A** and push support **B** all the way. Using a double head, remove nozzle **C** and replace it with the appropriate nozzle, following the instructions in the tables for the type of gas to be used. The nozzle tightening torque must be no more than 3 Nm. Reposition support **B** so that nozzle **C** is covered perfectly. Move the Venturi tube **D** to adjust the air flow until distance “X” is reached as indicated in the table in paragraph “10.4 Primary air adjustment” and then secure the tube by means of screw **A**. After the adjustments have been carried out, restore the seals with sealing wax or equivalent material.

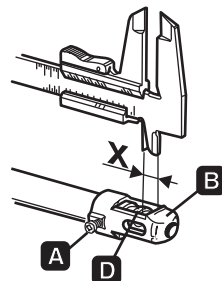
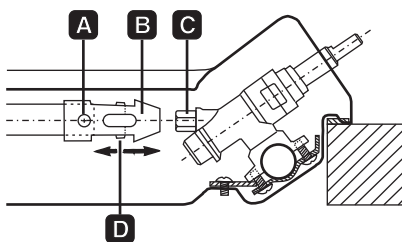

Burner	Rated heating capacity (kW)	LPG – G30/G31 28/37 mbar			
		Nozzle diameter 1/100 mm	Reduced capacity (W)	Capacity g/h G30	Capacity g/h G31
Auxiliary (1)	1.1	48	400	80	79
Semi-rapid (2)	1.7	62	500	124	121
Rapid (3)	3.1	85	1000	225	221
Reduced Rapid (4)	2.6	76	750	189	186
Ultra-rapid (5)	3.5	87	1600	254	250
Double crown	Internal (6)	48	400	73	71
	External (6)	85	1400	233	229



10.3 Adjustment for natural gas

The hob is preset for natural gas G20 (2H) at a pressure of 20 mbar. To reset the appliance for operation with this type of gas, carry out the same steps as described in "10.2 Adjustment for LPG", but select the nozzles and adjust the primary air for natural gas as indicated in the table below and in "10.4 Primary air adjustment". After the adjustments have been carried out, restore the seals with sealing wax or equivalent material.

Burner		Rated heating capacity (kW)	Natural gas – G20 20 mbar	
			Nozzle diameter 1/100 mm	Reduced capacity (W)
Auxiliary (1)		1.1	76	400
Semi-rapid (2)		1.7	95	500
Rapid (3)		3.1	126	900
Reduced Rapid (4)		2.6	115	750
Ultra-rapid (5)		3.5	135	1600
Double crown	Internal (6)	1.0	73	400
	External (6)	3.2	130	1400



10.4 Primary air adjustment

Refers to distance "X" in mm.

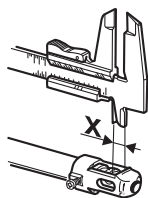

BURNER		G30/G31 30/37 mbar	G20 20 mbar
Auxiliary (1)		1.5	1
Semi-rapid (2)		1.5	0.5
Rapid (3)		8	1
Reduced Rapid (4)		1.5	1
Ultra-rapid (5)		3	1.5
Double crown (6)	Internal	4	2
	External	8	1

To identify the burners on your hob, refer to the drawings in "10.6 Arrangement of the burners on the cooking hob".

10.5 Final operations

After making the adjustments described above, reassemble the appliance by following the instructions in "10.1 Removing the hob top" in reverse order.

10.5.1 Adjusting the minimum setting for city and natural gas

Reposition the components on the burner and slide the knobs onto the tap rods.

Light the burner and set it on the minimum position. Extract the knob again and turn the adjustment screw inside or next to the tap rod (depending on the model) until the correct minimum flame is achieved.

Refit the knob and verify that the burner flame is stable (when turning the knob rapidly from the maximum to the minimum position the flame must not go out).

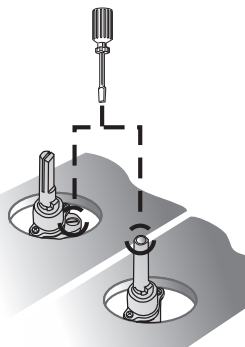

10.5.2 Adjusting the minimum setting for LPG

To adjust the minimum setting with LPG, you must tighten the screw inside or next to the tap rod (depending on the model) fully in a clockwise direction.

The bypass diameters for each individual burner are shown in table "10.2 Adjustment for LPG".

After adjustment with a gas other than the preset one, replace the label on the casing of the appliance with the label corresponding to the new gas. The label is inserted inside the pack together with the nozzles.





10.6 Arrangement of the burners on the cooking hob

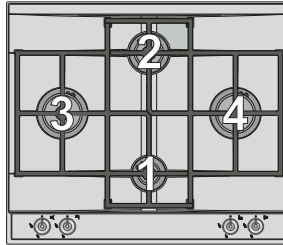
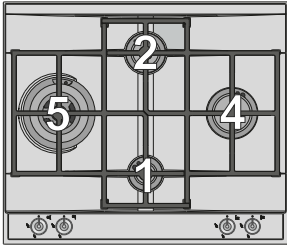

BURNERS

1. Auxiliary
2. Semi-rapid
3. Rapid
4. Reduced Rapid
5. Ultra-rapid
6. Double crown

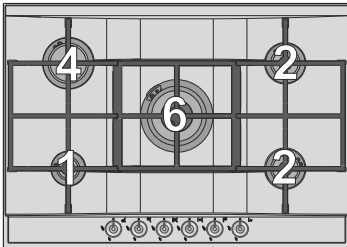

10.7 Lubrication of gas taps



Over time the gas taps may become difficult to turn and get blocked. Clean them internally and replace the lubrication grease.

This procedure must be carried out by a specialised technician.