

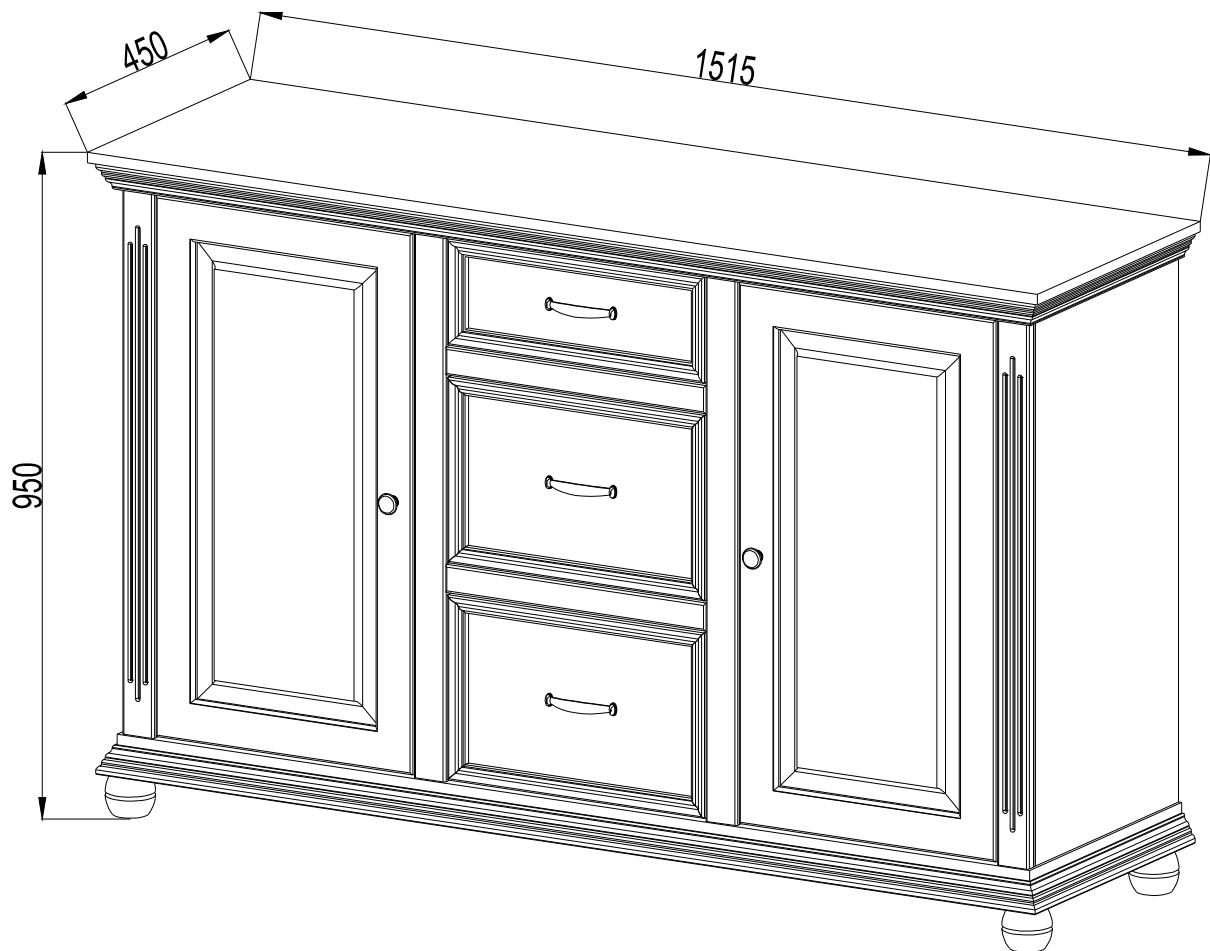

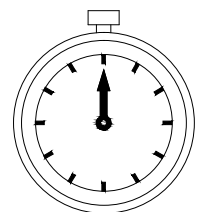

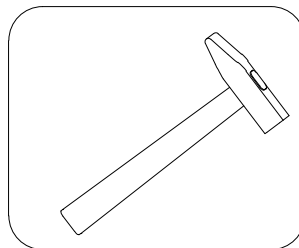

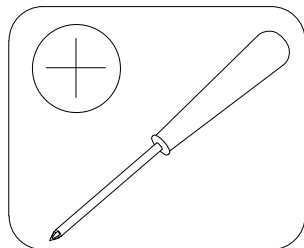

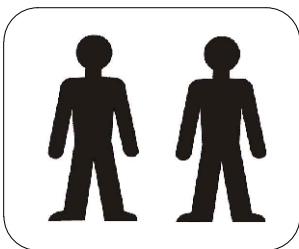













# Elena





Art . 23590008/04

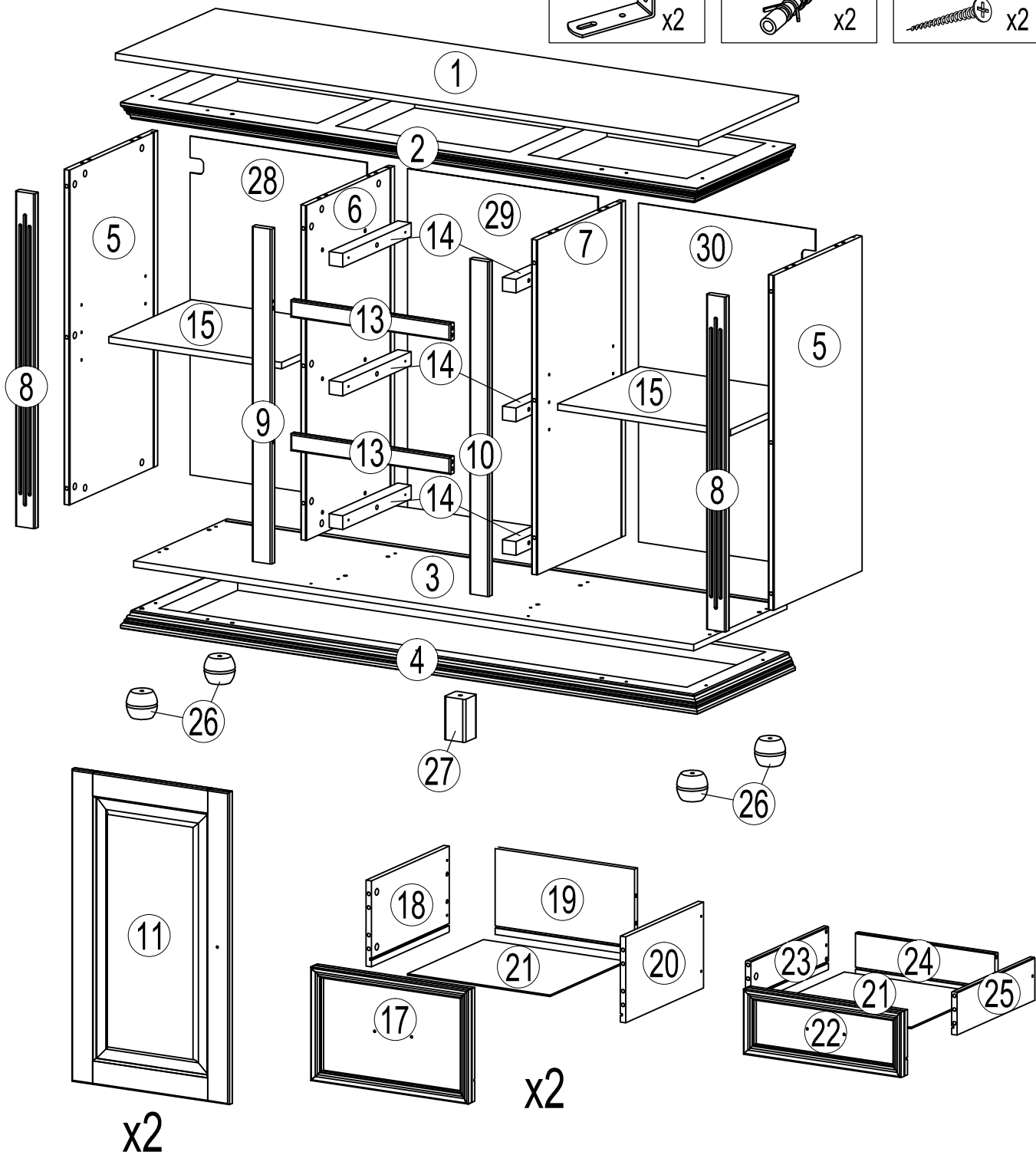

90 min

- |  |  |   |   |  |  |   |
|--|--|---|---|--|--|---|
| <b>A</b><br> x42          | <b>B</b><br> x42          | <b>C</b><br>8x32<br> x65 | <b>Da</b><br>    | <b>Db</b><br> x6          | <b>E</b><br>Ø3.5x35<br> x30 | <b>F</b><br>3.5x15<br> x48 |
| <b>G1</b><br>M4x22<br> x2 | <b>G2</b><br>M4x20<br> x6 | <b>H</b><br> x2          | <b>J</b><br> x3  | <b>K</b><br> x8         | <b>L</b><br> x4             |   |
| <b>M</b><br> x12          | <b>Na</b><br> x3          | <b>Nb</b><br> x3         | <b>Nc</b><br> x3 | <b>Nd</b><br> x3        | <b>P</b><br> x1             |   |
|  |  |   | <b>Q</b><br> x2  | <b>R</b><br>8x50<br> x2 | <b>S</b><br>5x50<br> x2     |   |



| №  | B/H/T, mm   | Q | №<br> | ✓ | №  | B/H/T, mm  | Q | №<br> | ✓ |
|----|-------------|---|--|---|----|------------|---|--|---|
| 1  | 1515x450x15 | 1 | 1/2  |   | 16 |            |   |  |   |
| 2  | 1498x442x40 | 1 | 1/2  |   | 17 | 409x265x33 | 2 | 1/2  |   |
| 3  | 1455x420x15 | 1 | 1/2  |   | 18 | 350x200x14 | 2 | 1/2  |   |
| 4  | 1498x442x40 | 1 | 1/2  |   | 19 | 362x200x14 | 2 | 1/2  |   |
| 5  | 780x397x15  | 2 | 2/2  |   | 20 | 350x200x14 | 2 | 1/2  |   |
| 6  | 780x397x15  | 1 | 2/2  |   | 21 | 371x342x3  | 3 | 1/2  |   |
| 7  | 780x397x15  | 1 | 2/2  |   | 22 | 409x152x33 | 1 | 1/2  |   |
| 8  | 780x50x18   | 2 | 2/2  |   | 23 | 350x100x14 | 1 | 1/2  |   |
| 9  | 780x50x18   | 1 | 2/2  |   | 24 | 362x100x14 | 1 | 1/2  |   |
| 10 | 780x50x18   | 1 | 2/2  |   | 25 | 350x100x14 | 1 | 1/2  |   |
| 11 | 774x409x18  | 2 | 1/2  |   | 26 | 60x70x70   | 4 | 1/2  |   |
| 12 |             |   |  |   | 27 | 100x54x54  | 1 | 1/2  |   |
| 13 | 415x40x18   | 2 | 1/2  |   | 28 | 789x459x3  | 1 | 2/2  |   |
| 14 | 308x35x32   | 6 | 1/2  |   | 29 | 789x494x3  | 1 | 2/2  |   |
| 15 | 449x372x15  | 2 | 1/2  |   | 30 | 789x459x3  | 1 | 2/2  |   |

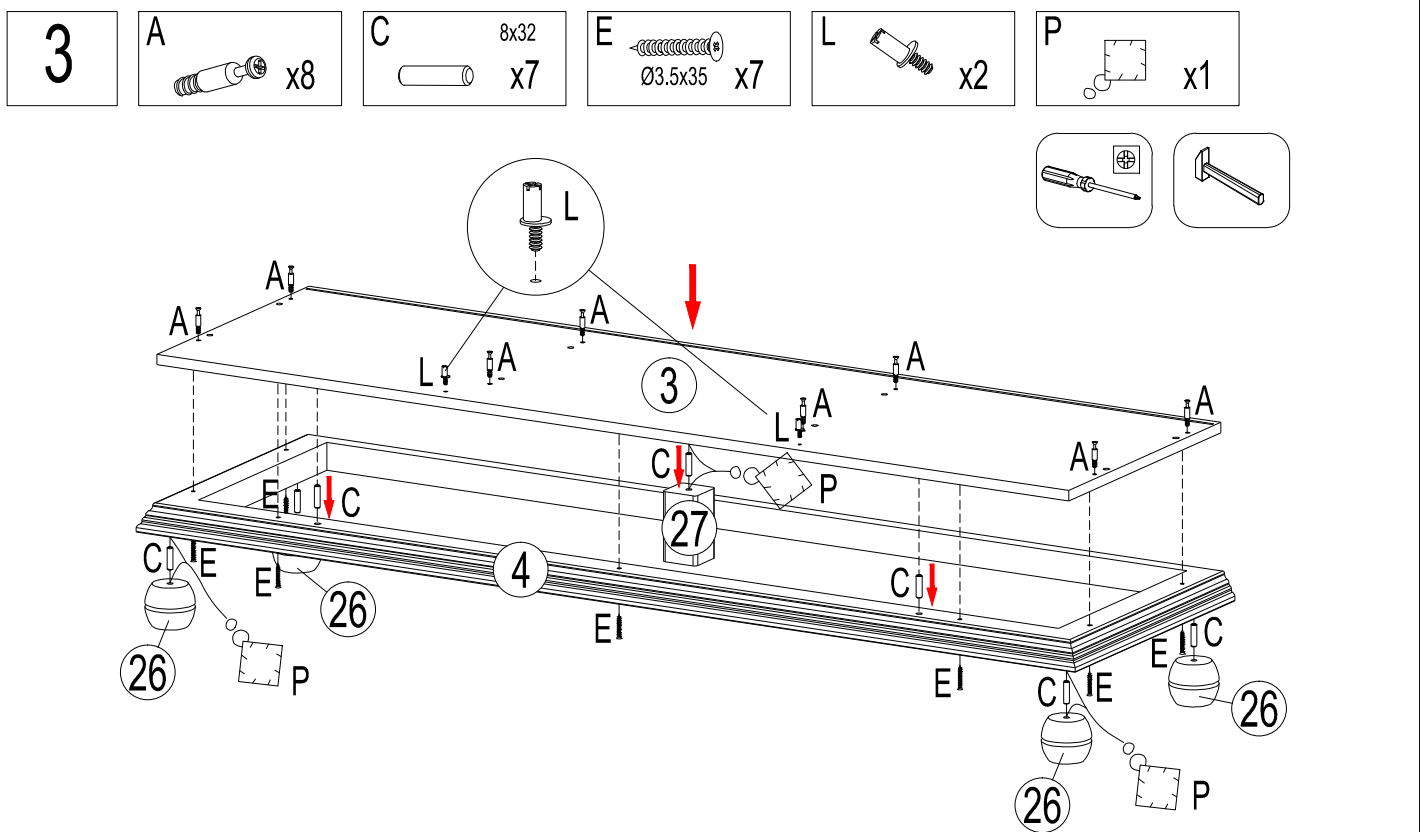
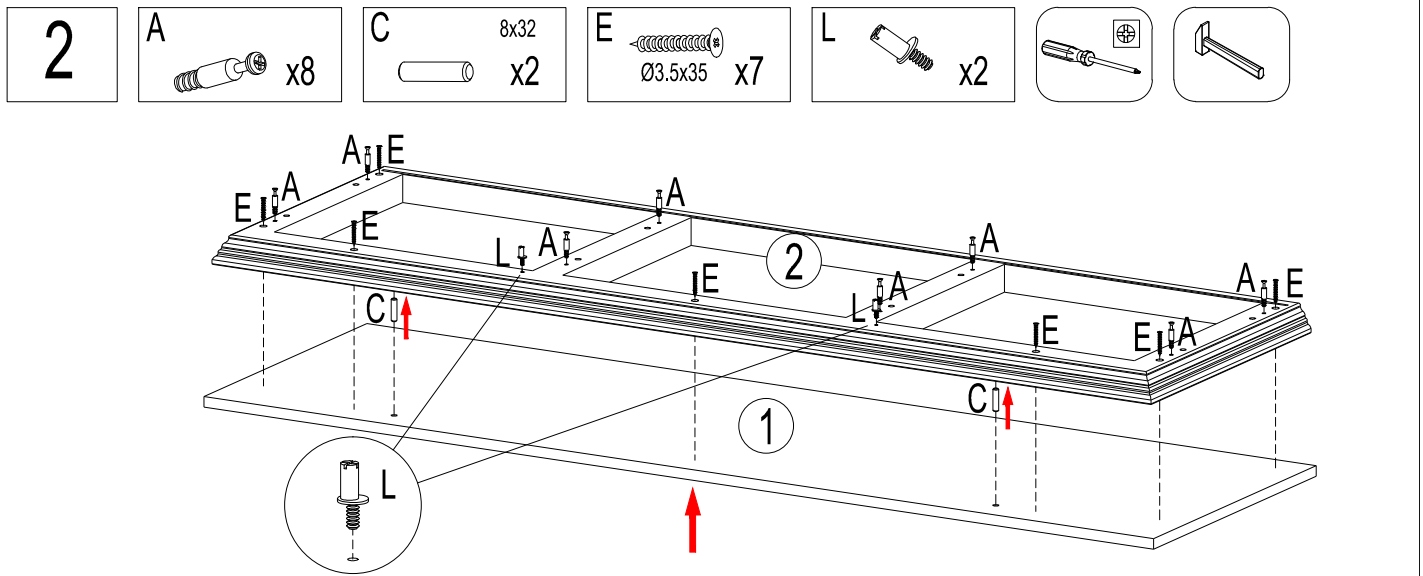
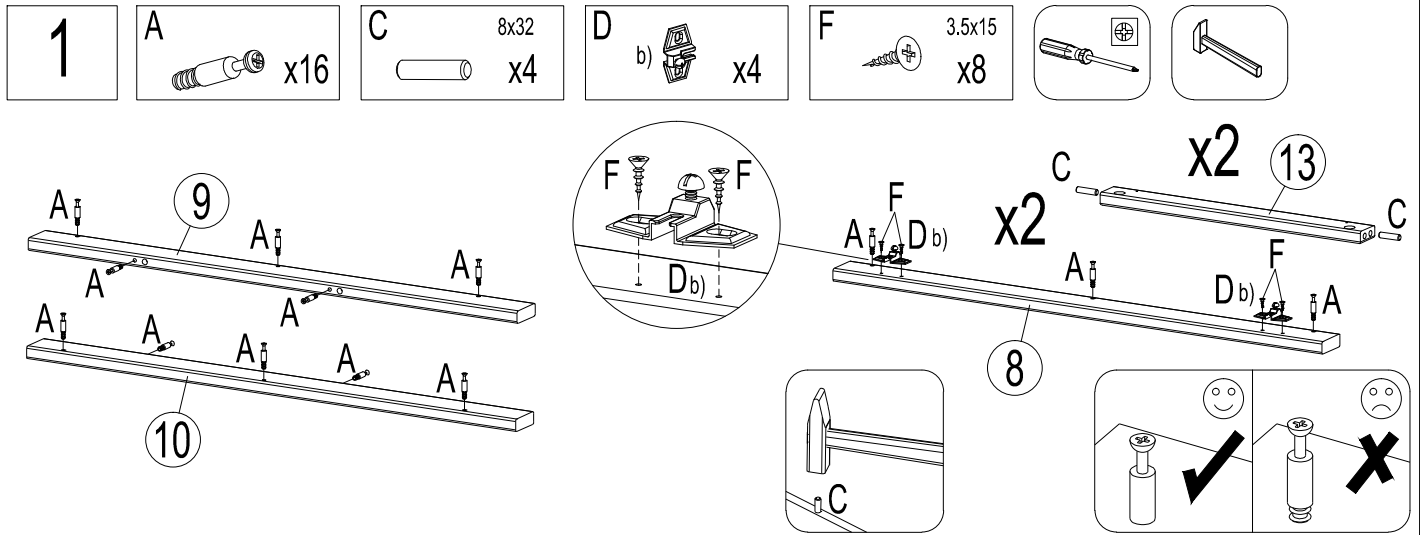

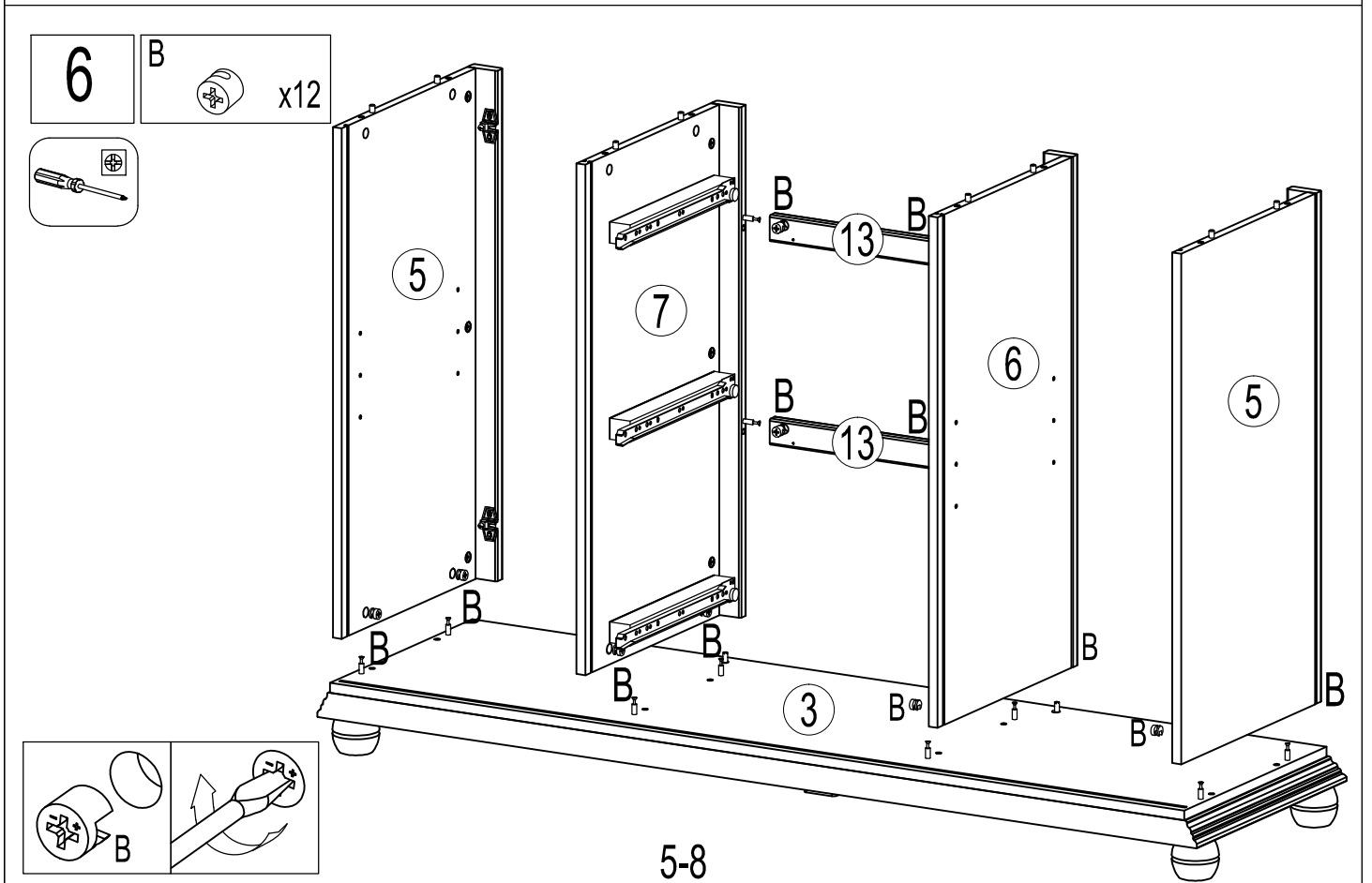
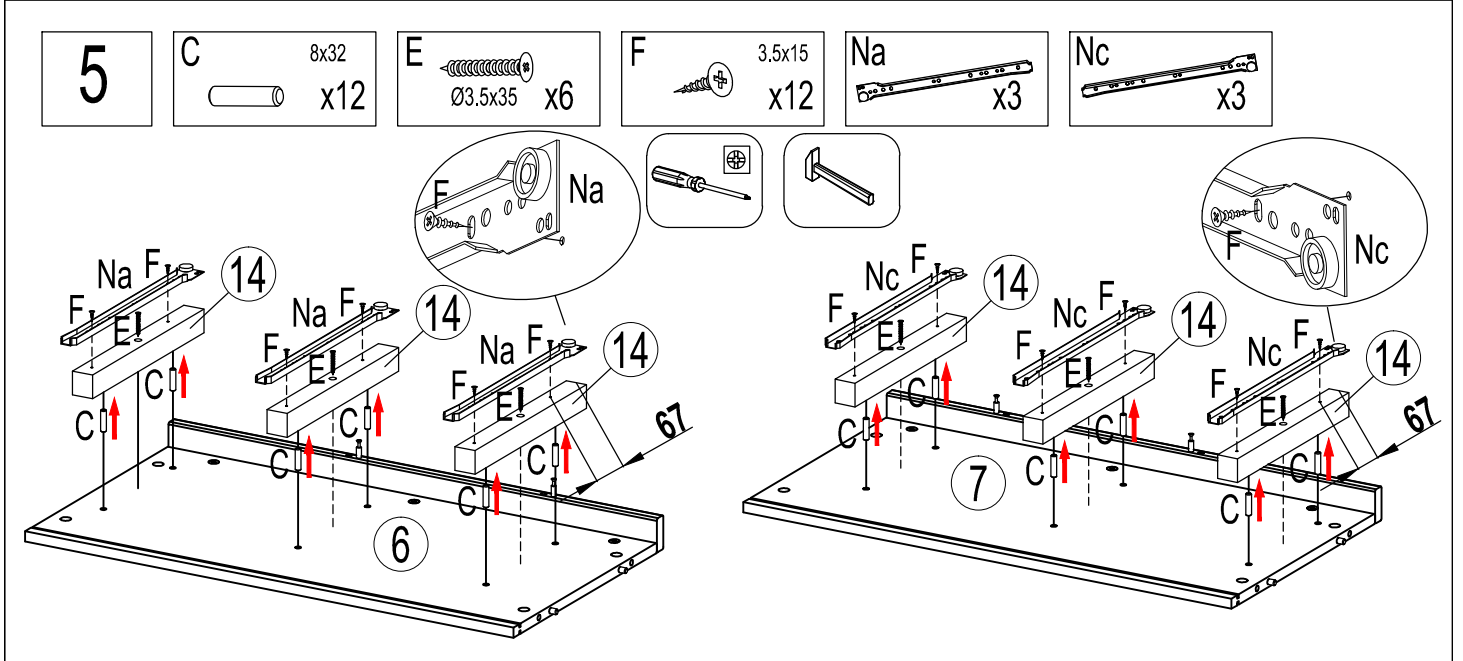
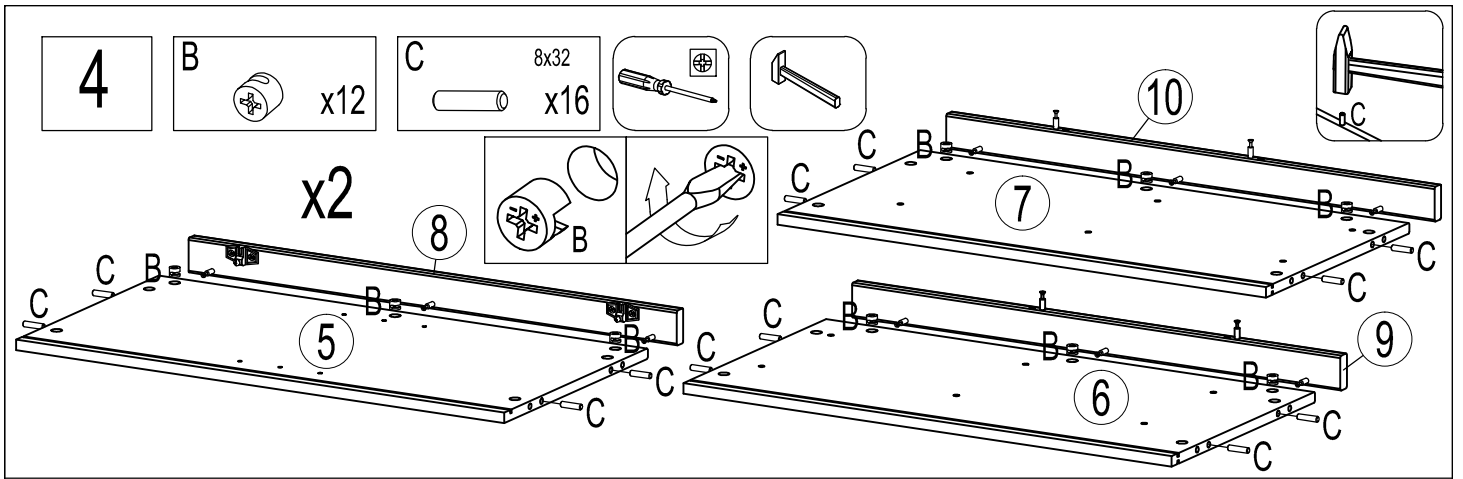

7

B  x8

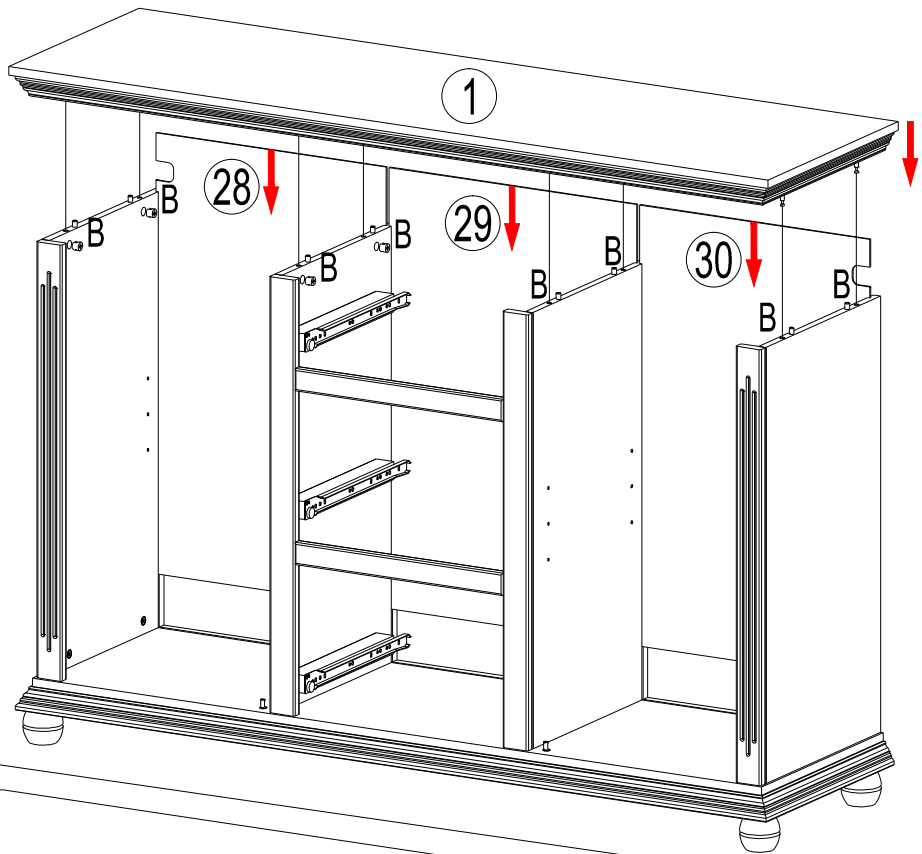
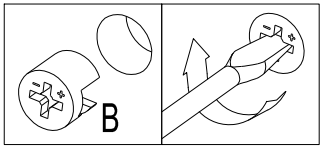
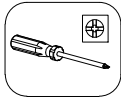

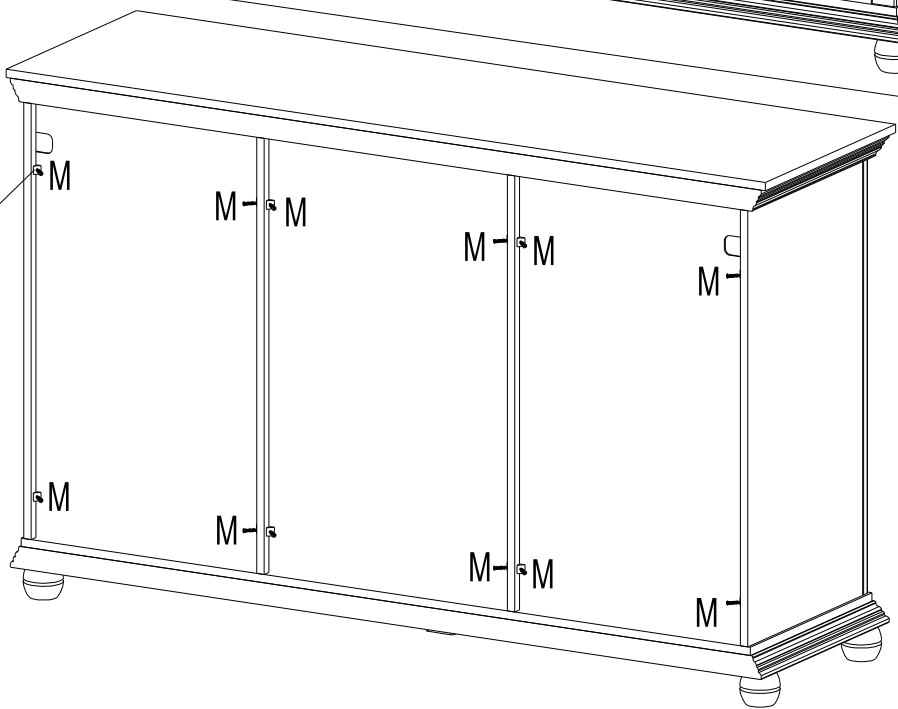
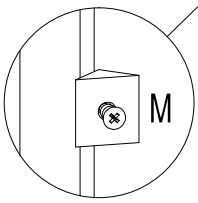

8

M  x12



9

D  a) x4







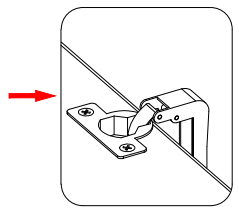
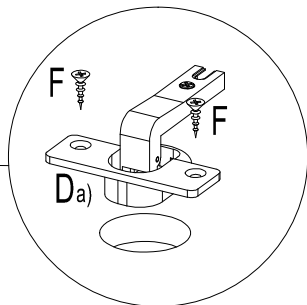
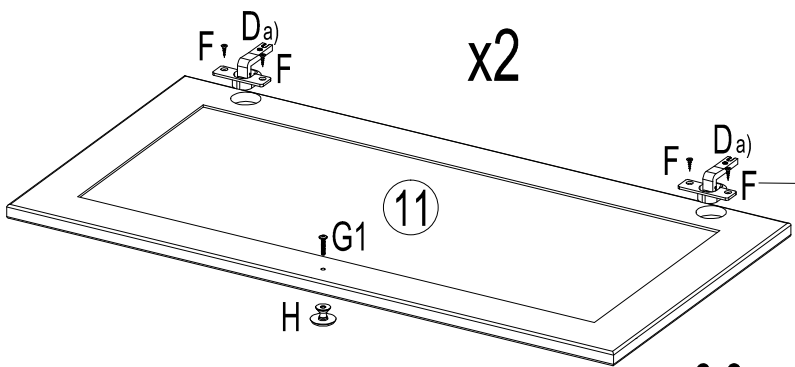
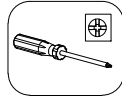



F  3.5x15 x8

G1  M4x22 x2

H  x2

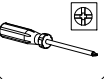
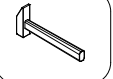

6-8

- |   |  |  |   |  |   |  |
|---|--|--|---|--|---|--|
| <b>10</b>   | <b>A</b>  x10 | <b>B</b>  x10 | <b>C</b>  8x32 x24 | <b>E</b>  Ø3.5x35 x10 | <b>F</b>  3.5x15 x12 | <b>G2</b>  M4x20 x6 |
|  |               | <b>J</b>  x3  | <b>Nb</b>  x3      | <b>Nd</b>  x3        |   |  |

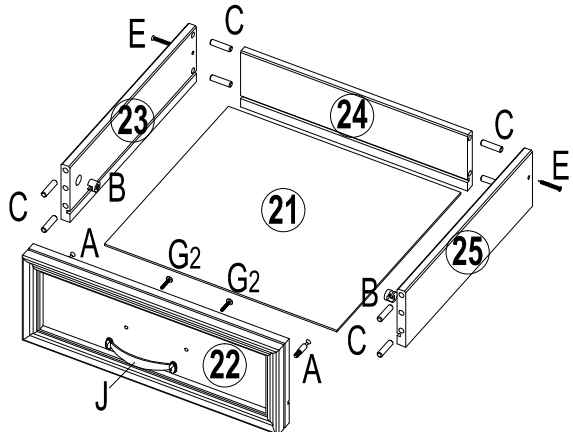

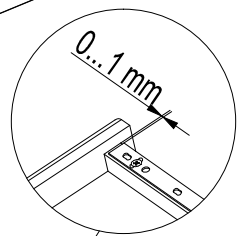
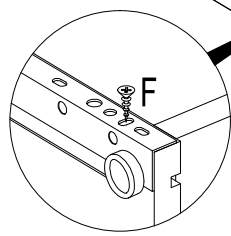
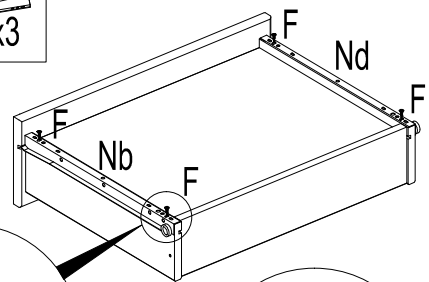

x1

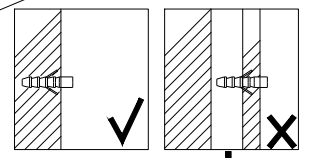
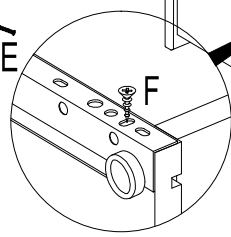
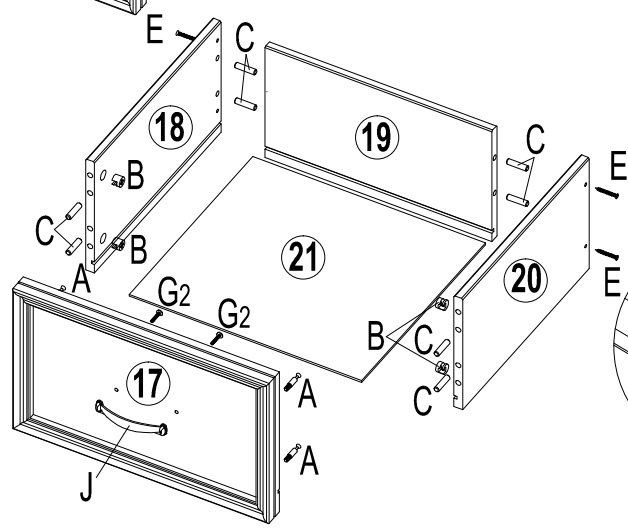

x2

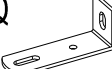

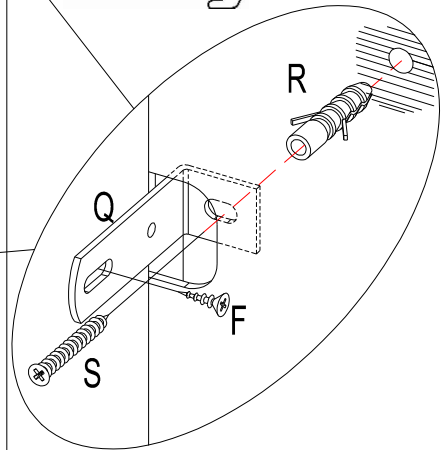
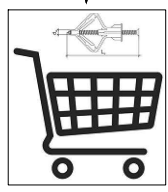
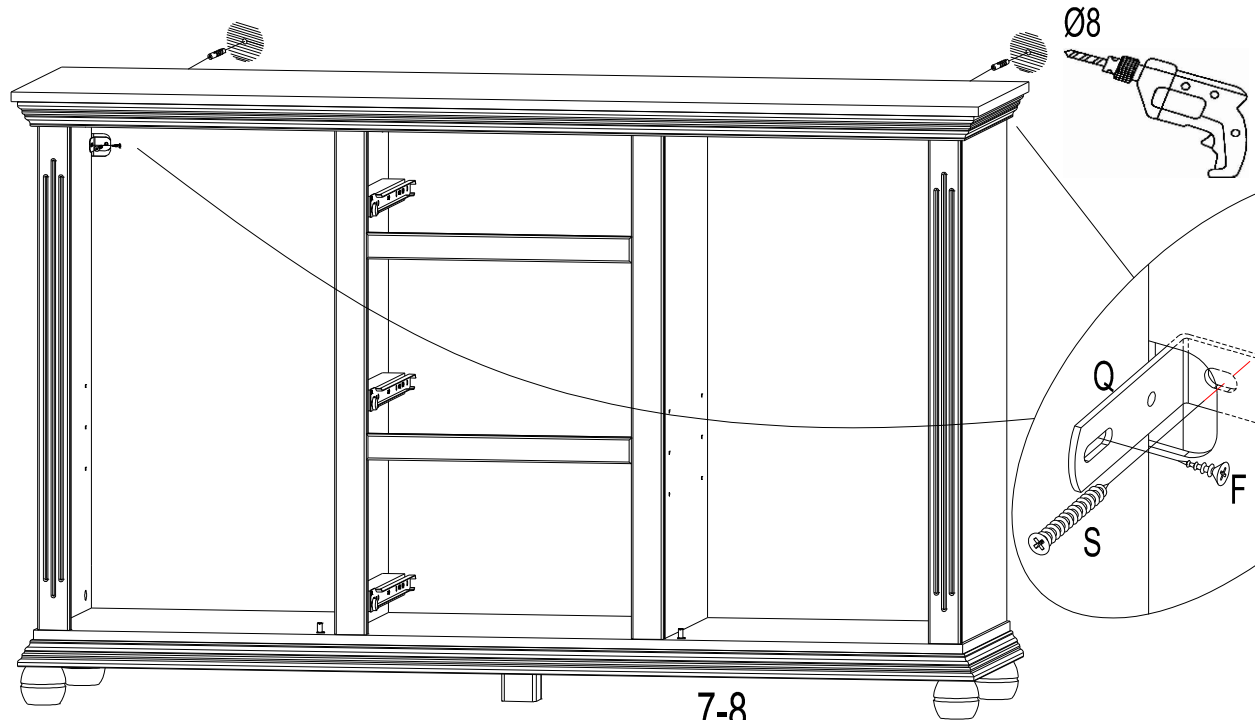

- |           |  |   |  |   |
|-----------|--|---|--|---|
| <b>11</b> | <b>F</b>  3.5x15 x2 | <b>Q</b>  x2 | <b>R</b>  8x50 x2 | <b>S</b>  5x50 x2 |
|-----------|--|---|--|---|



7-8

12

K  x8

F  3.5x15  
x6

