



# SONIC™

THE HEDGEHOG

77005



Q LEGO® Builder



### **Get excited about our new packaging!**

We're switching from plastic to paper-based packaging. That's why you might find a mix of paper and plastic in our boxes!

### **Nos nouveaux emballages vous emballeront !**

Nous passons des emballages en plastique aux emballages à base de papier. C'est pourquoi vous pourriez trouver un mélange de papier et de plastique dans nos boîtes !

### **¡Te presentamos nuestros nuevos empaques!**

Estamos sustituyendo las bolsas de plástico por bolsas con base de papel. ¡Por eso, puedes encontrar una mezcla de papel y de plástico en nuestras cajas!

**[LEGO.com/sustainable-packaging](https://www.lego.com/sustainable-packaging)**

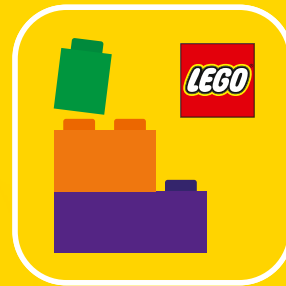

🔍 LEGO® Builder

# BUILDER



Apple and the Apple logo are trademarks of Apple Inc., registered in the U.S. and other countries and regions. App Store is a service mark of Apple Inc. Google Play and the Google Play logo are trademarks of Google LLC. Tencent and the Tencent logo are trademarks of Tencent Inc.

🔍 [LEGO.com/devicecheck](https://www.lego.com/devicecheck)

**EN** Ask parents' permission before going online | **DE** Eltern um Erlaubnis bitten, bevor du online gehst | **FR** Demande l'autorisation d'un parent avant d'aller en ligne | **IT** Chiedi il permesso ai tuoi genitori prima di andare online | **ES** Pídeles permiso a tus papás antes de conectarte a Internet | **PT** Peça autorização aos pais antes de acederes online | **ZH** 上网前应先征得父母的同意 | **PL** Poproś rodziców o zgodę, zanim wejdziesz do Internetu | **CS** Než půjdeš na internet, požádej rodiče o svolení | **SK** Skôr než pôjdeš na internet, vypýtaj si povolenie od rodičov | **HU** Kérj szülői engedélyt, mielőtt online csatlakoznál! | **UA** Запитуйте дозволу батьків, перш ніж користуватися інтернетом | **RO** Cere permisiunea părinților înainte de a te conecta online | **BG** Поискайте разрешение от родител, преди да влезете онлайн | **LV** Pirms došanās tiešsaistē palūdz atļauju vecākiem | **ET** Enne Interneti kasutamist küsi vanematelt luba | **LT** Prieš prisijungdami prie interneto, atsiklauskite tėvų

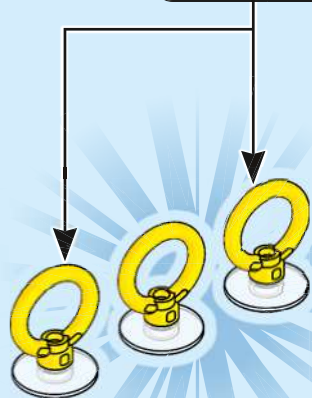
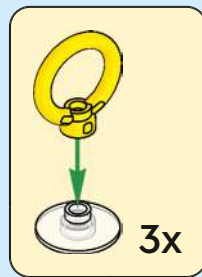
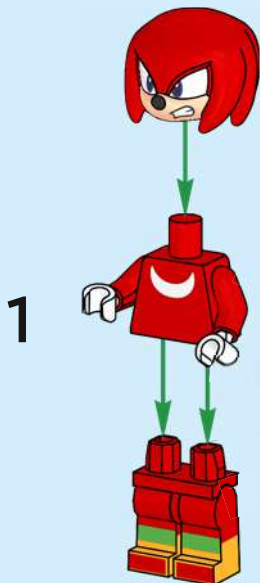

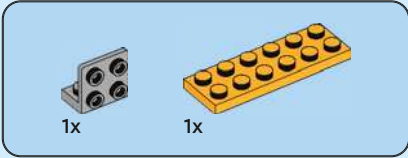
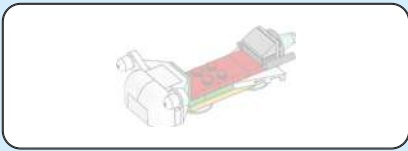

1

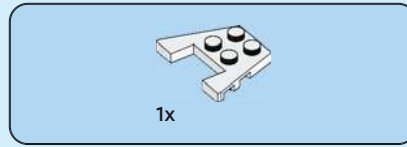
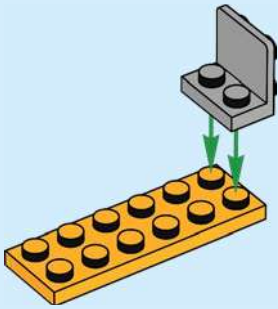

2



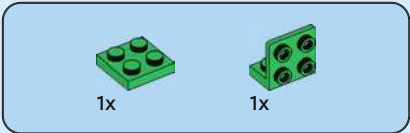

3

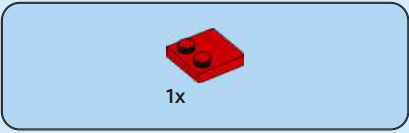
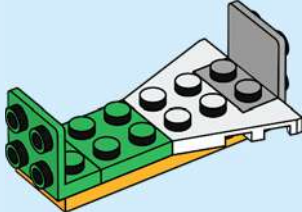

4

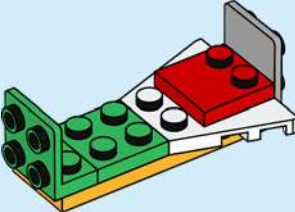



5

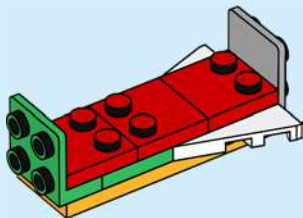

6

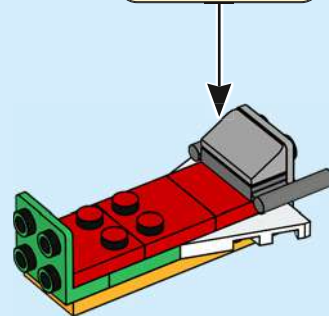
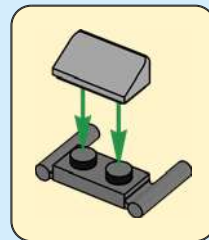



1x



1x

7

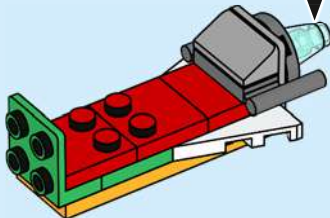

2x

8

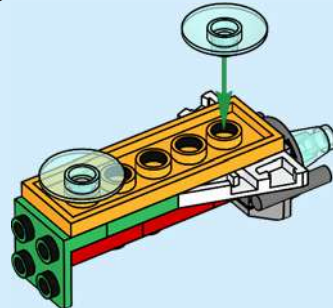

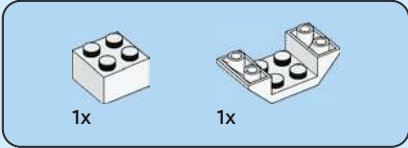

9

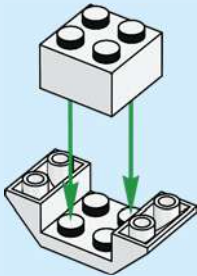

10

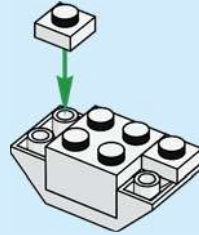

11

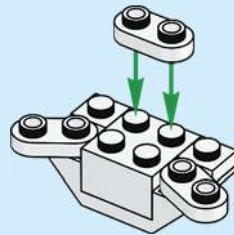

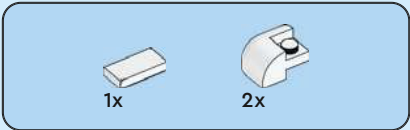

12

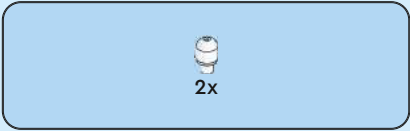
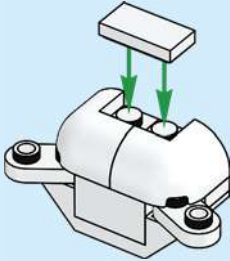

13



14

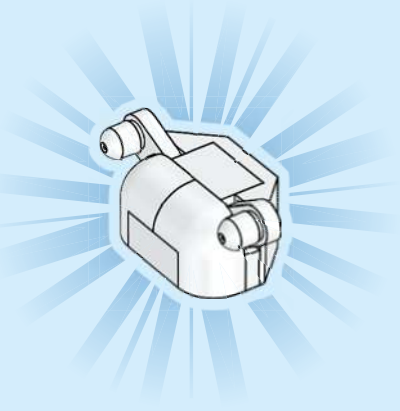

15

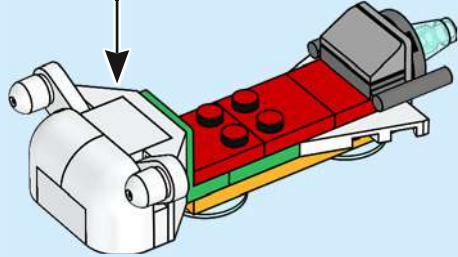

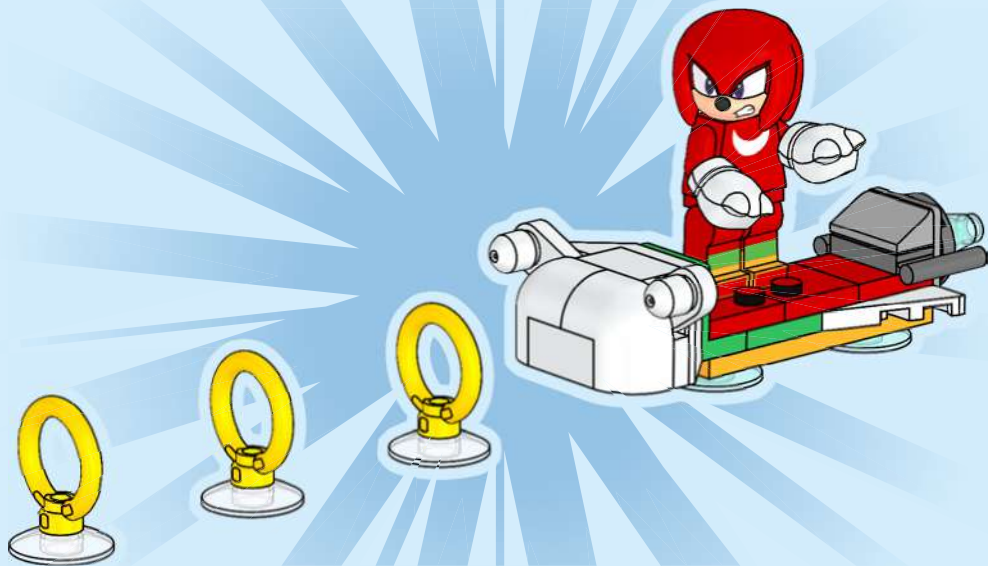

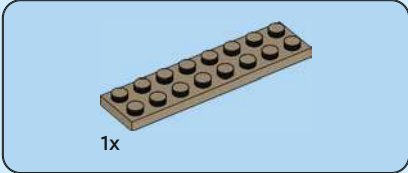
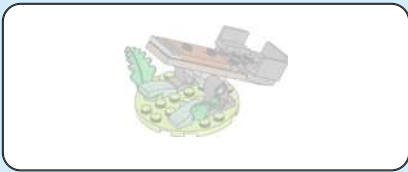

1

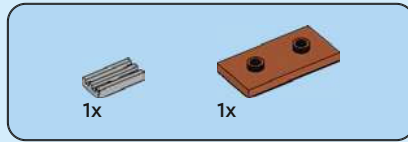
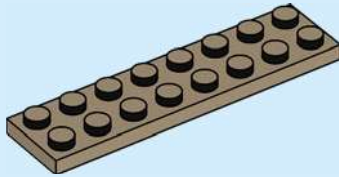

2

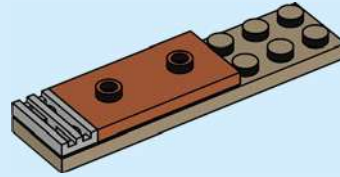

3

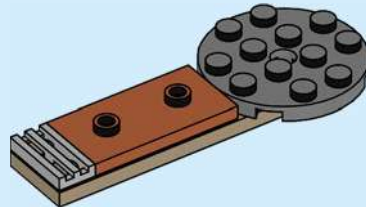



4

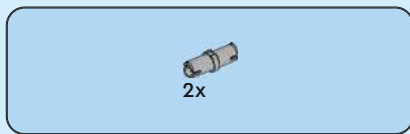
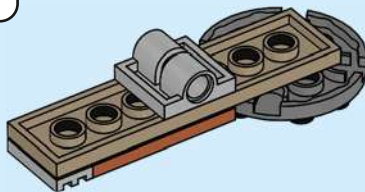

5

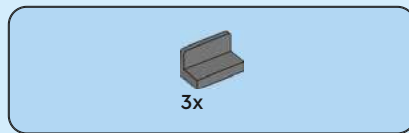
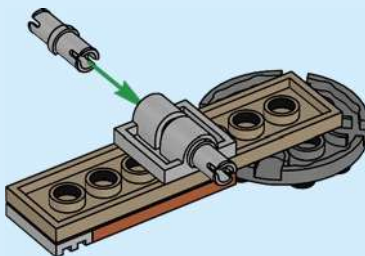

6

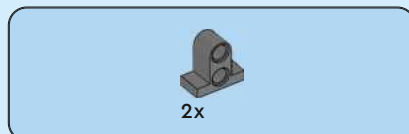
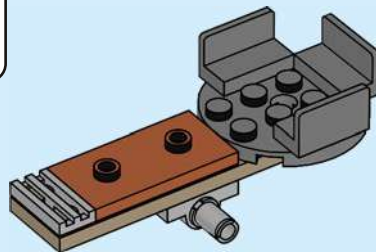

7

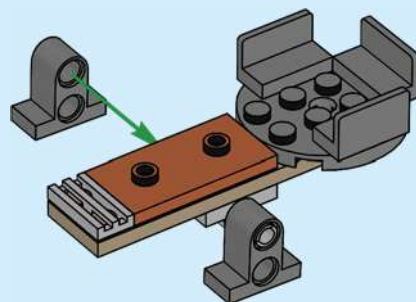

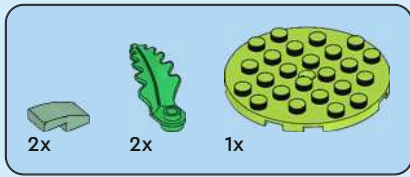

8

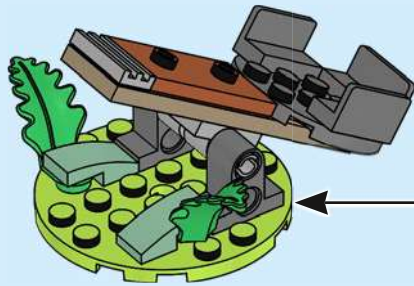
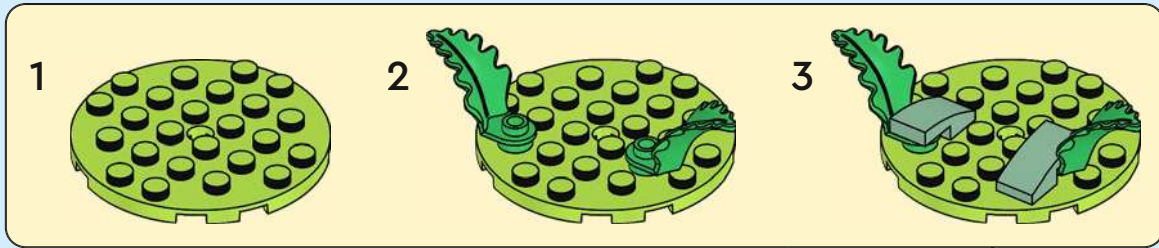

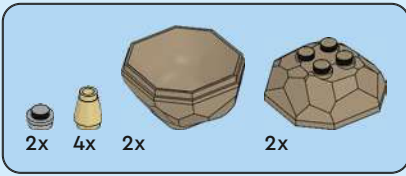

9

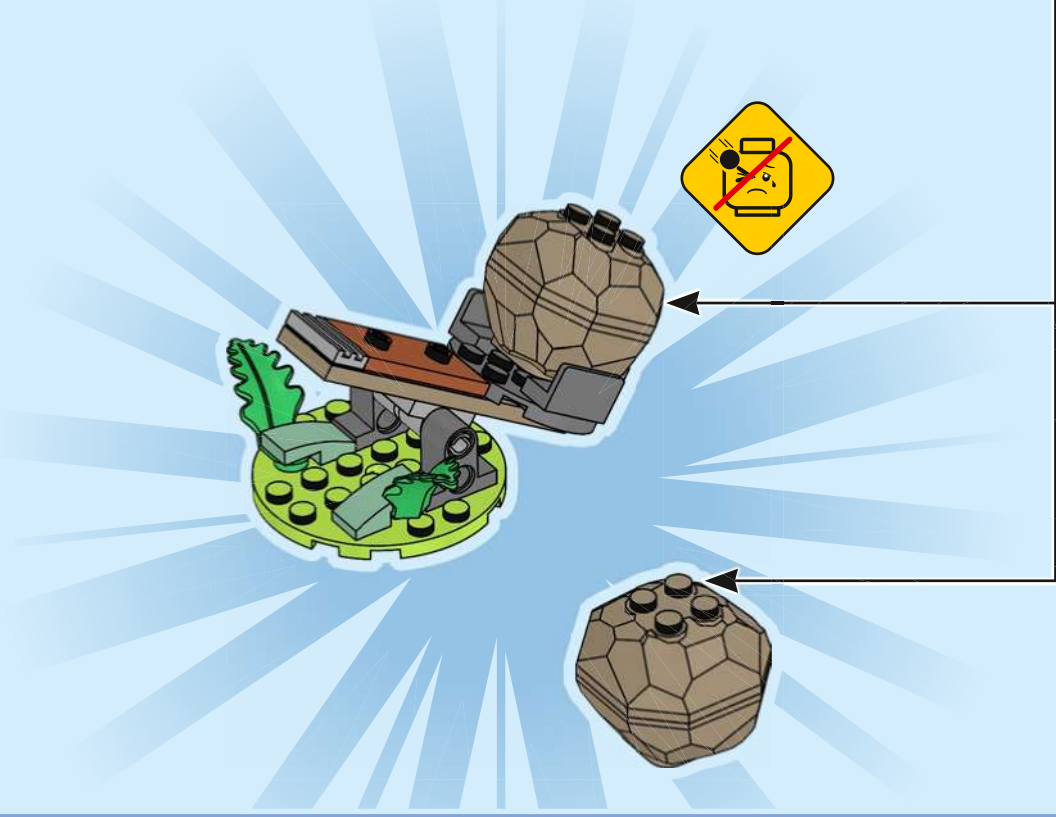
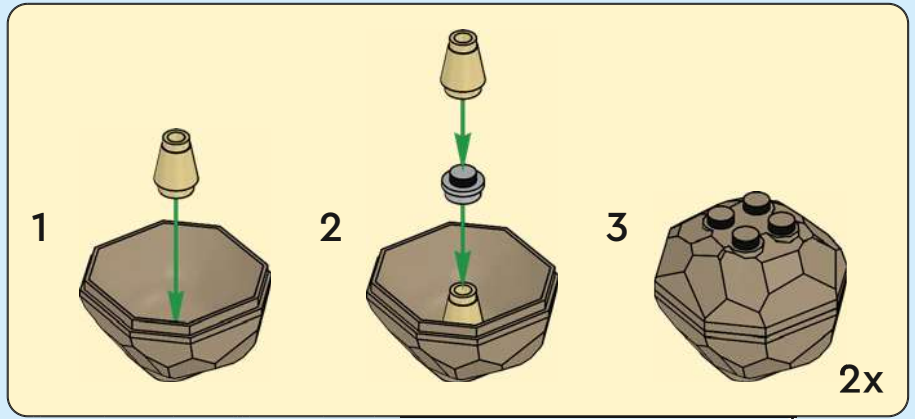

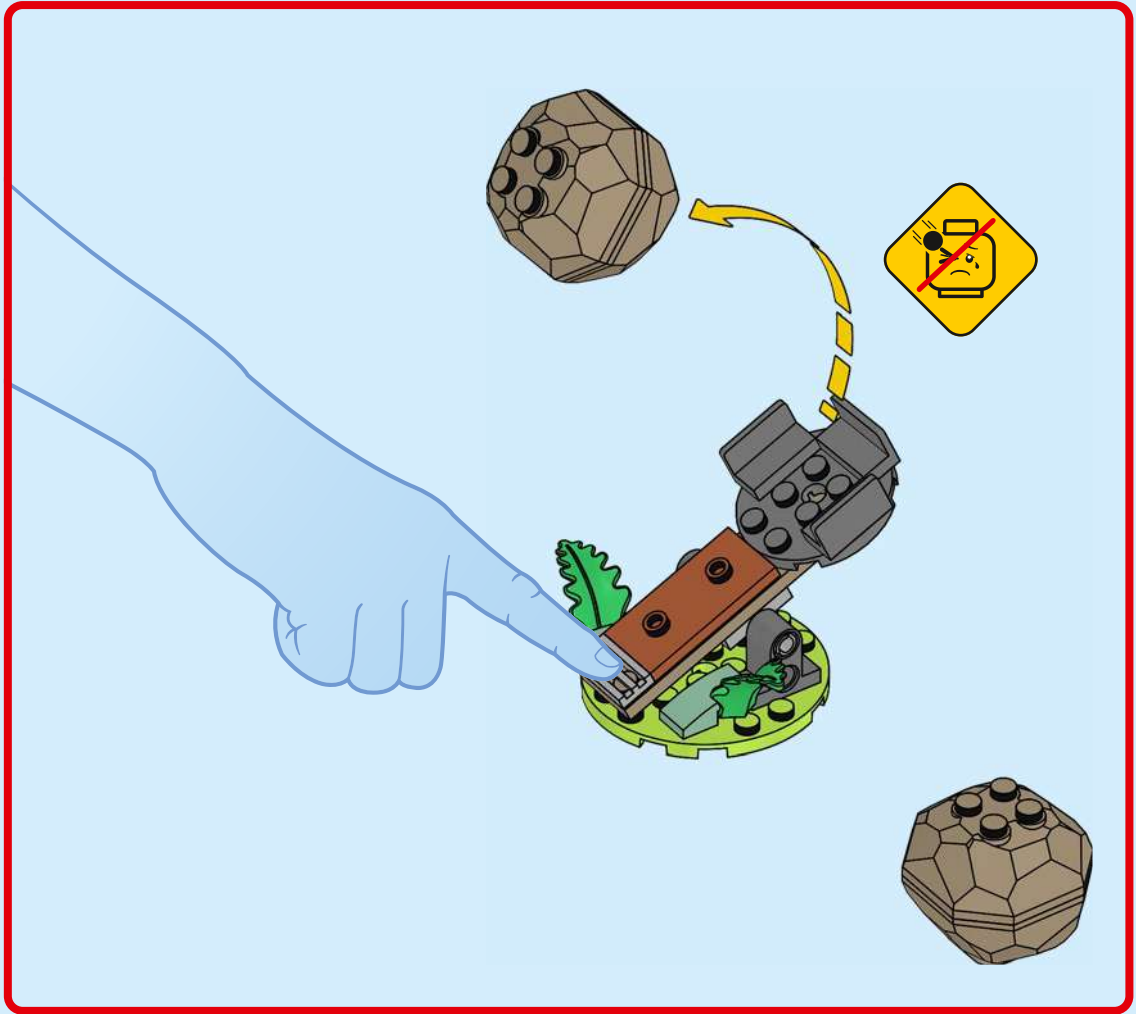

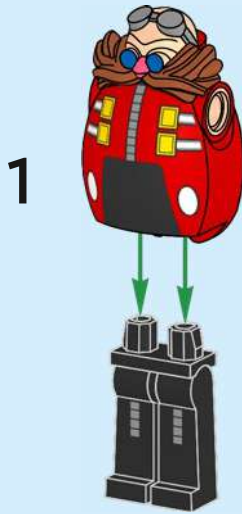

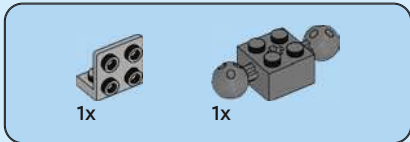

1

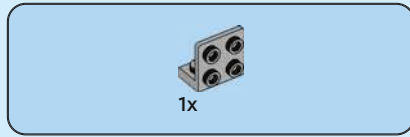
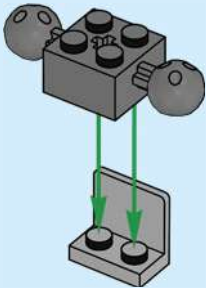

2

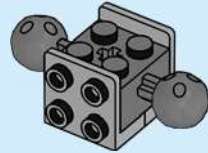

3

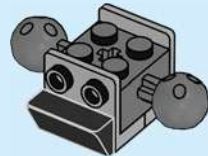

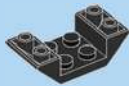

1x

4

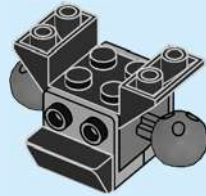

2x



2x

5

1



2



3

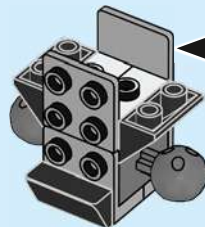



2x



4x



2x



2x

6

1

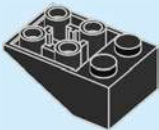

2



3

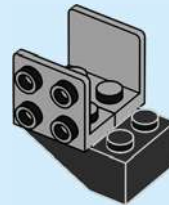

4

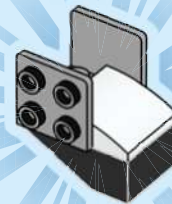

2x



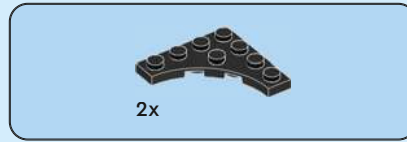
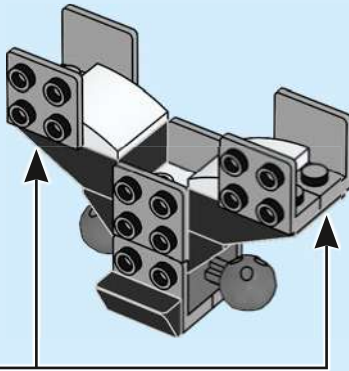

7

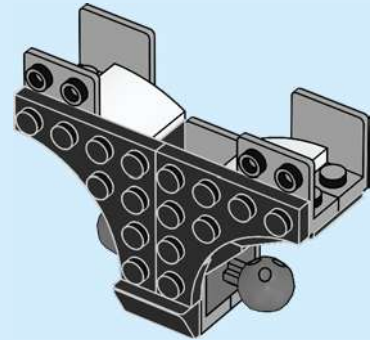



2x



2x



2x



2x



4x



4x



2x



2x

8

1



2



3

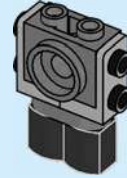

4



5



6



2x

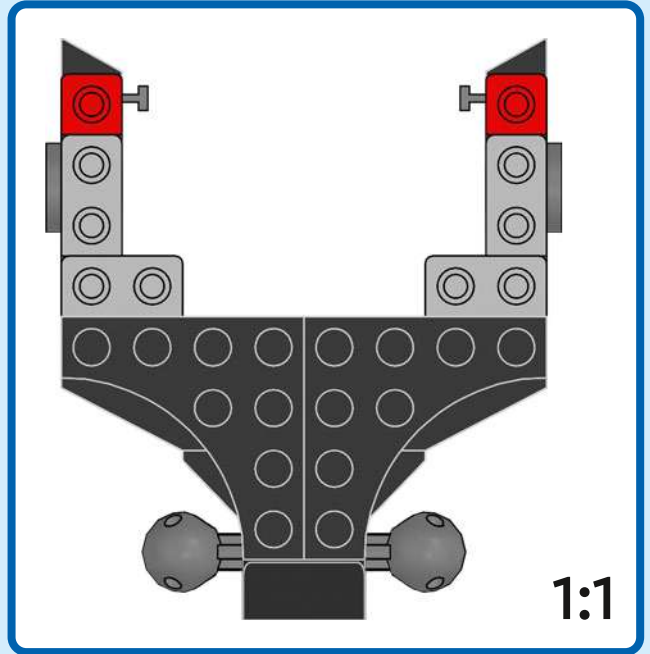
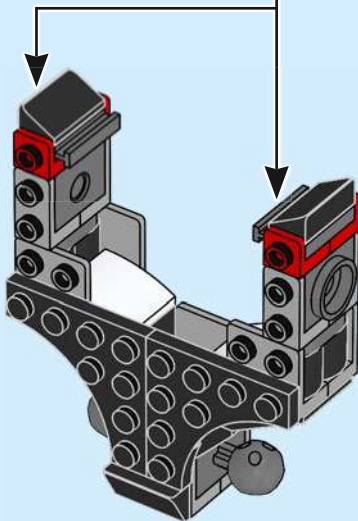

1:1



2x

9

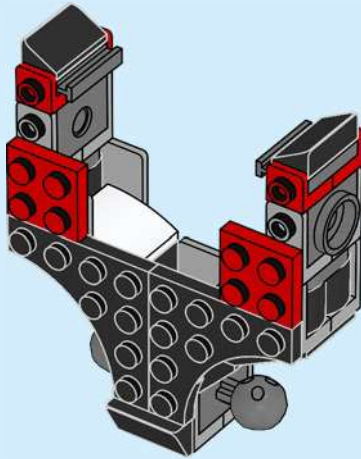

1x

10

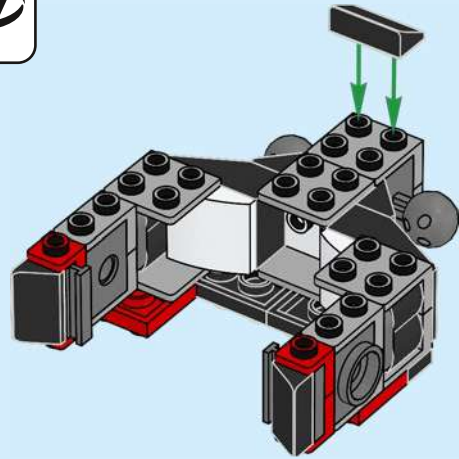

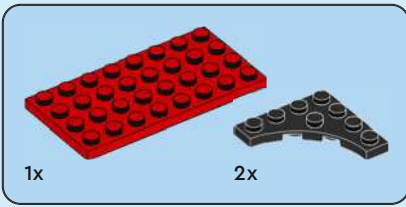

11

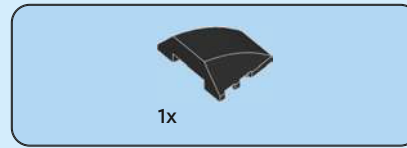
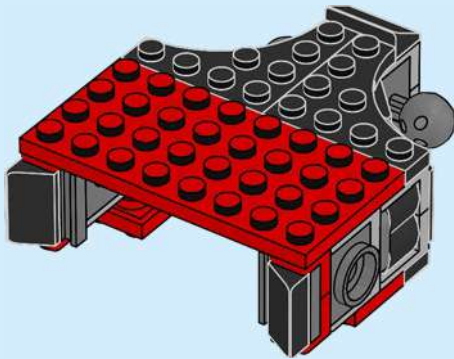

12

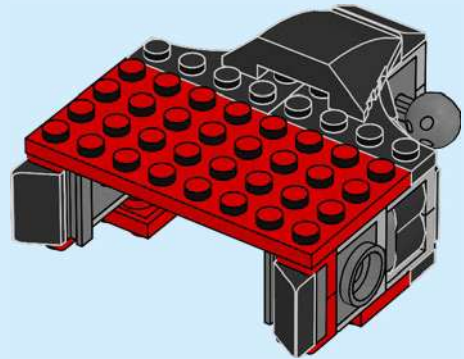

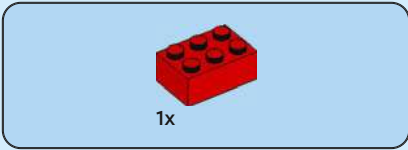

13

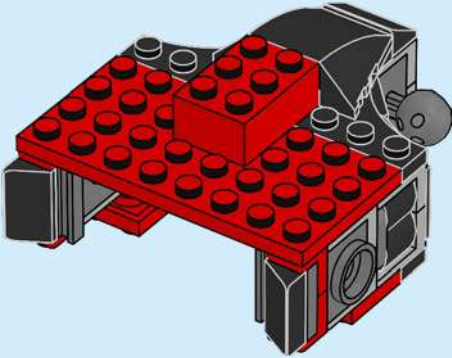

14

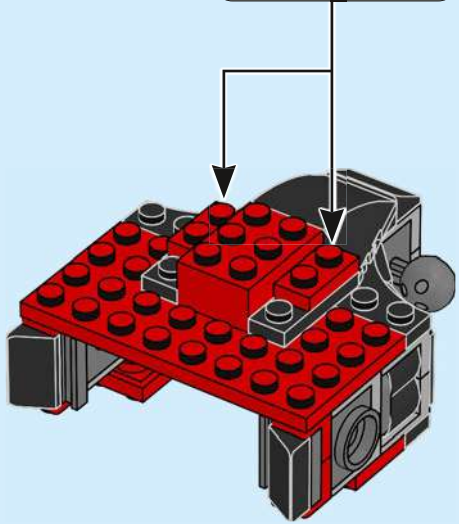
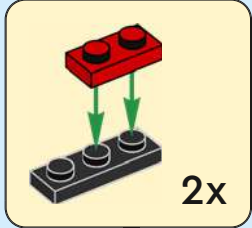

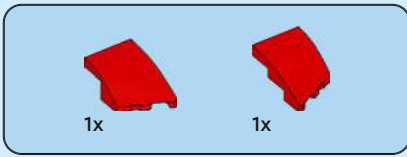

15

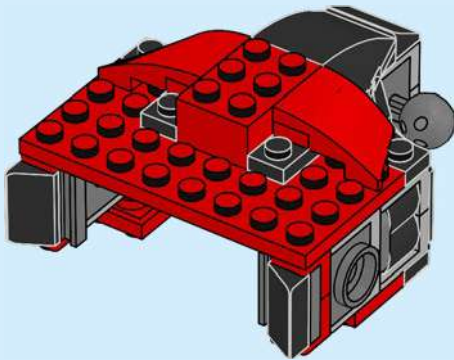

16

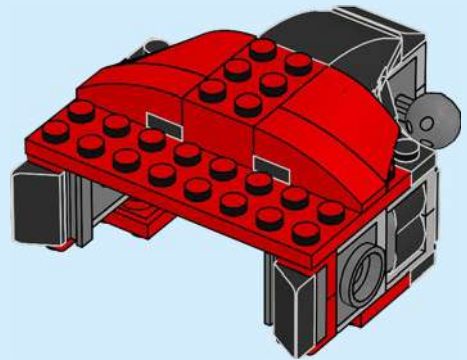



1x



1x

17

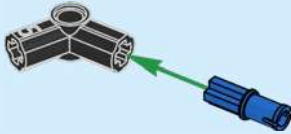

1x

18



1x



1x



1x

19

1

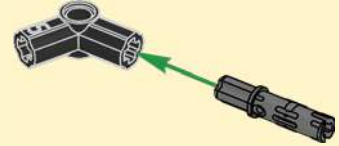

2

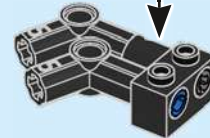
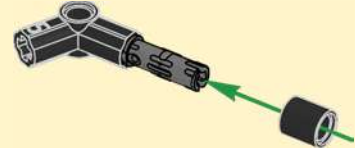



20



21



22

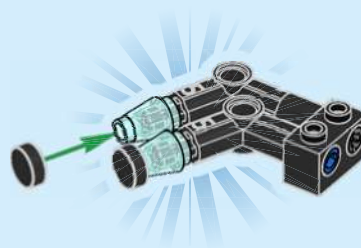

23

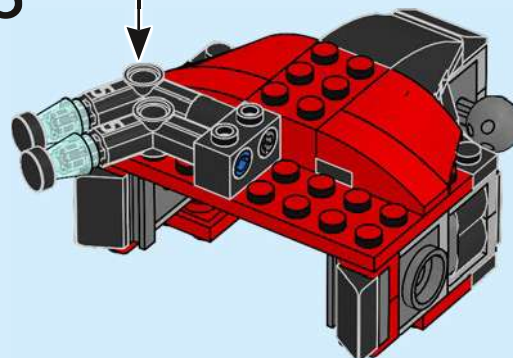

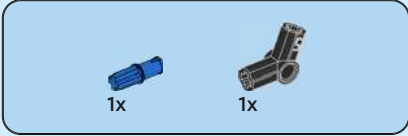

24

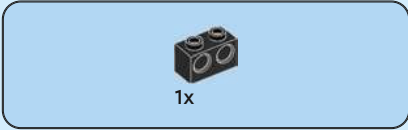
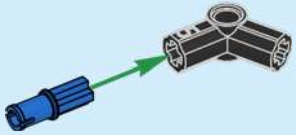

25

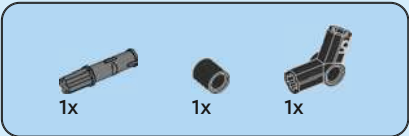

26

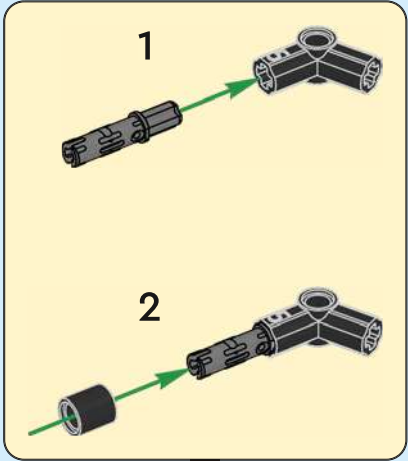



2x

27



2x

28



2x

29

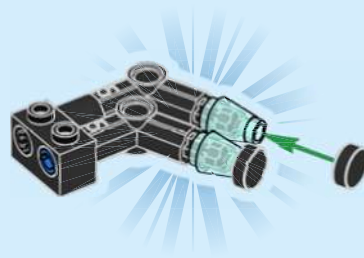

2x

30

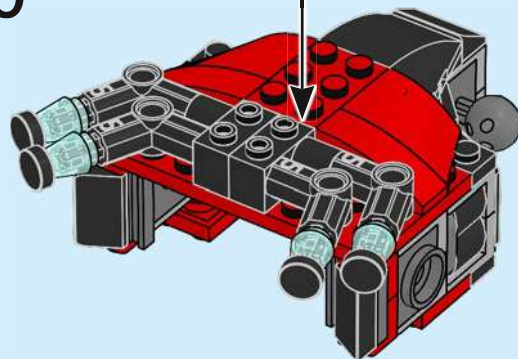



2x



2x

# 31

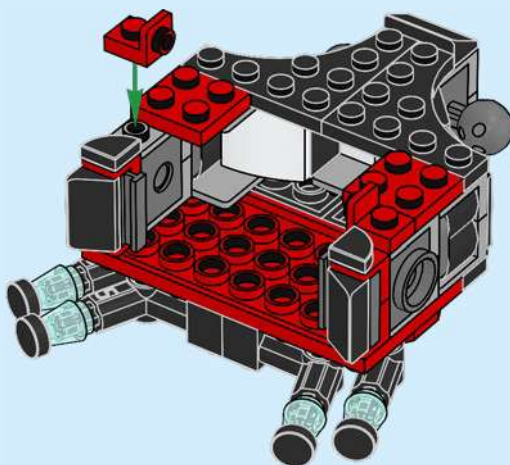

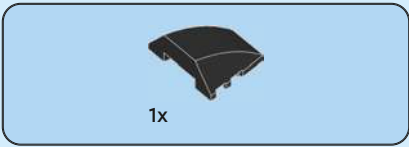

32

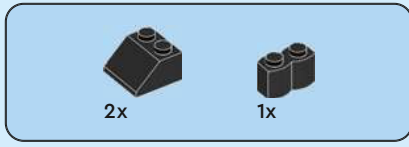
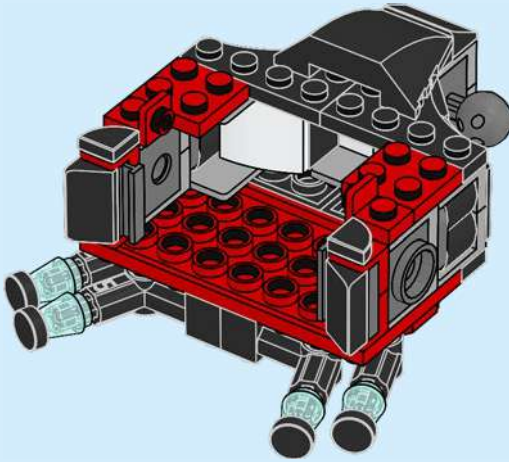

33

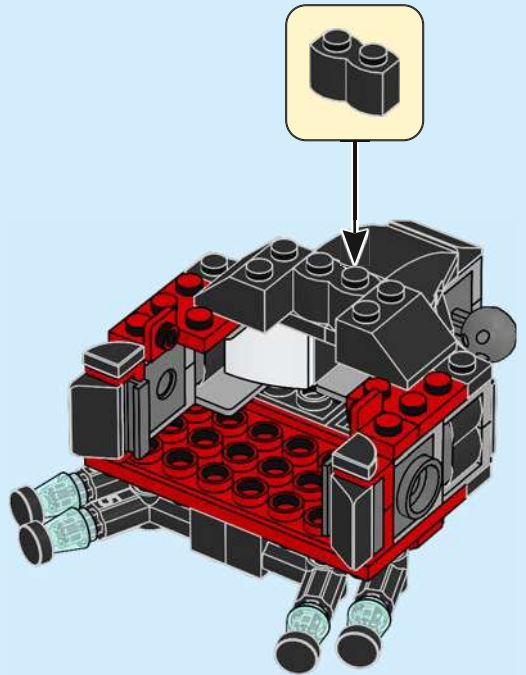

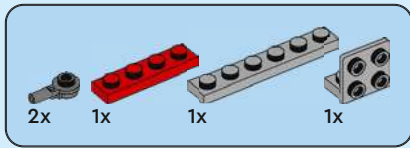

34

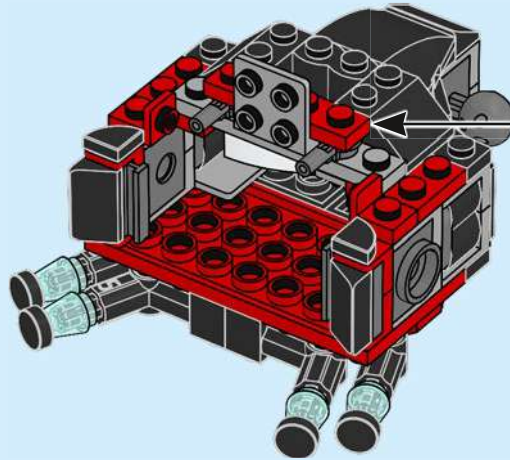
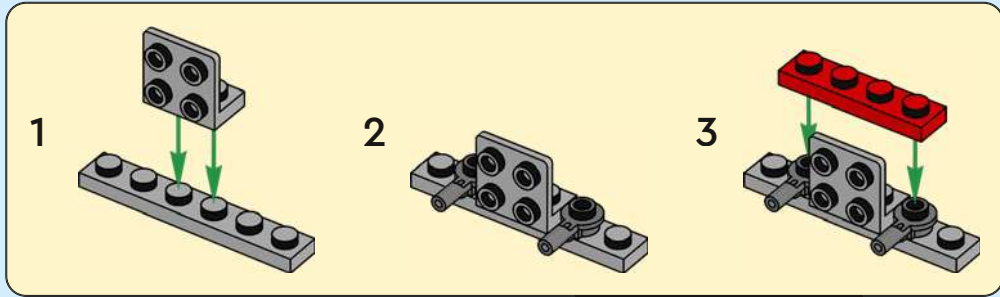

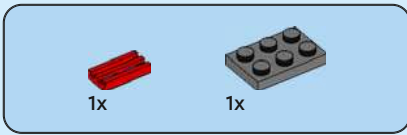

35

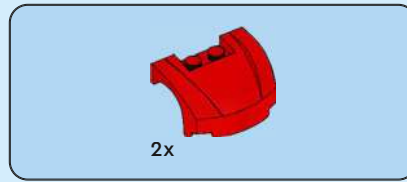
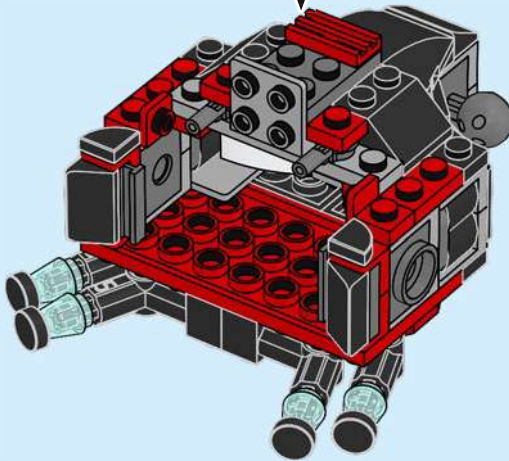
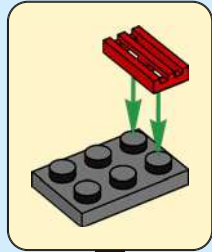

36

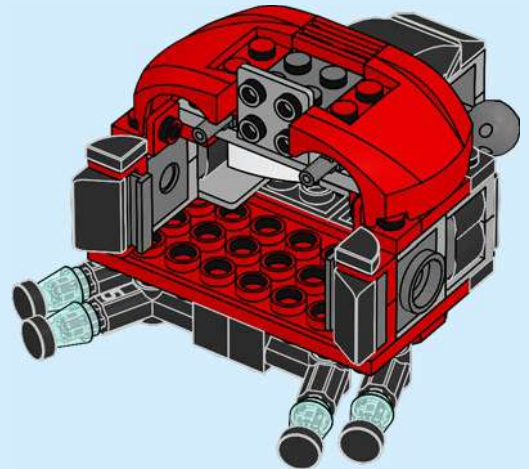

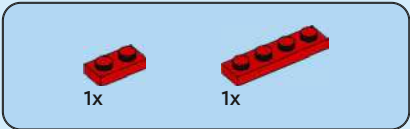

37

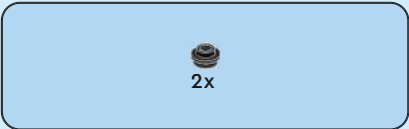
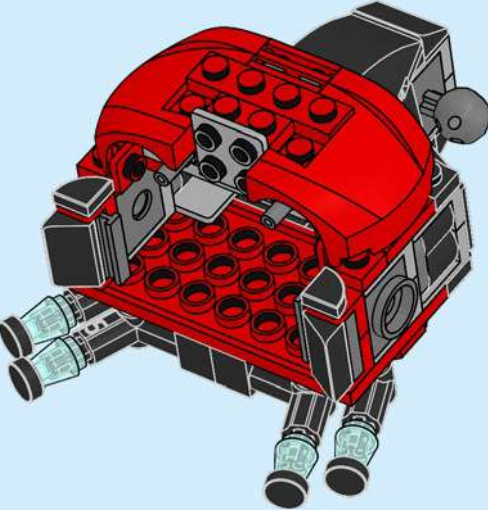

38

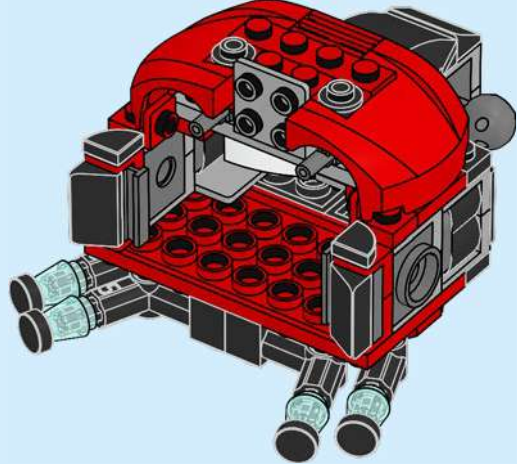



1x



2x

39

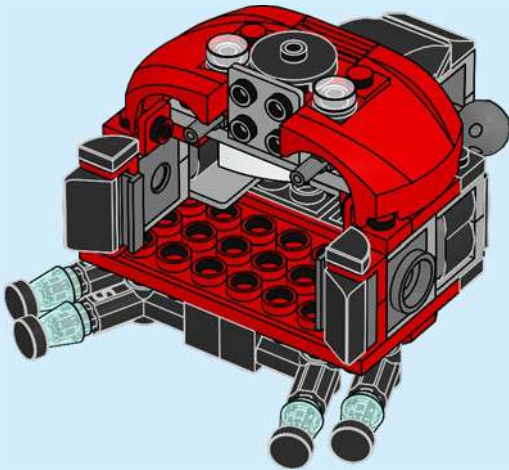

1x

40

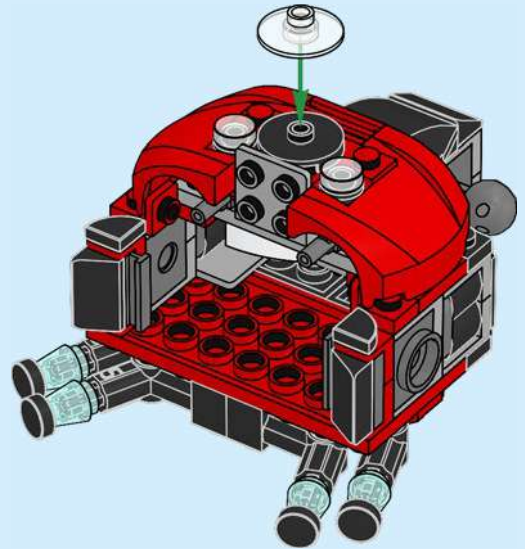

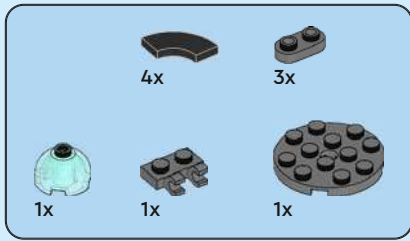

41

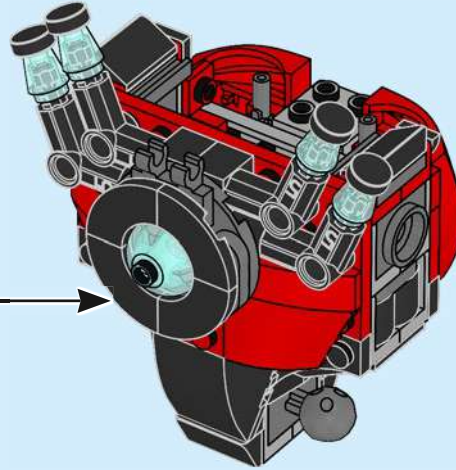
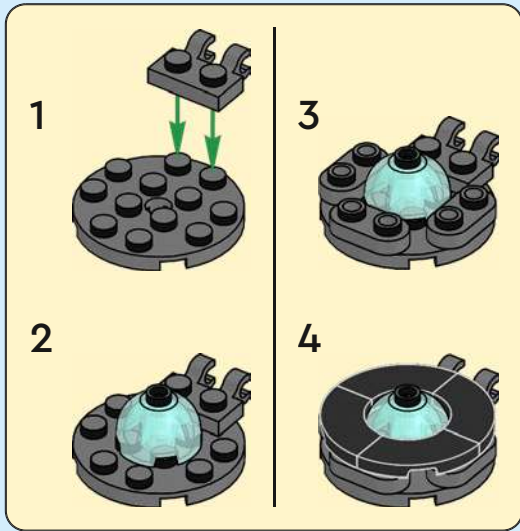



2x



1x



1x

# 42

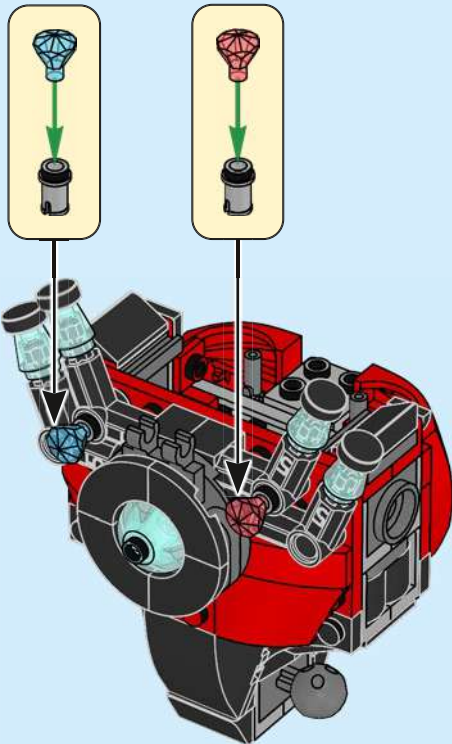

1x

# 43

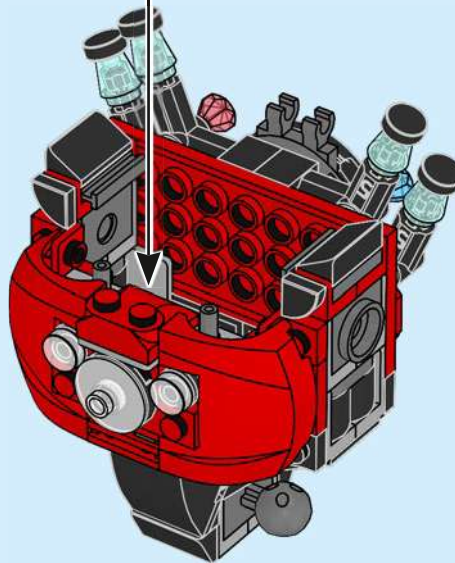
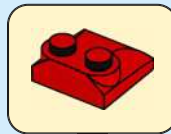
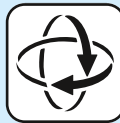

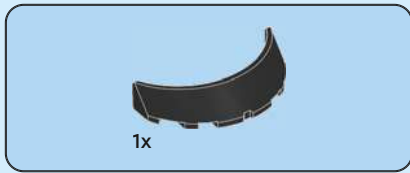

44

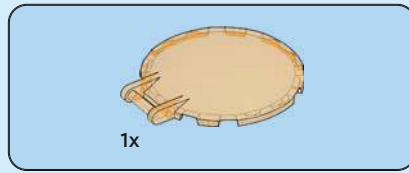
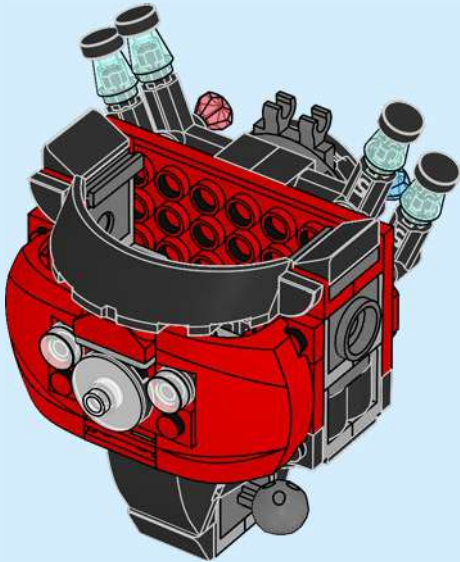

45

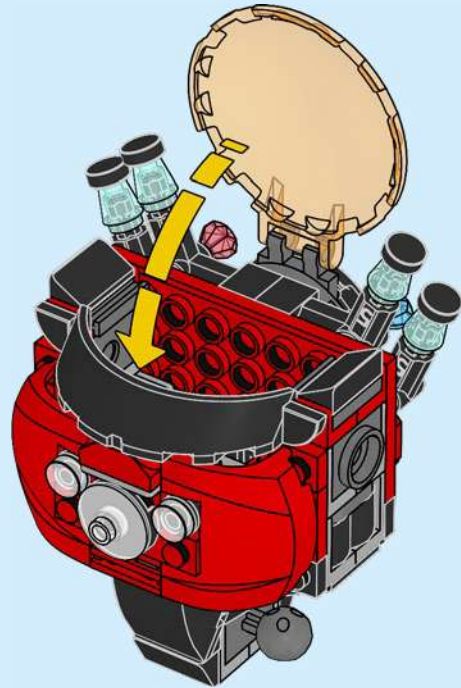

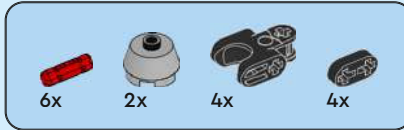

46

1



2



3

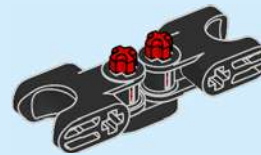

4



5



2x

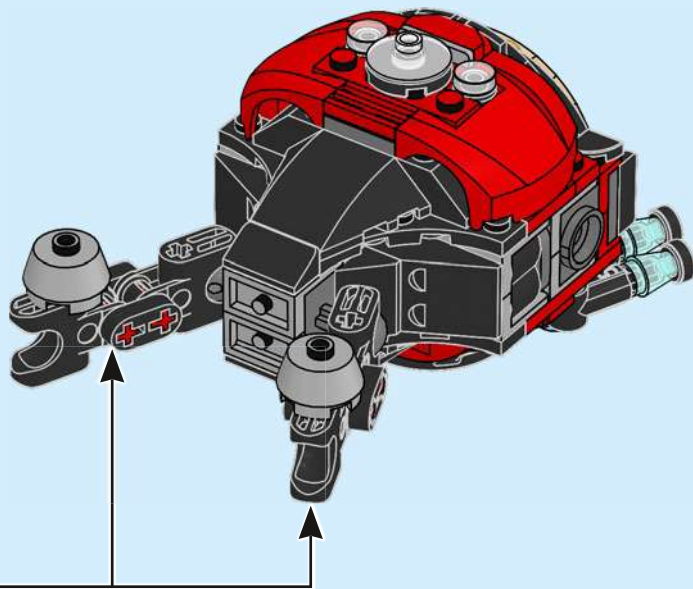



2x



1x

47

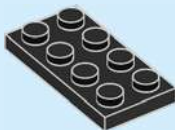

1x

48

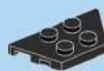

1x

49



2x

50





51

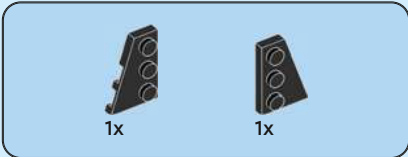
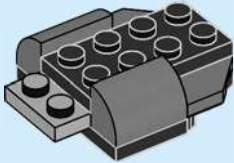

52

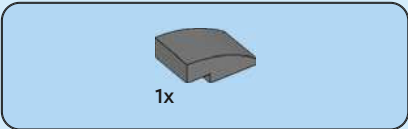
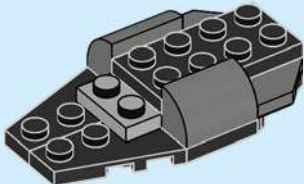

53

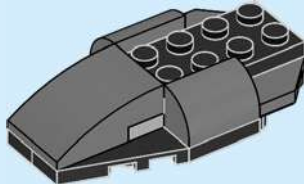

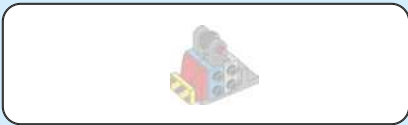

54

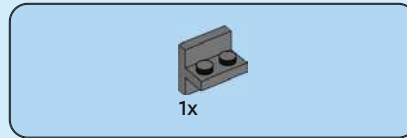
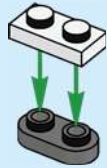

55



56

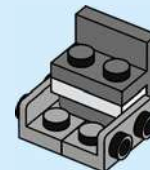



57

1

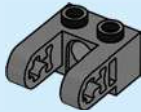

2

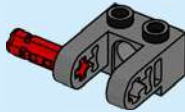

3

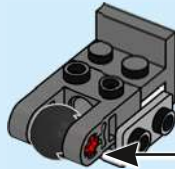
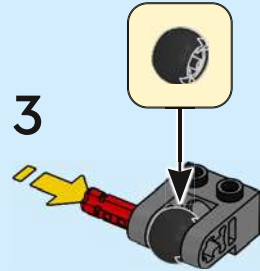



2x

58

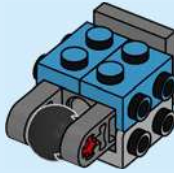

1x



1x

59

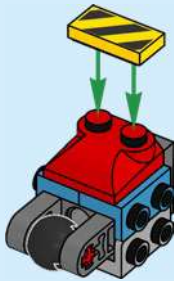

1x



1x

60

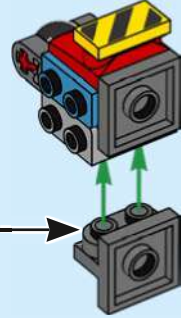
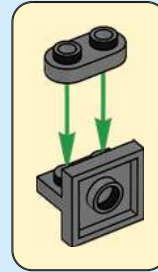
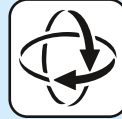

61

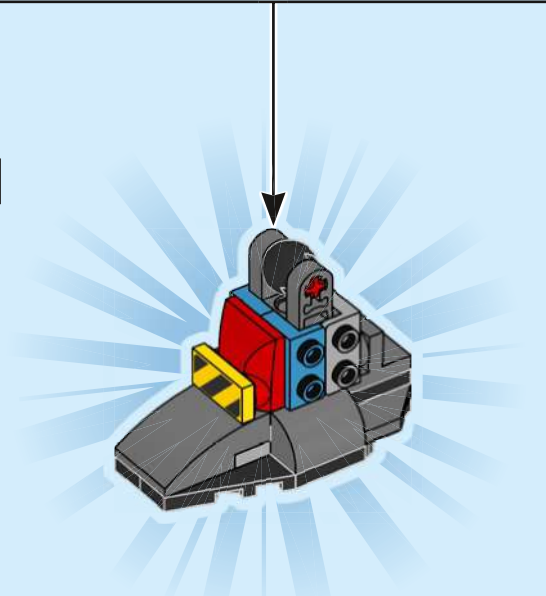



2x

2x

62

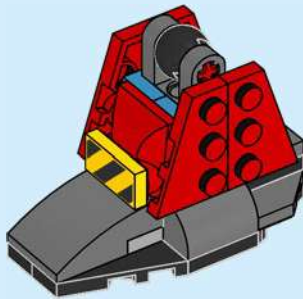

2x



2x

63

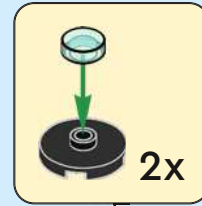

2x

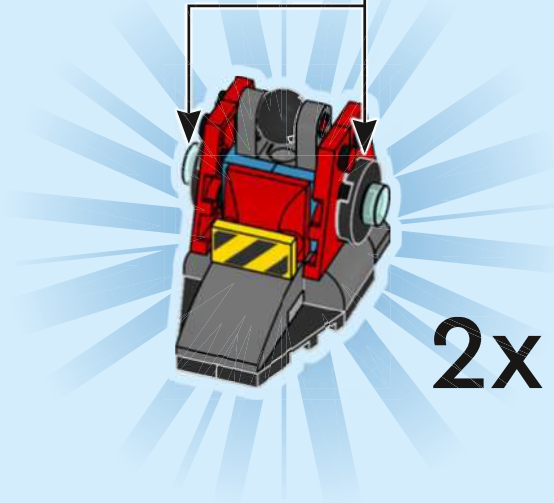

2x

64

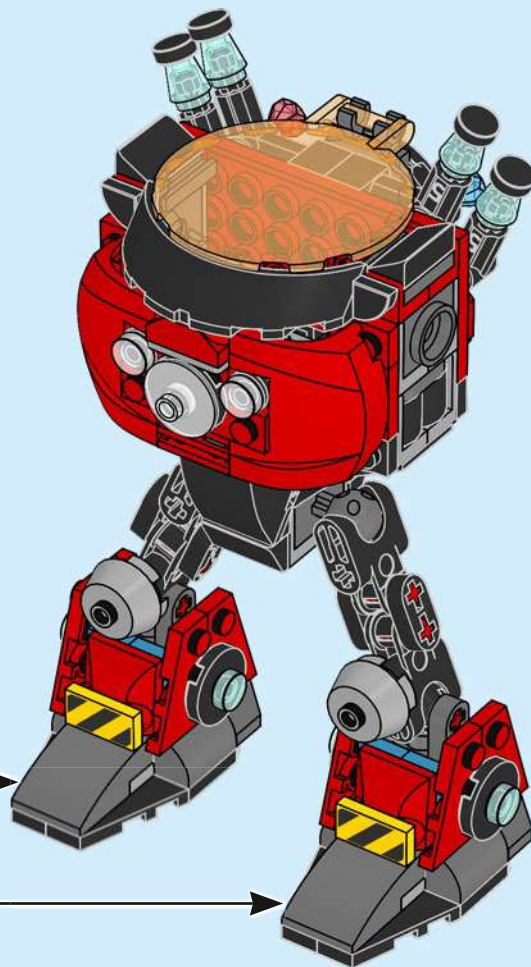

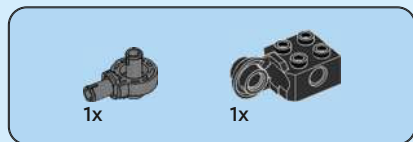

65

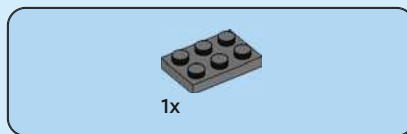
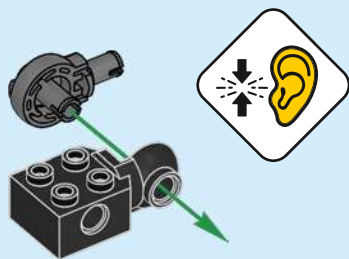

66

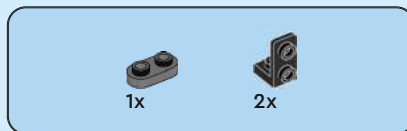
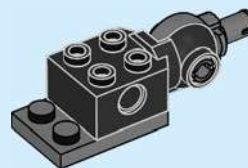

67

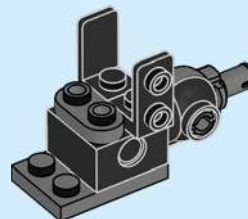

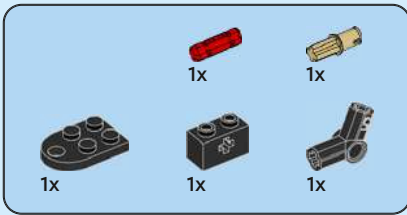

68

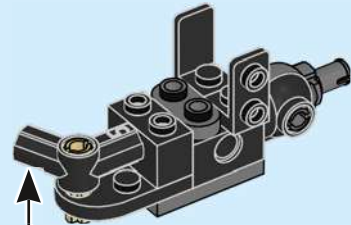
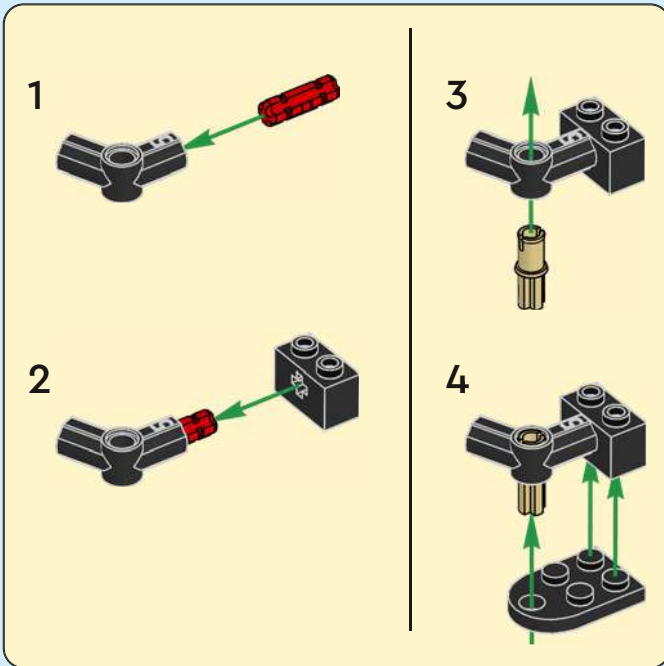

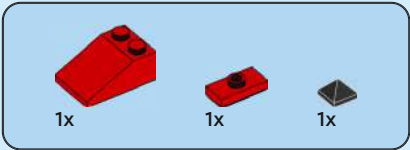

69

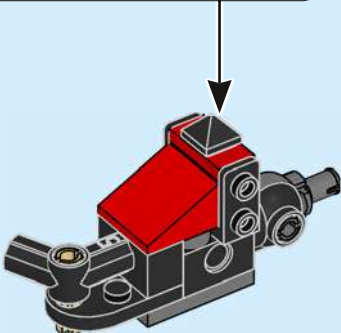
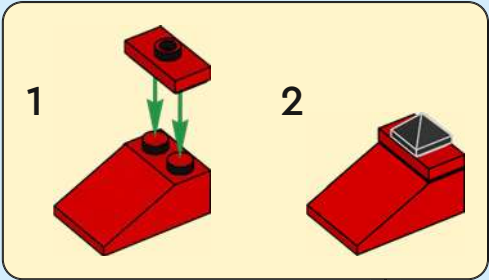

70

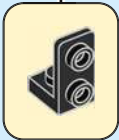
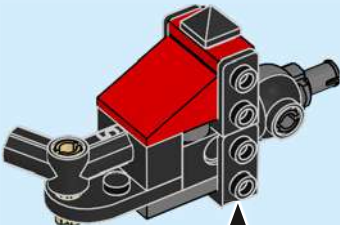



71

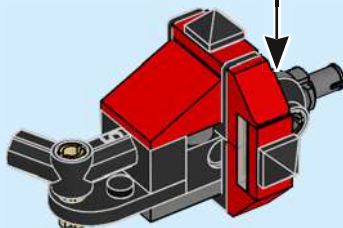
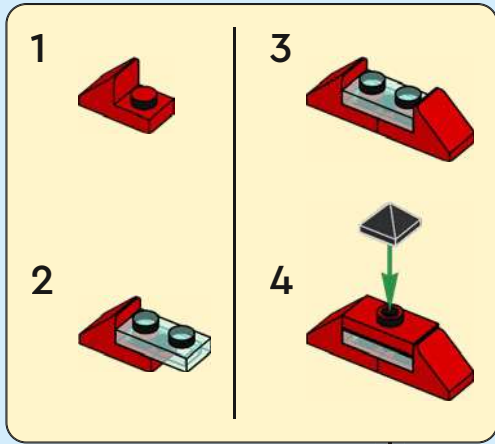

72

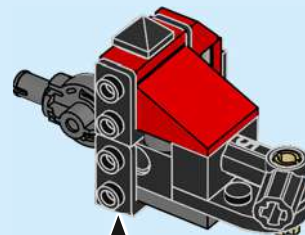
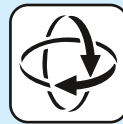



73

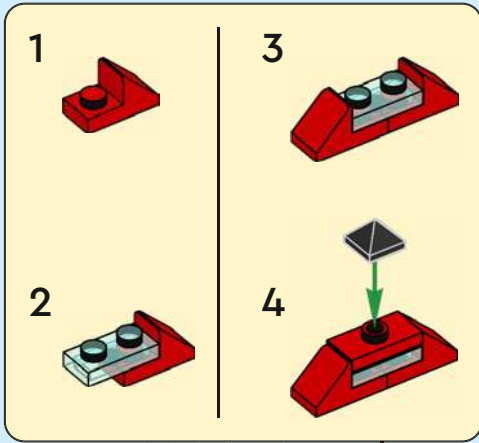

74

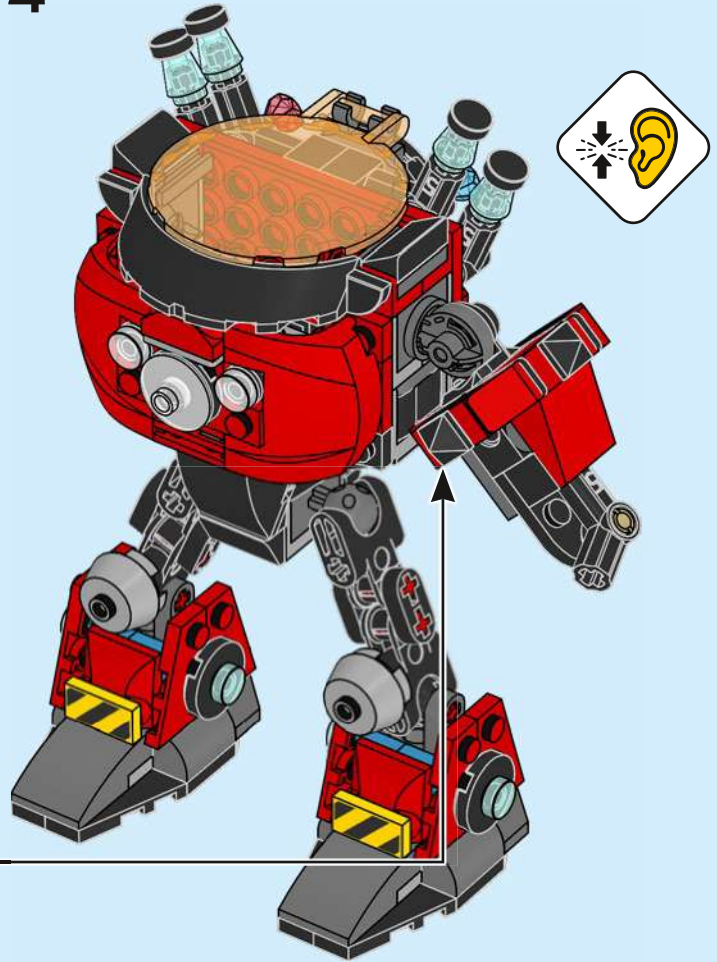

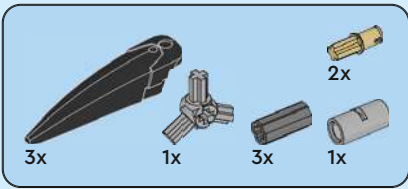

75

1

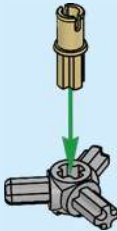

2

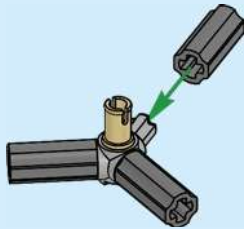

3

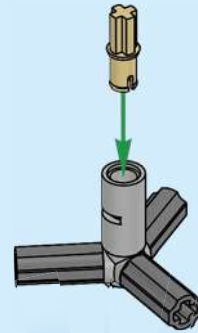

4

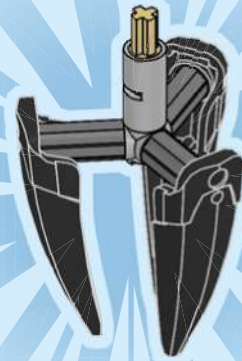

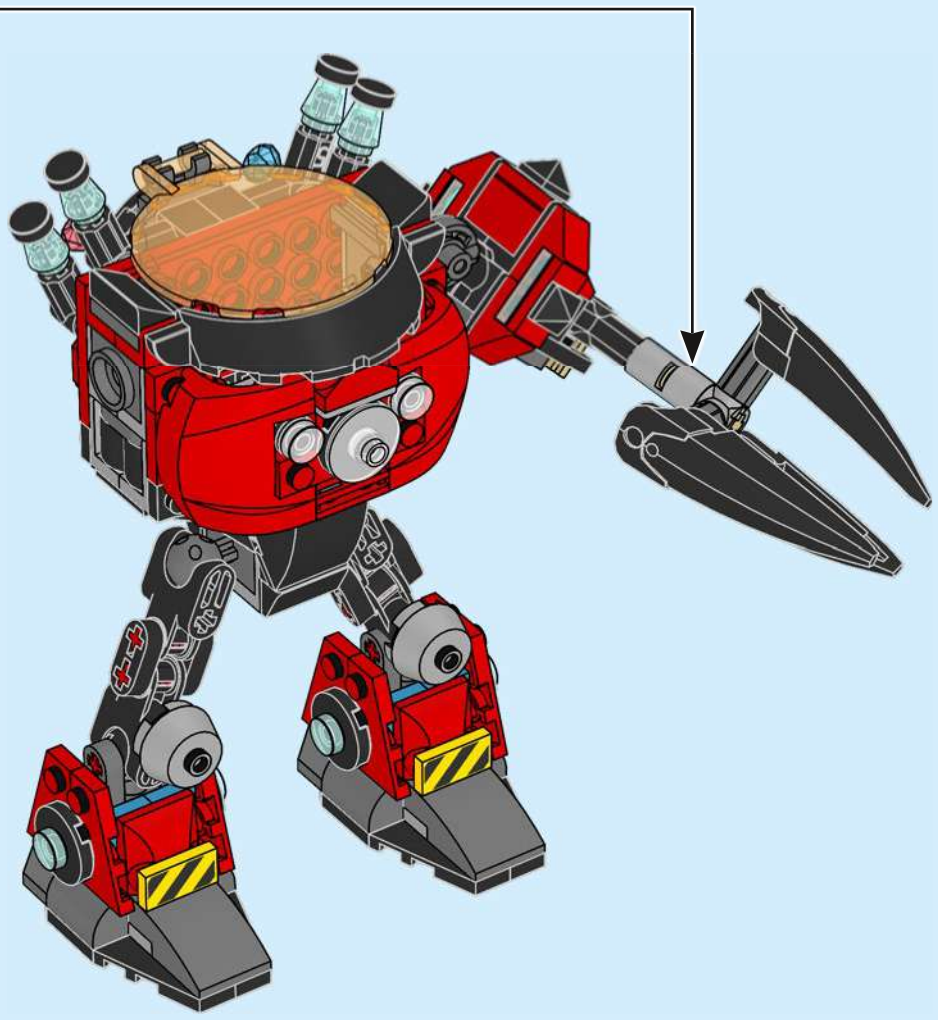

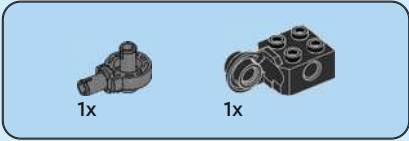

76

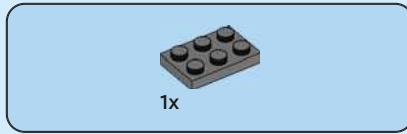
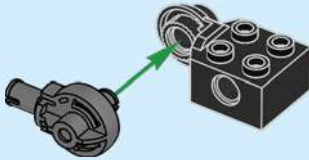

77

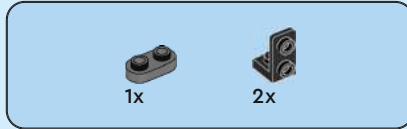
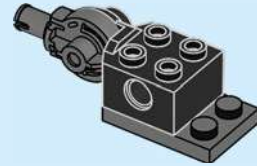

78

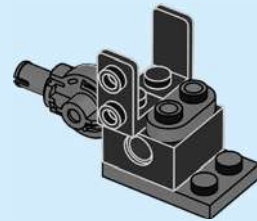

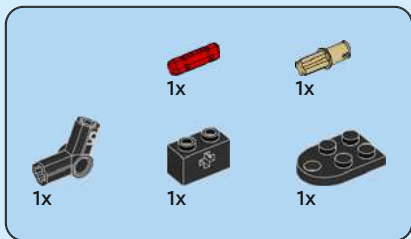

79

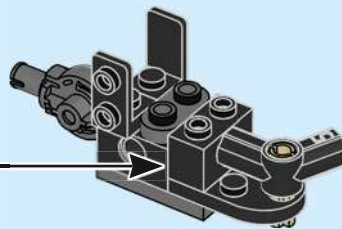
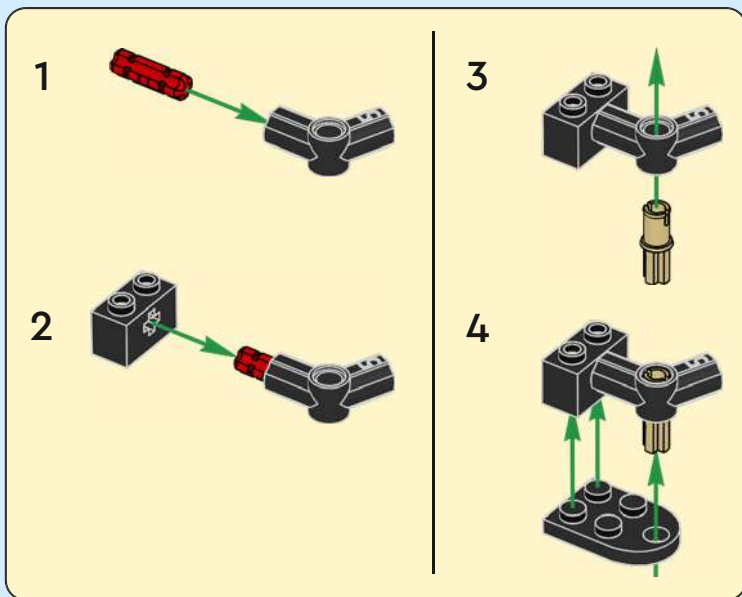

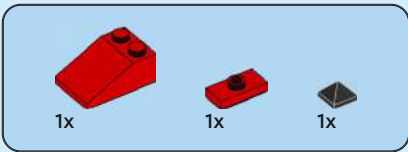

80

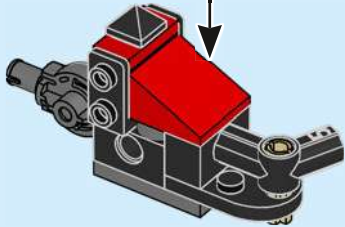
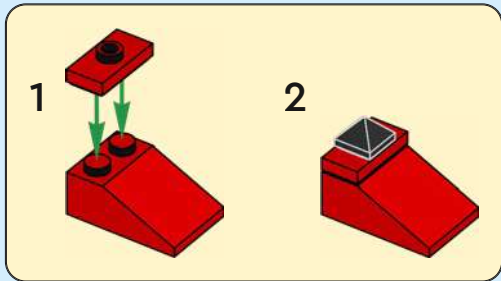

81

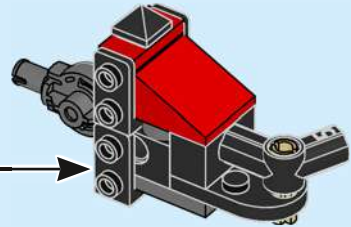



82

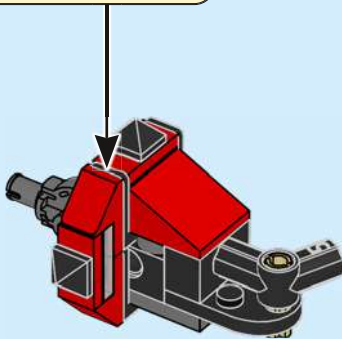
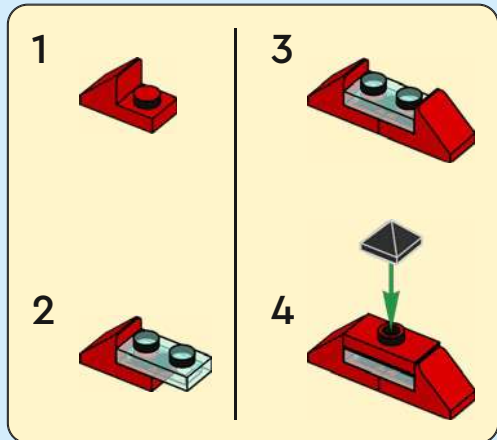

83

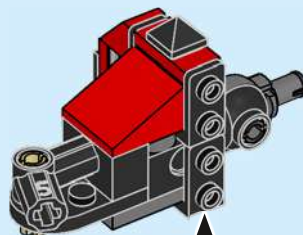



2x



1x



1x



1x

# 84

1



3



2



4

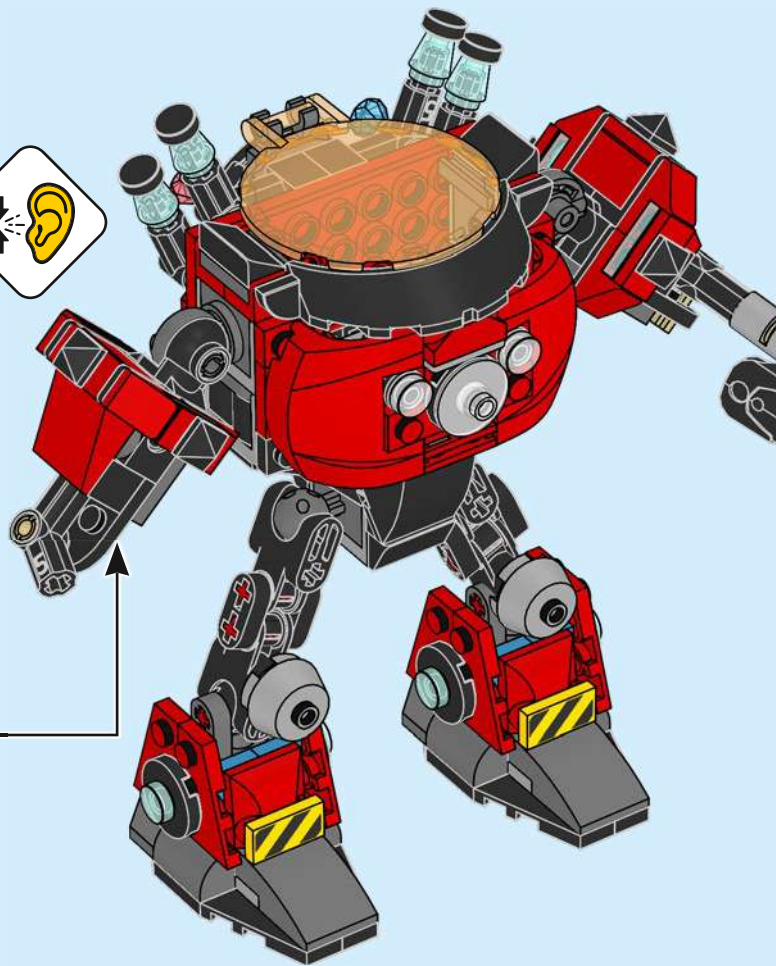
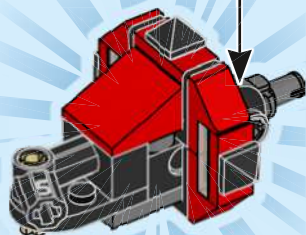
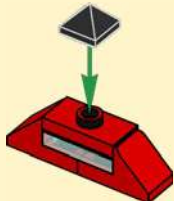

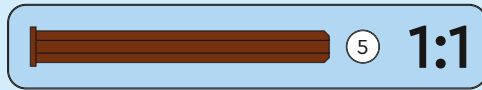
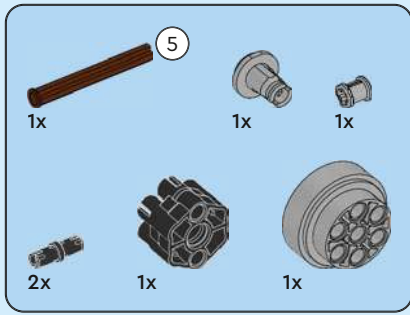

85

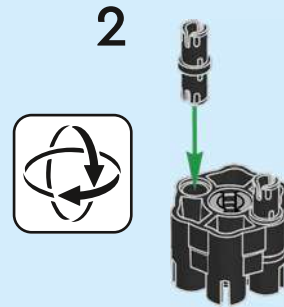
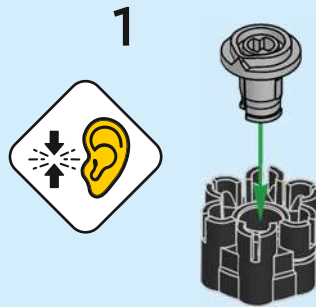

3



4

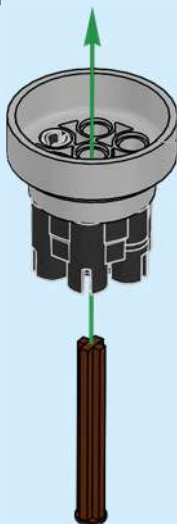

5

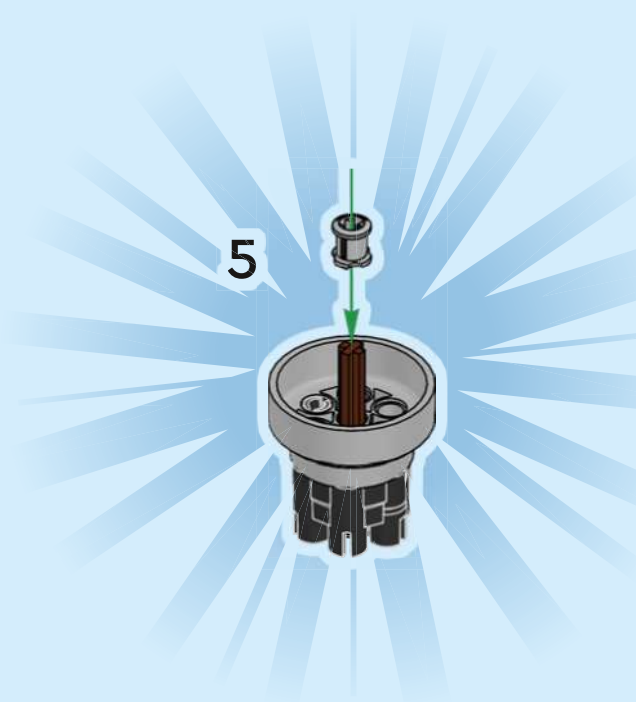

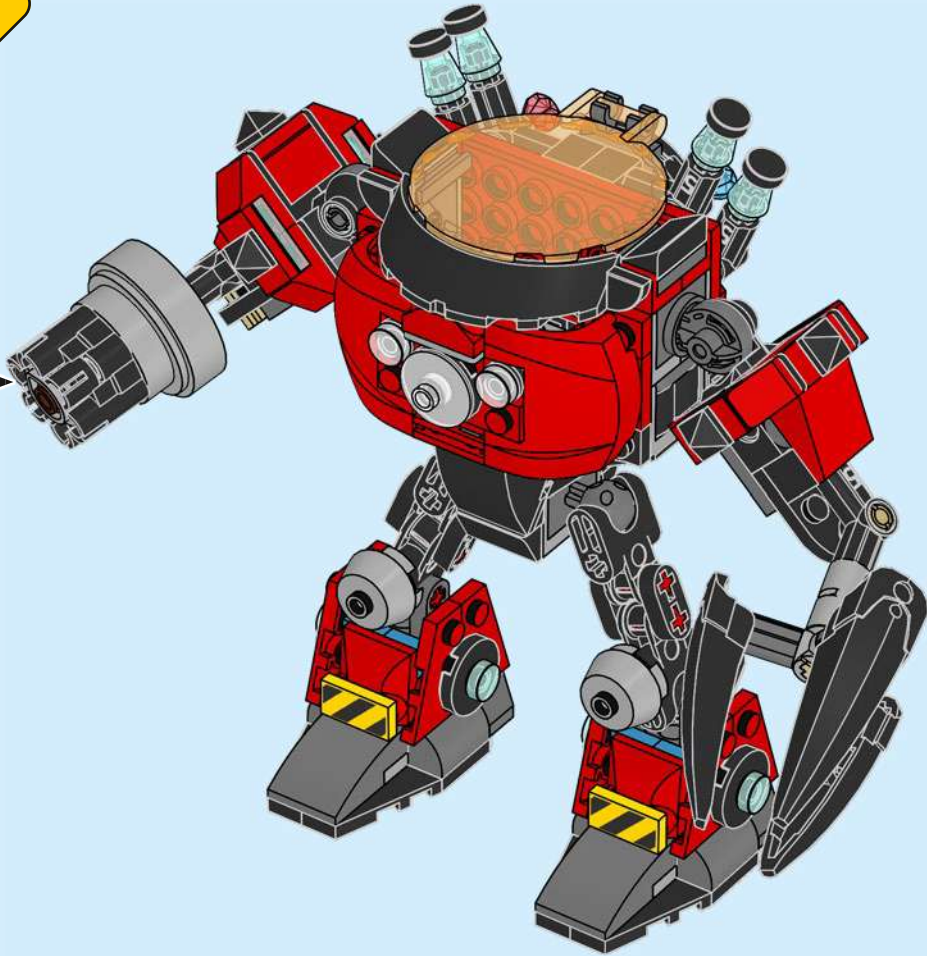

12x

86

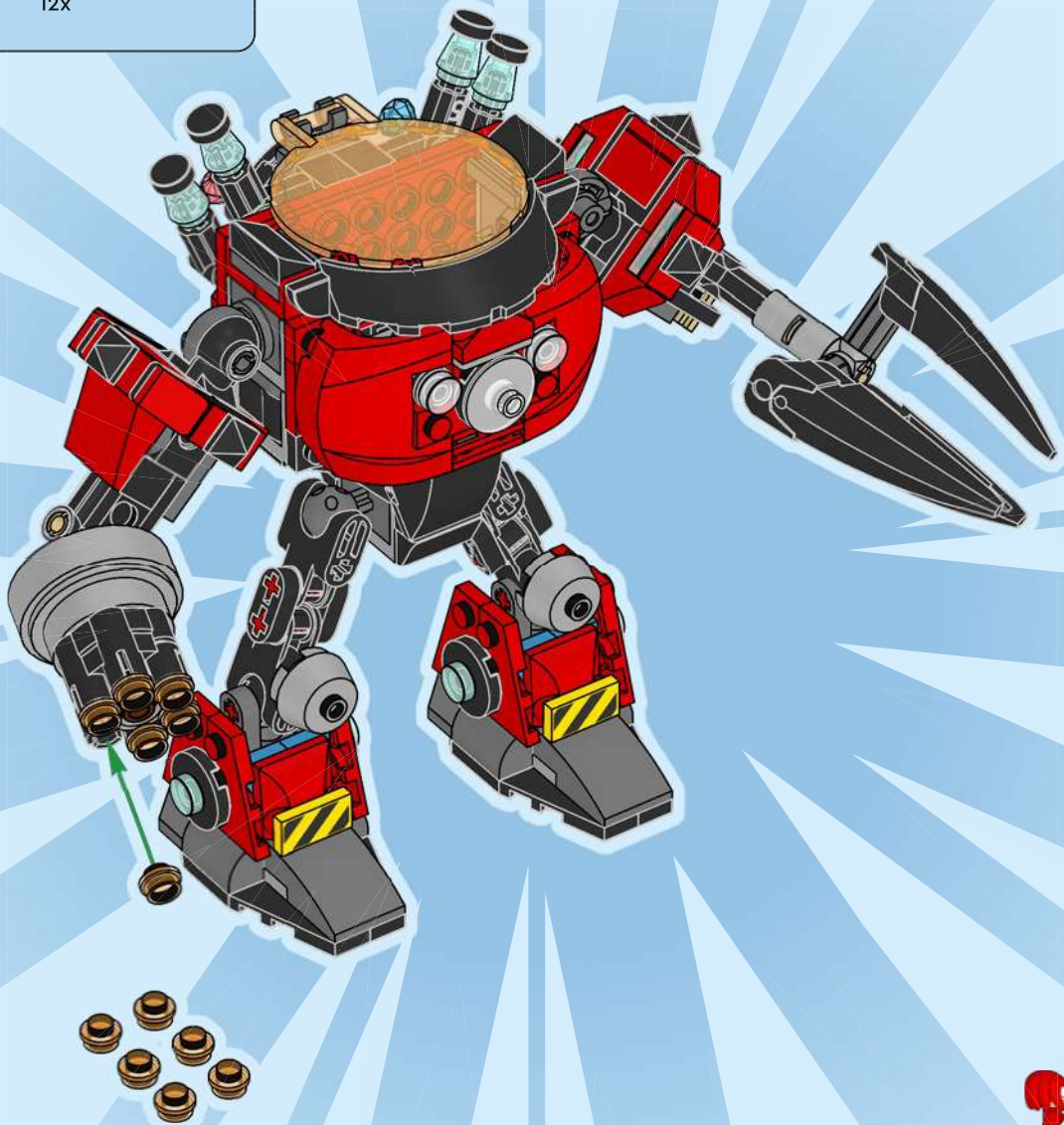

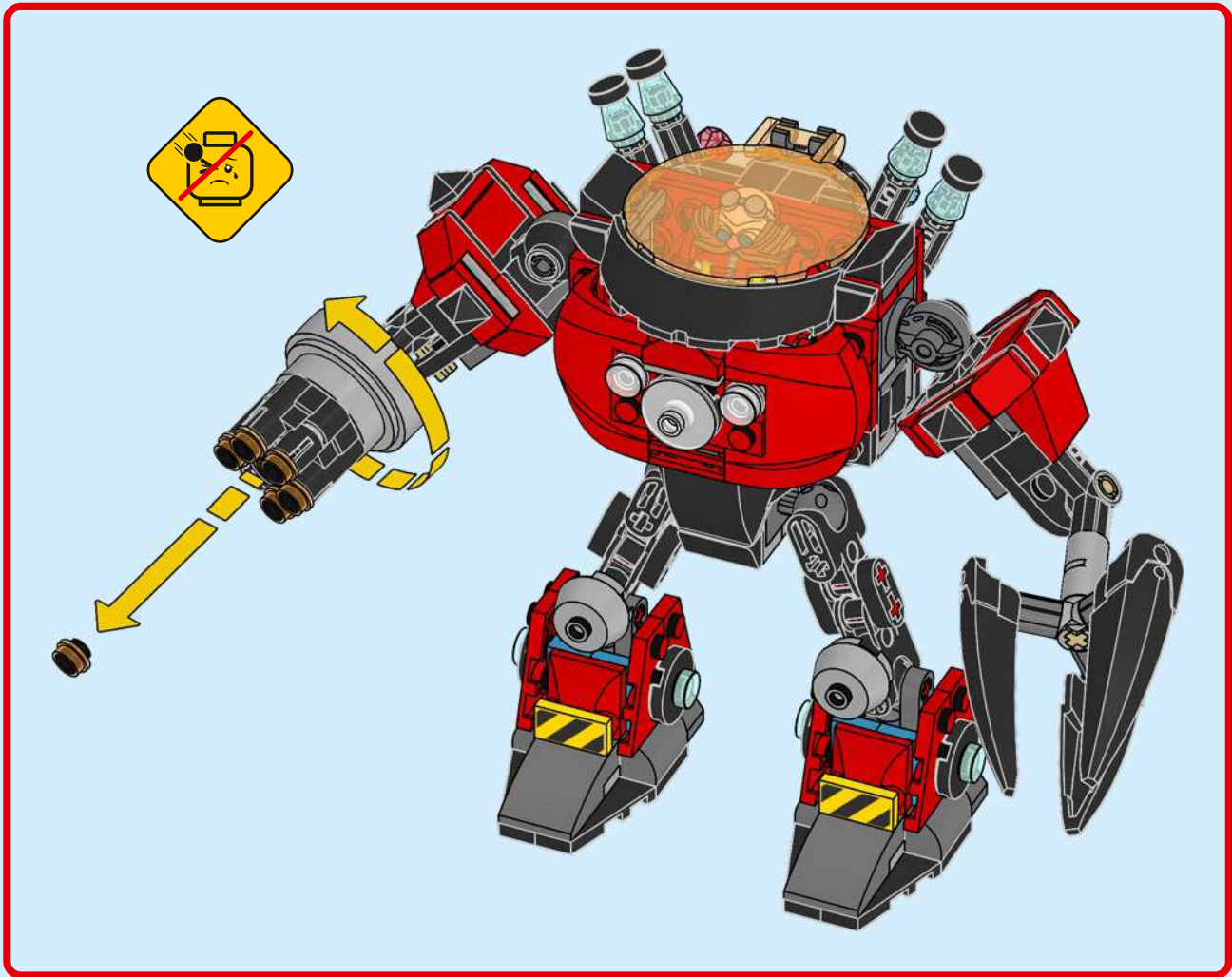

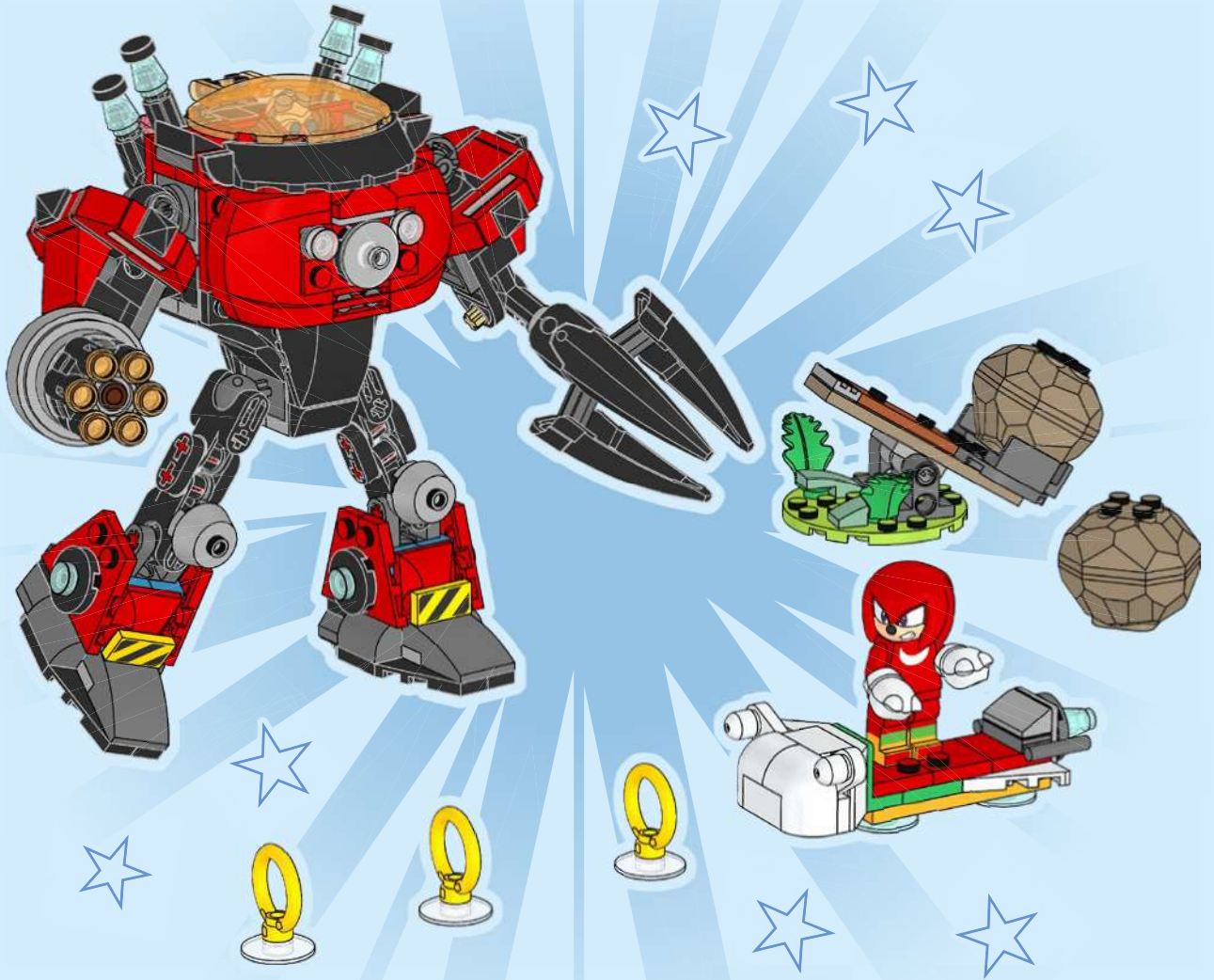



# SONIC™

THE HEDGEHOG



77002



77001



77003







































































**EXPLORE MORE**  
**DÉCOUVRIR PLUS**  
**EXPLORAMÁS**



 [LEGO.com/sonic](https://www.lego.com/sonic)

©SEGA. All rights reserved. SEGA is registered in the U.S. Patent and Trademark Office.  
SEGA and SONIC THE HEDGEHOG are either registered trademarks or trademarks of SEGA CORPORATION.



 2x 6448949	 6x 6249907	 1x 6443218	 1x 6528046	 2x 6168646	 4x 6338289	 1x 6360819
 2x 302401	 6x 6092565	 1x 6492337	 8x 6053011	 4x 6284070	 6x 6271346	 2x 6302828
 2x 6431337	 10x 4142865	 1x 6474530	 3x 302321	 6x 6312449	 2x 303926	 2x 362326
 3x 6210272	 1x 241221	 1x 6508124	 4x 4180504	 2x 6172383	 2x 303926	 2x 6009018
 2x 6051511	 2x 4251162	 1x 6508124	 4x 4180533	 2x 6121485	 2x 6435928	 2x 6009018
 1x 306901	 1x 6527749	 2x 329821	 4x 4180533	 2x 4286267	 2x 4531412	 1x 4188534
 2x 302301	 3x 6219819	 1x 300221	 2x 4180508	 4x 4109810	 2x 317626	 4x 302026
 2x 6047220	 3x 4220515	 2x 371021	 2x 4180536	 2x 6178922	 1x 6443216	 4x 6208787
 1x 300301	 2x 302221	 2x 6422923	 4x 6338428	 3x 4644456	 4x 6191630	 1x 6560521
 1x 6170524	 1x 6436412	 1x 303521	 2x 6279875	 4x 4548180	 2x 3200026	 3x 6297810
 1x 4173943	 1x 6436413		 5x 6195325	 8x 6335317		
 2x 6519991						

2x  
4206482

2x  
6514191

1x  
6507912

1x  
4211350

4x  
4666579

4x  
6177079

4x  
6250018

1x  
6493342

4x  
6514246

1x  
6097509

1x  
6361703

4x  
4529237

1x  
6350292

2x  
6501502

2x  
6581711

1x  
6513969

1x  
6159763

2x  
6028324

2x  
6329649

2x  
6015356

2x  
4522784

1x  
302228

4x  
6514192

1x  
6275844

1x  
4568637

3x  
6508325

2x  
4543086

1x  
4263176

1x  
6288614

1x  
6133836

2x  
4211525

10x  
4654580

4x  
6152101

3x  
4516546

3x  
4211043

5x  
6514027

2x  
6555150

2x  
4211483

1x  
4211376

3x  
6146225

4x  
6302690

2x  
4528323

2x  
6580378

2x  
6555149

4x  
6345639

1x  
4502595

2x  
6398662

2x  
6324639

1x  
6065816

4x  
6514007

1x  
4246957

1x  
6173127

2x  
4211395

2x  
6388118

1x  
6507968

2x  
6196591

4x  
6004990

1x  
4511007

11x  
6221607

1x  
6513973

12x  
6514059

2x  
4211807

1x  
4211438

1x  
6115080



 [LEGO.com/service](https://www.LEGO.com/service)

YOU COULD **WIN**



Scan this QR code or go to  
**LEGO.COM/PRODUCTFEEDBACK** and give us  
your short feedback about this LEGO® set  
for a chance to win a cool LEGO prize.

Terms and Conditions apply\*

**EN: YOU COULD WIN.** Terms and Conditions apply\* **DE: Du könntest GEWINNEN.** Es gelten die Teilnahmebedingungen\* **FR: Tu pourrais GAGNER.** Des conditions s'appliquent\* **IT: Potresti VINCERE tu.** Termini e condizioni sono applicabili\* **ES: Puedes GANAR.** Aplican términos y condiciones\* **PT: PODERÁ GANHAR.** Aplicam-se Termos e Condições\* **ZH: 轻松获奖.** 条款和条件适用\* **PL: Szansa na WYGRANĄ.** Obowiązuje regulamin\* **CS: Máte šanci VYHRÁT.** Platí všeobecné smluvní podmínky\* **SK: Máte šancu VYHRAŤ.** Platia všeobecné zmluvné podmienky\* **HU: TE IS NYERHETSZ.** Felhasználási feltételek érvényesek\* **UA: ВИ МОЖЕТЕ ВИГРАТИ.** Застосовуються загальні положення та умови\* **RO: Ai putea CÂȘTIGA.** Se aplică termeni și condiții\* **BG: Можете да СПЕЧЕЛИТЕ.** Има определени правила и условия\* **LV: Tu vari LAIMĒT.** Ir spēkā noteikumi un nosacījumi.\* **ET: Sul on võimalus VÕITA.** Kehtivad tingimused\* **LT: Jūs galite LAIMĖTI.** Taikomos sąlygos\*  
*\*LEGO.com/productfeedback-terms*

LEGO and the LEGO logo are trademarks of the/son des marques de commerce du/son marcas registradas de LEGO Group. ©2025 The LEGO Group.

©SEGA. All rights reserved. SEGA is registered in the U.S. Patent and Trademark Office. SEGA and SONIC THE HEDGEHOG are either registered trademarks or trademarks of SEGA CORPORATION.

 6593076